



M24 CHAFFEE



★ **M24 CHAFFEE** ★
 IN SERVICE - 1944 - 1953
 PLACE OF ORIGIN - UNITED STATES
 TYPE - LIGHT TANK
 WEIGHT - 18,4t (40,565LB)
 ARMOR - 38MM (1.5") MAX
 ARMAMENT - 75MM GUN M6 L/39,
 .50CAL BROWNING M2HB MACHINE GUN,
 2x .30-06 BROWNING M1919A4 MG
 ENGINE - 2x CADILLAC 544T24, 160kW (220HP)
 SPEED - 56KM/H (35MPH)
 CREW - 5



PAD PRINTED
 NO STICKERS

Printed in EU



WARNING: CHOKING HAZARD-
 Toy contains small parts.
 Not for children under 3 years.

2543

HISTORICAL COLLECTION

590 2

BE CAREFUL: NOTICE THE DIFFERENCE

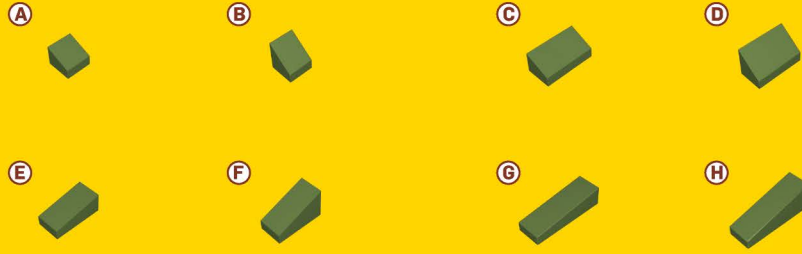

UWAGA: RÓŻNE KLOCKI



1

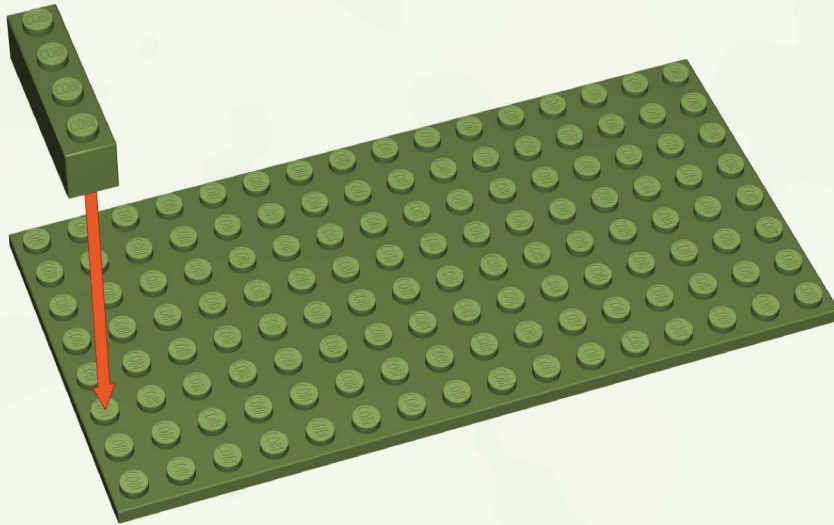

2

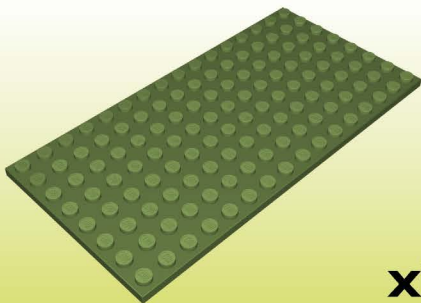
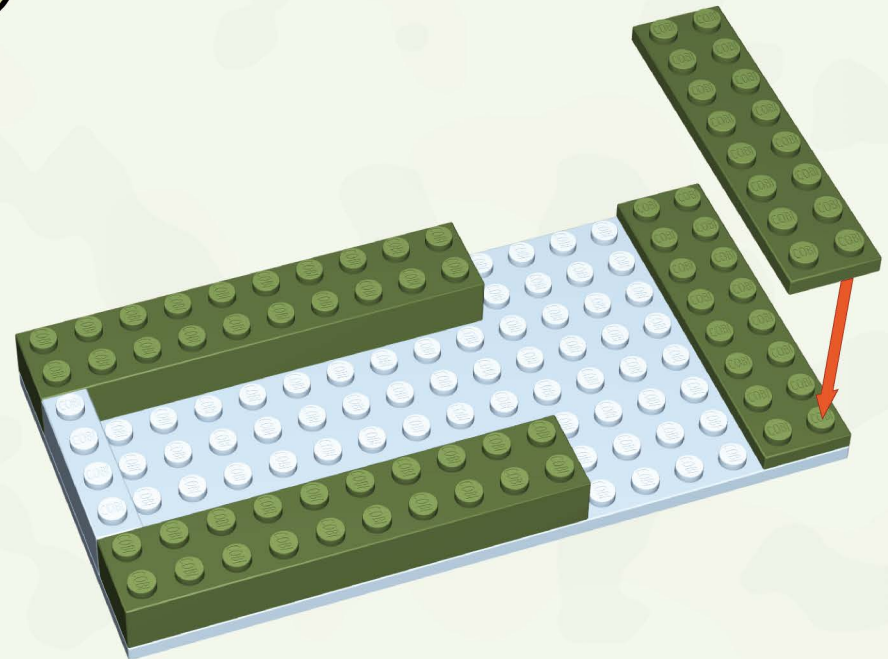

x1

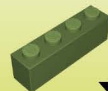

x1

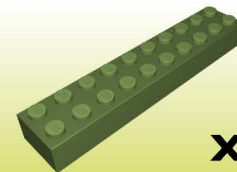

x2

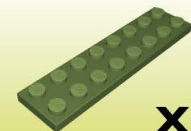

x2

3

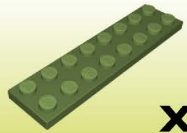
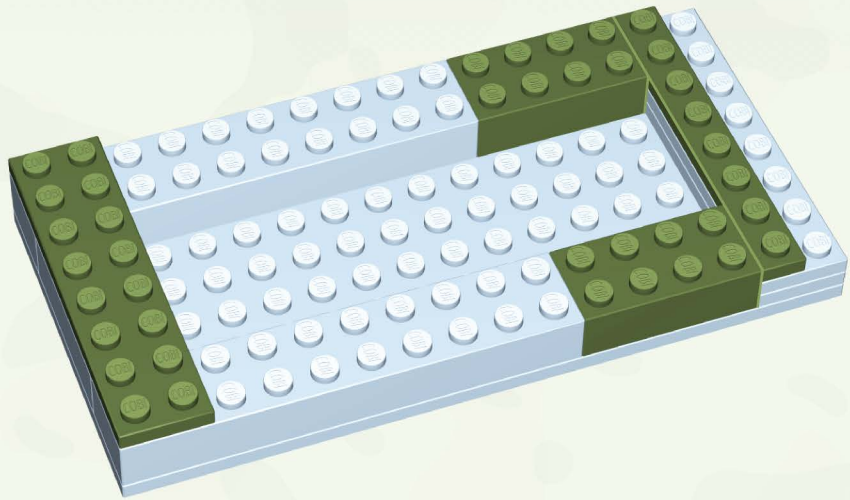

x1

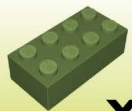

x2



x1

4

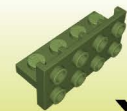
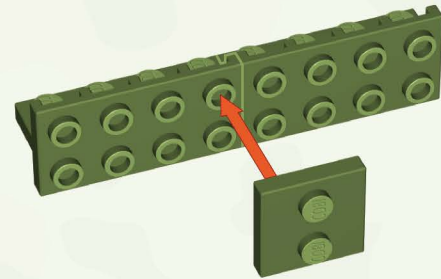

x2



x1

5

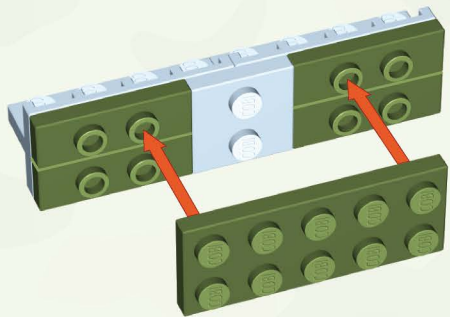

x4



x1

6



x2

7

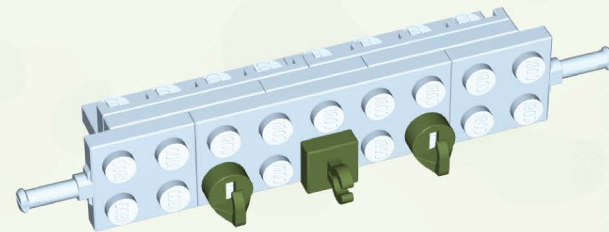

x2



x1

8

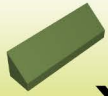
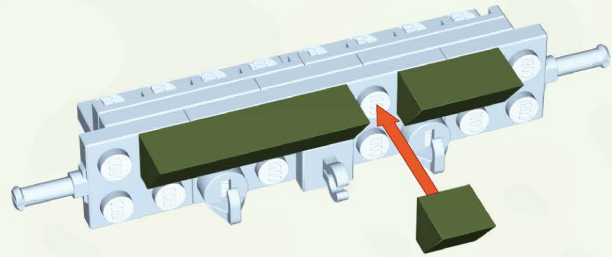

x1

Ⓓ



x1

Ⓑ



x1

9

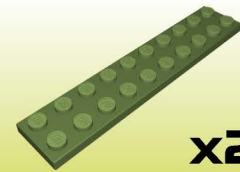
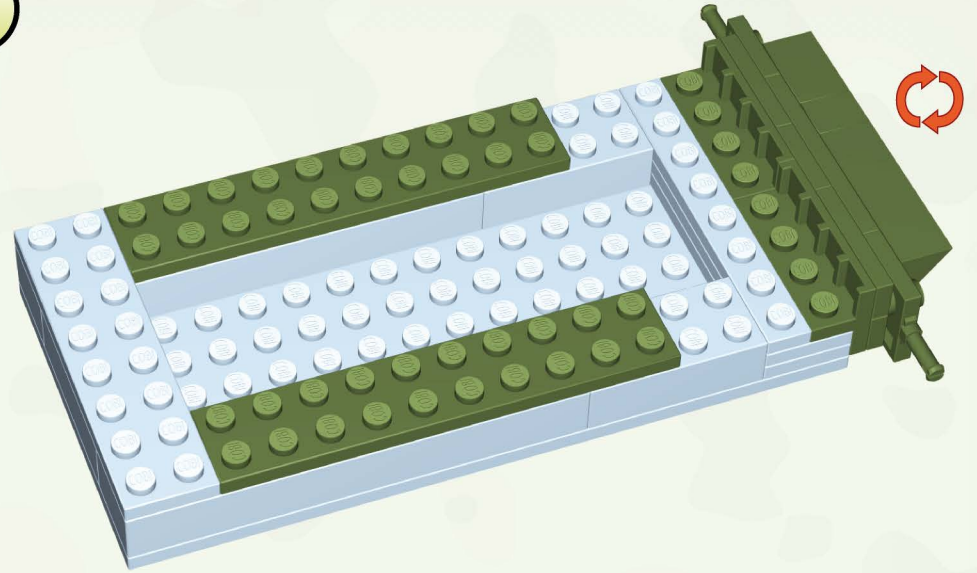

x2

10

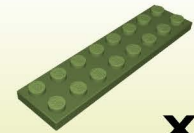
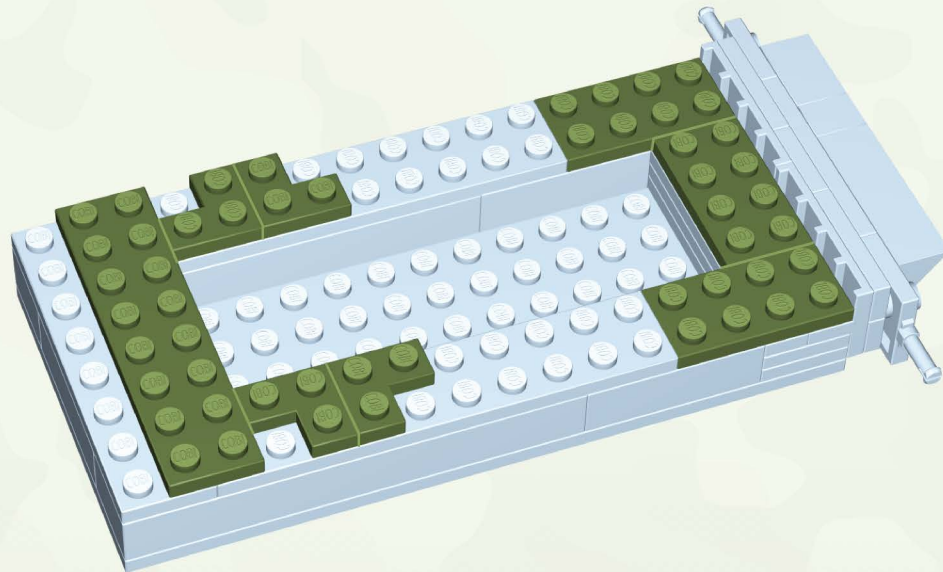

x1



x4



x3

11

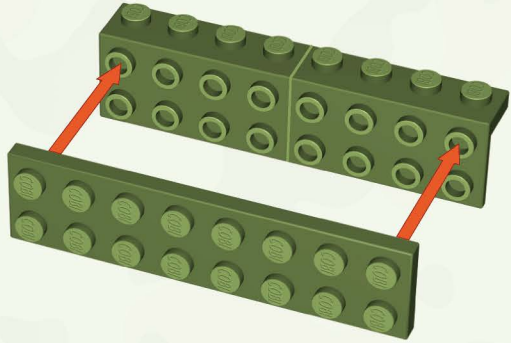

x2



x1

12

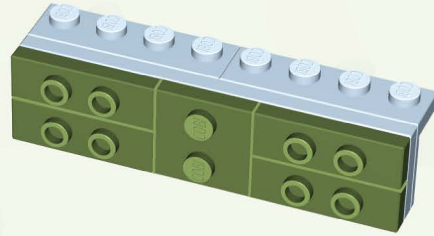

x4



x1

13

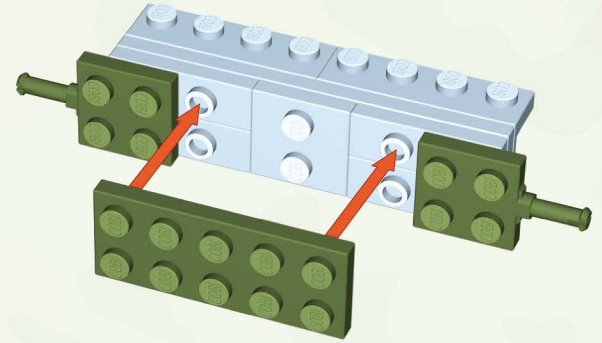

x2



x1

14

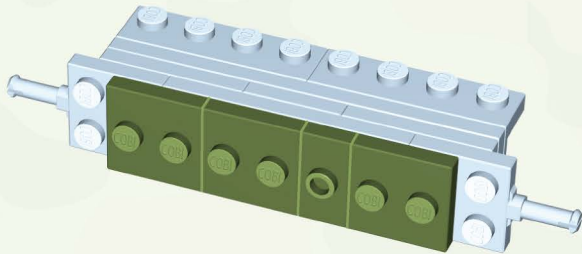

x3



x1

15

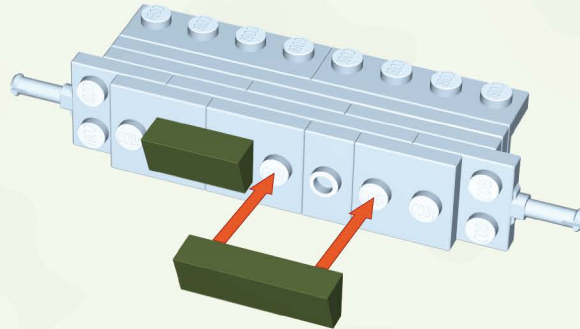

©



x1



x1

16

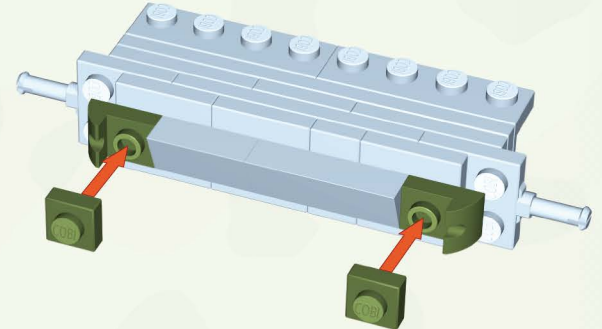

x2



x2

17

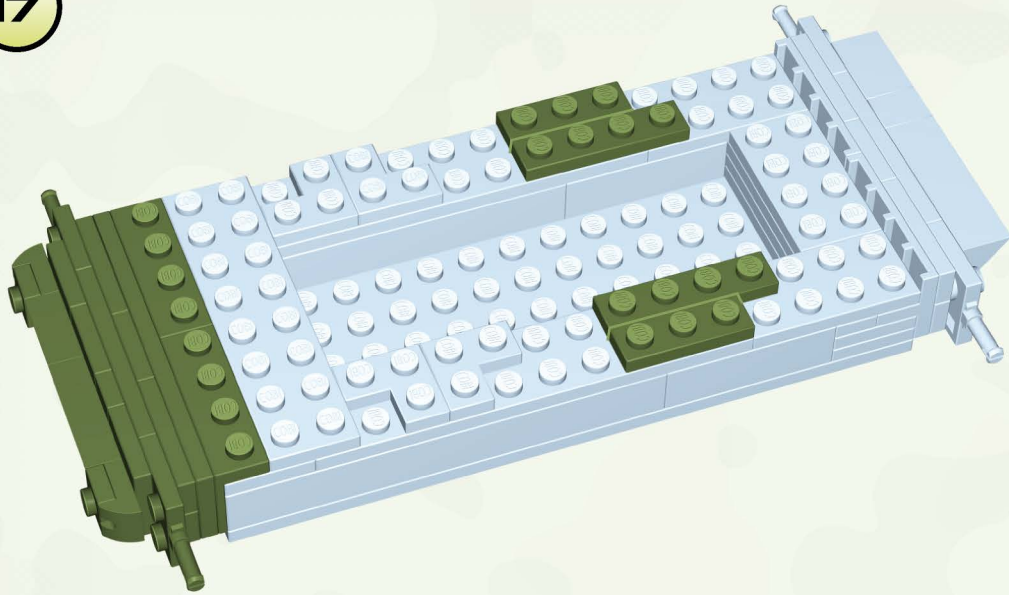

18

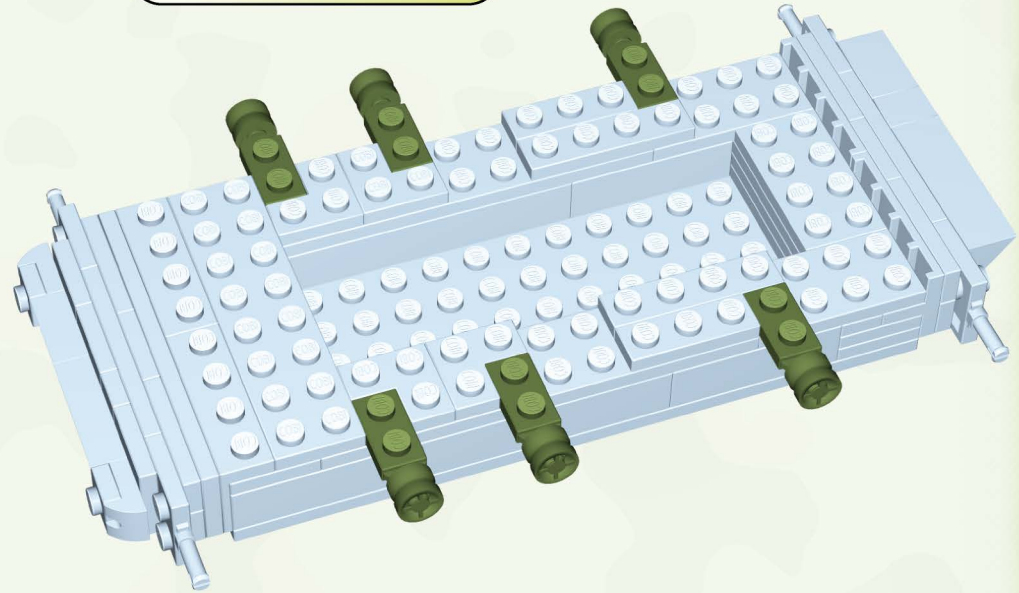
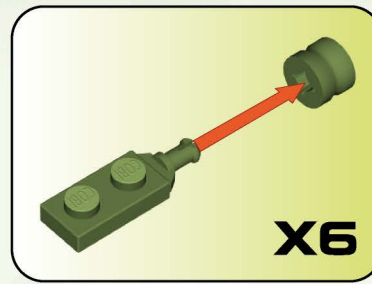

19

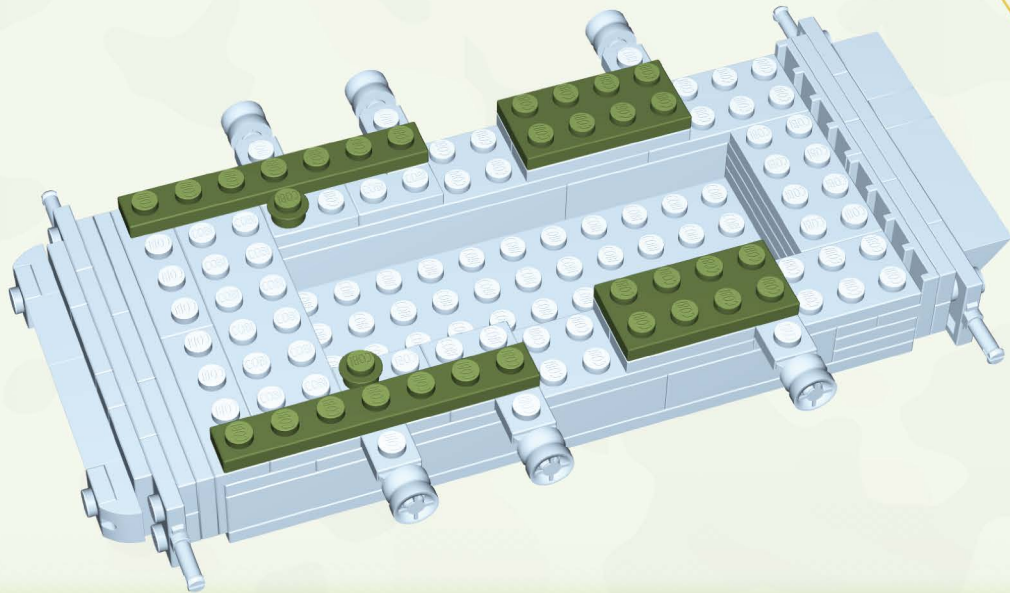

20

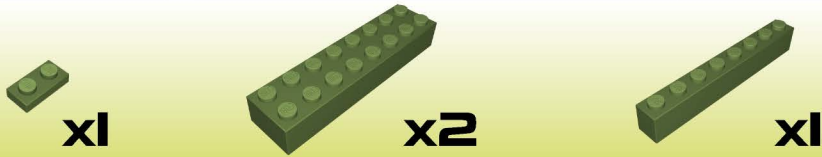
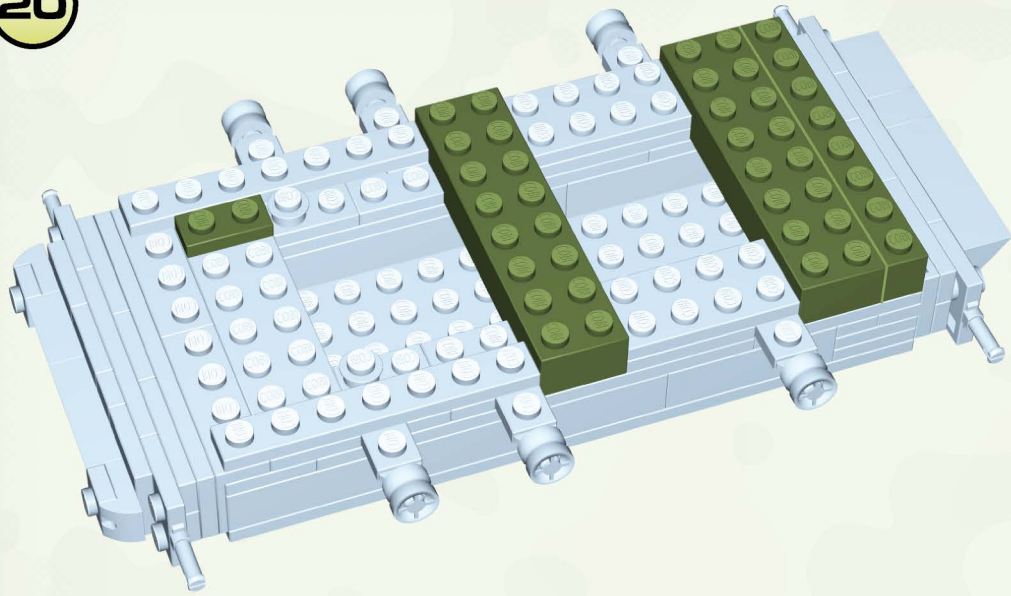

21

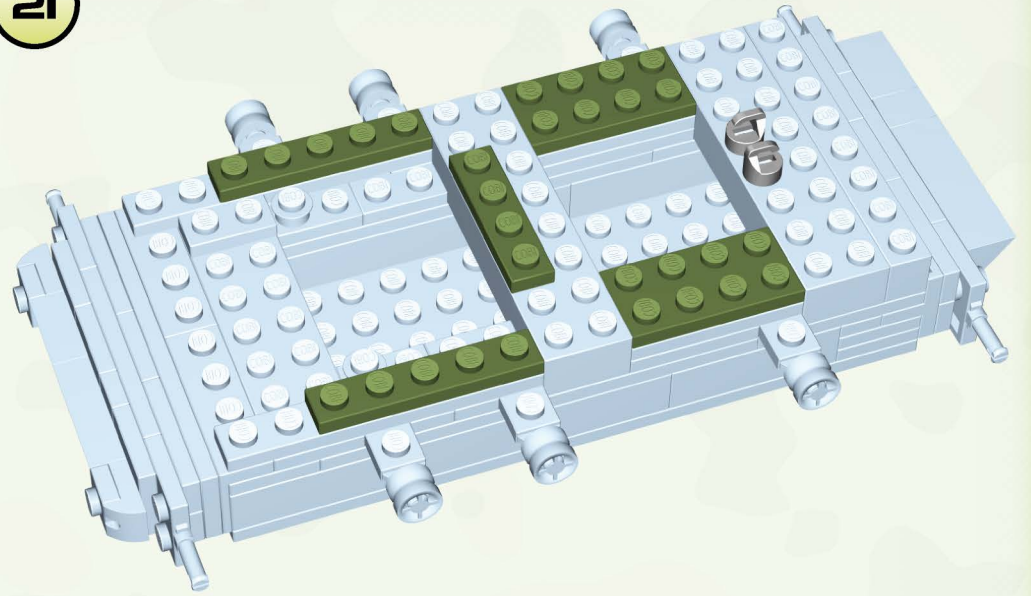

22

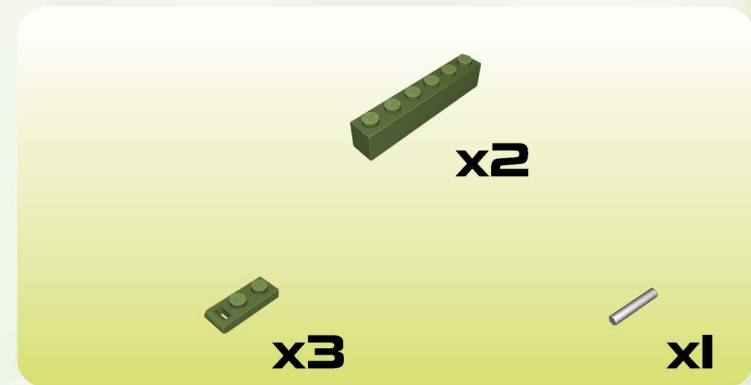
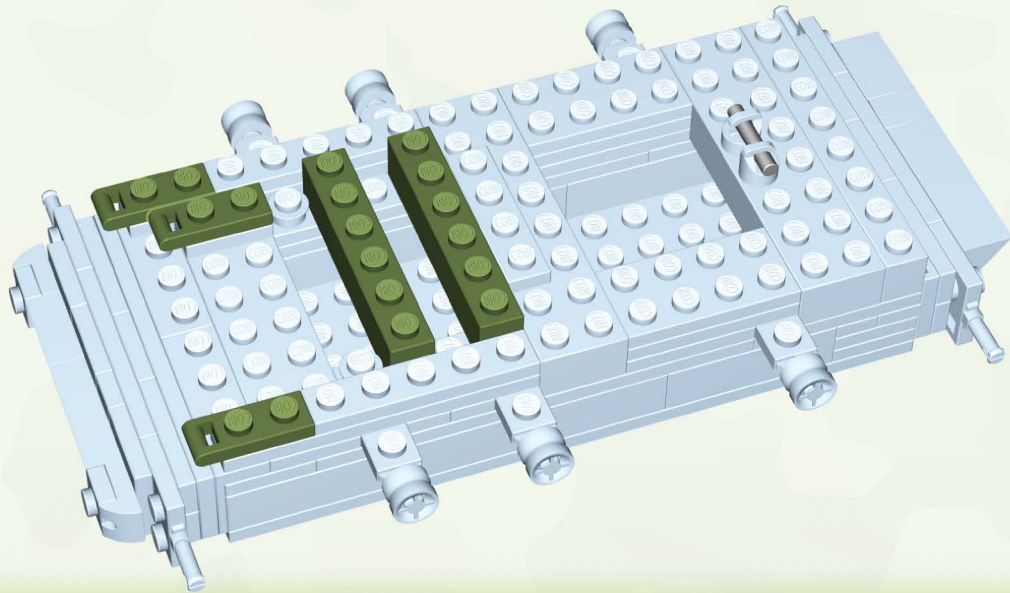

23

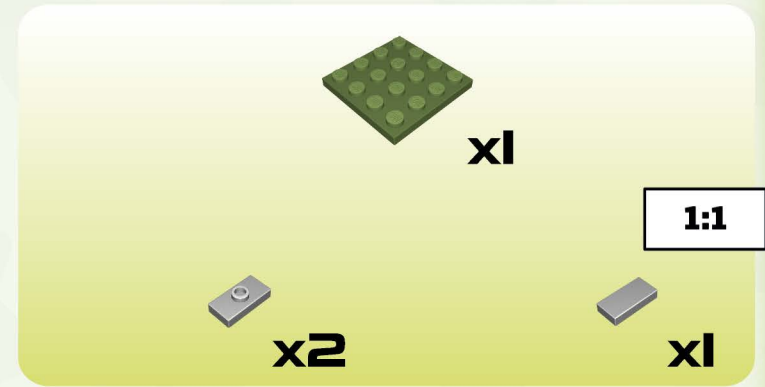
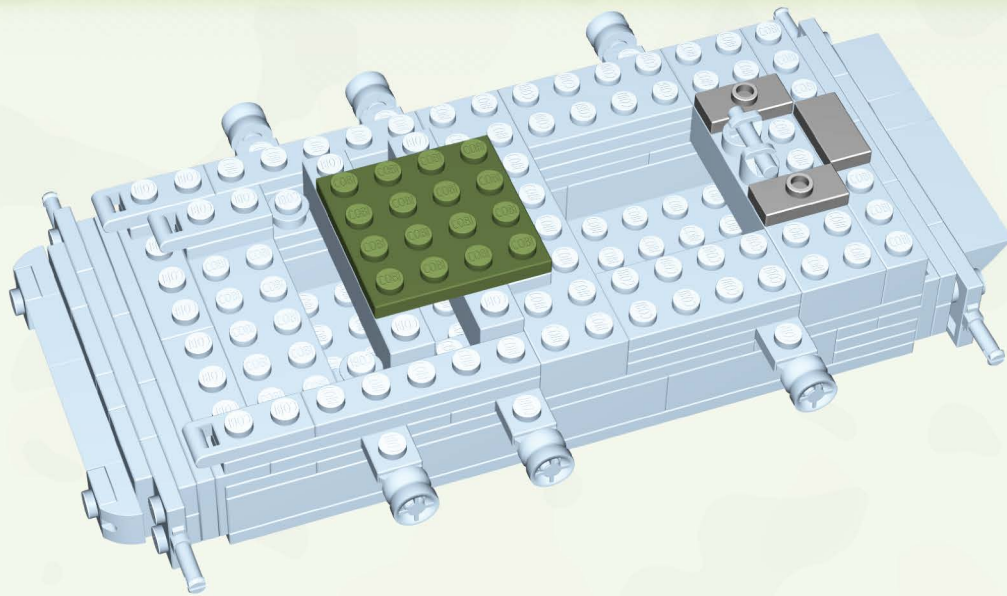

24

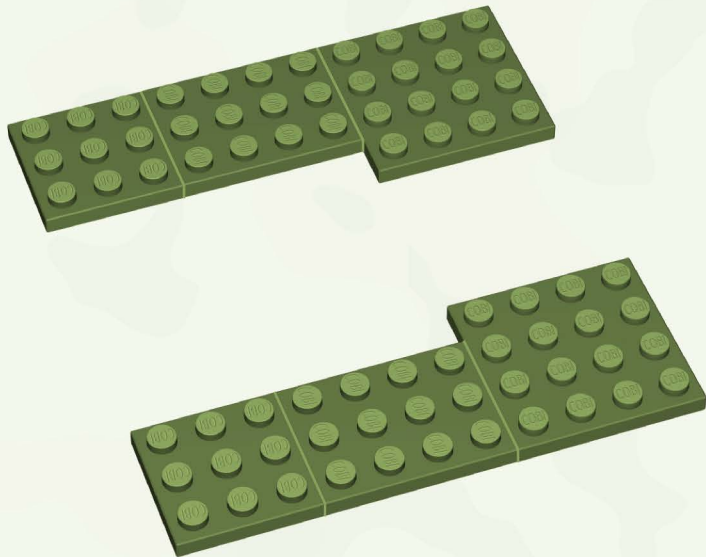

25

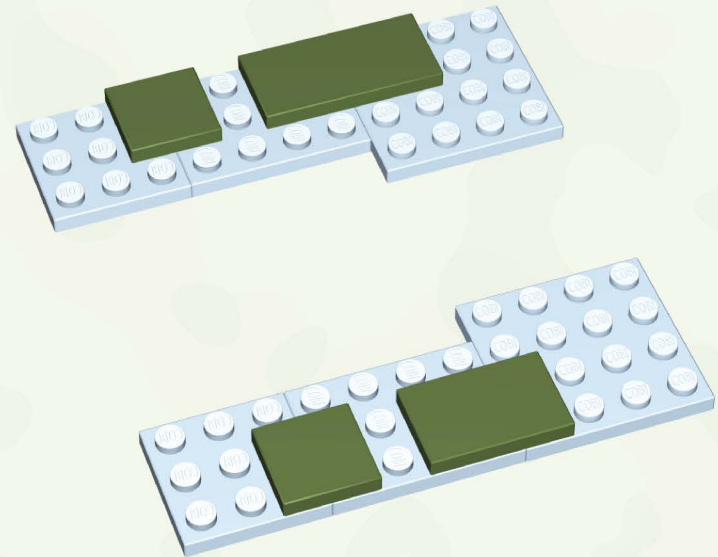

26

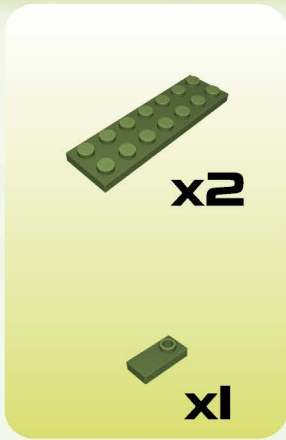
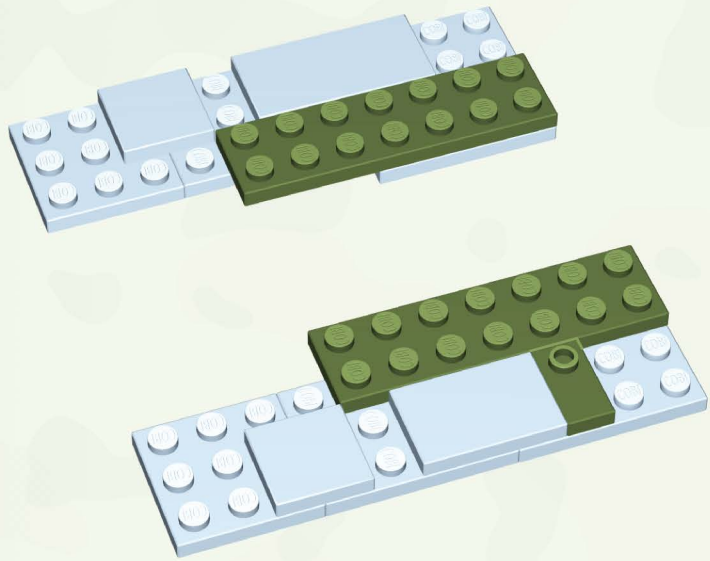

27

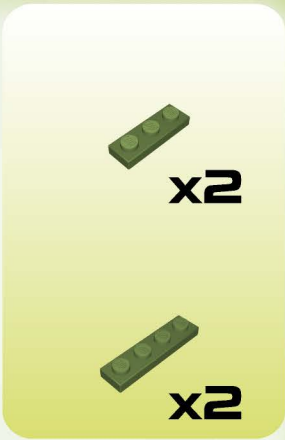
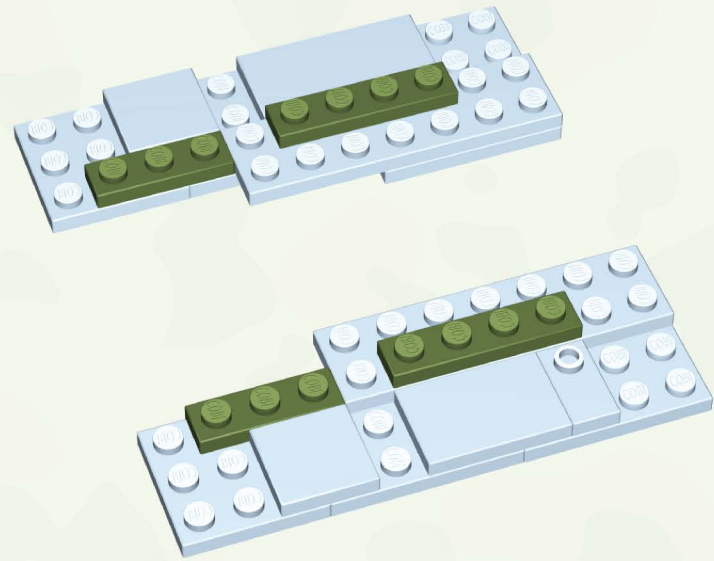

28

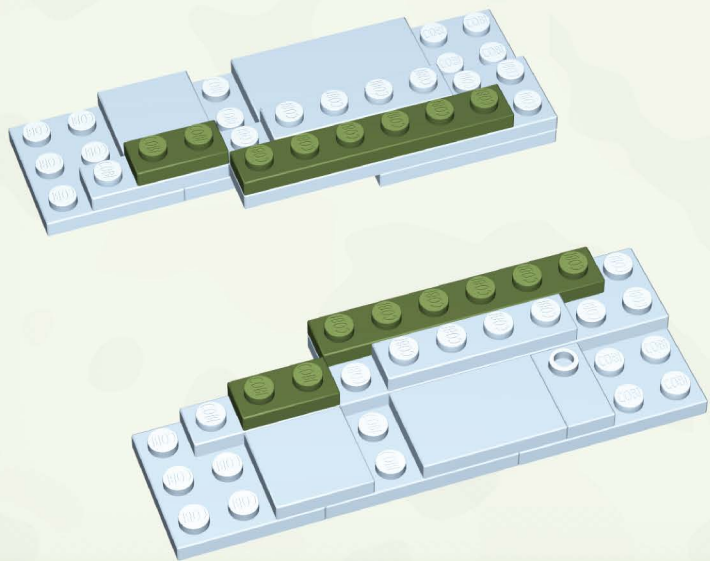

29

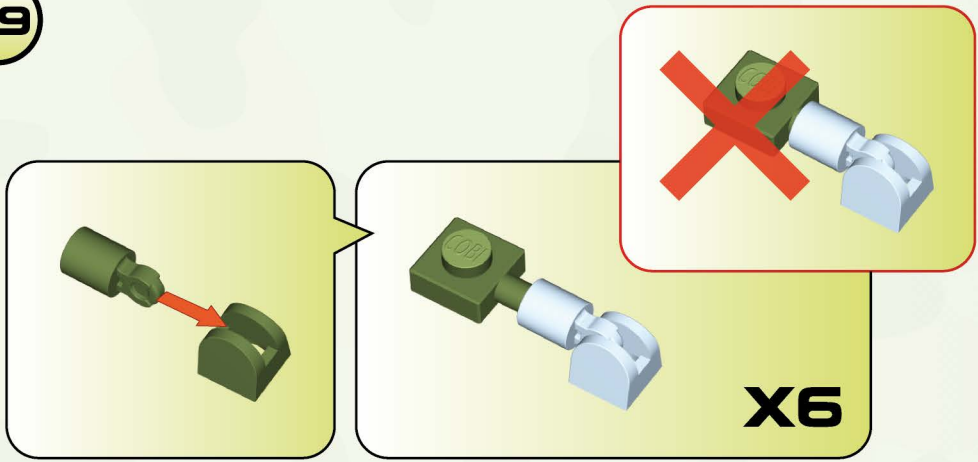

30

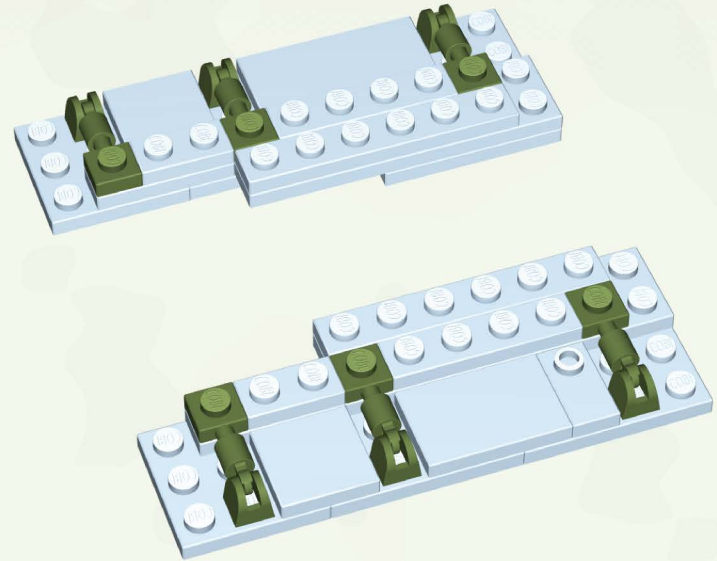
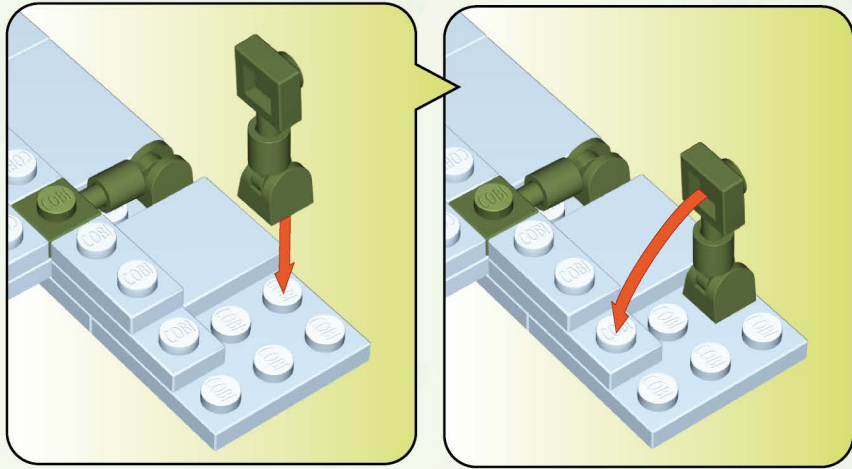

31

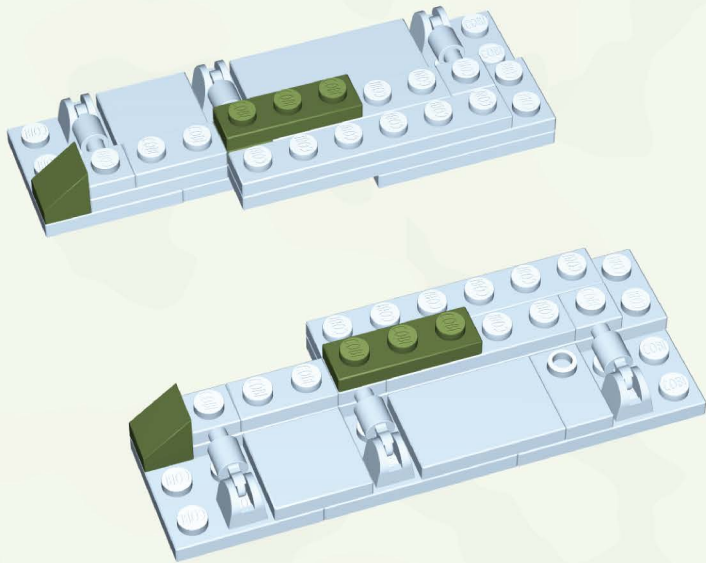

ⓑ



x2



x2

32

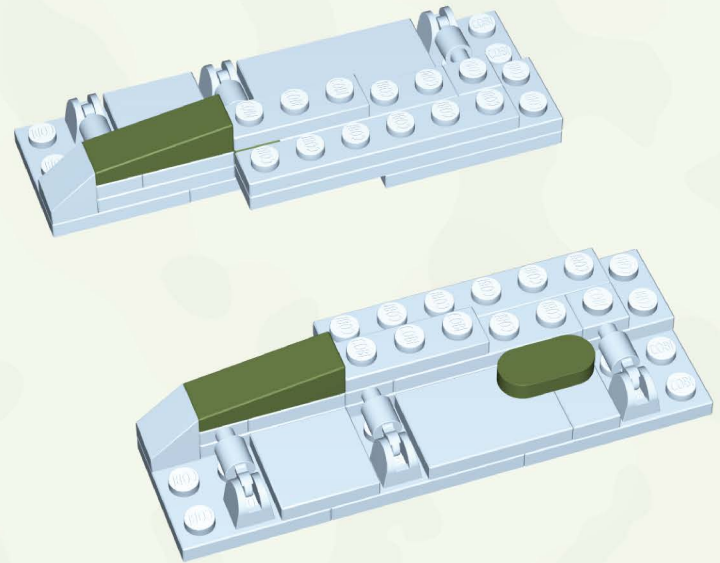

ⓒ



x2



x1

33

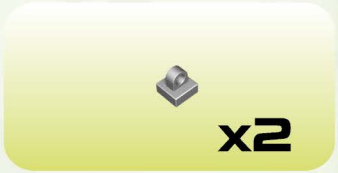
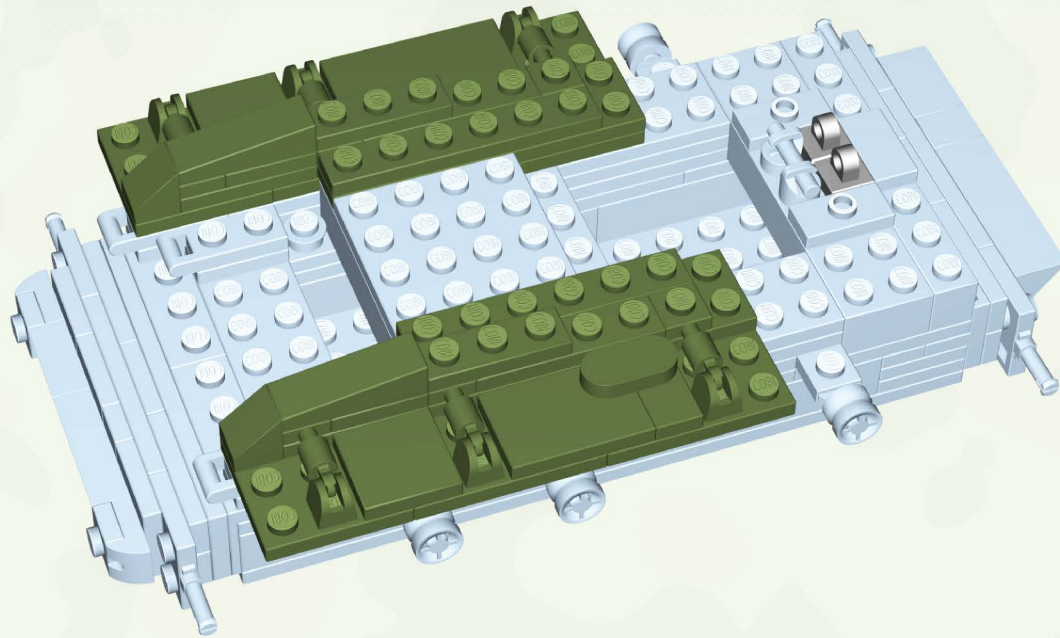

34

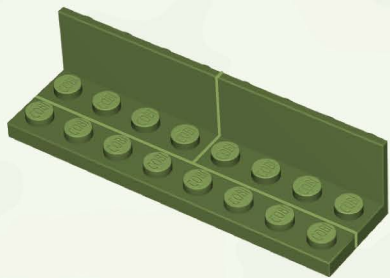

35

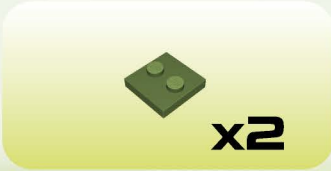
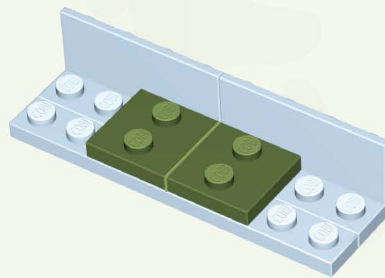

36

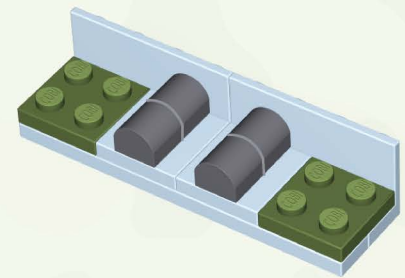

37

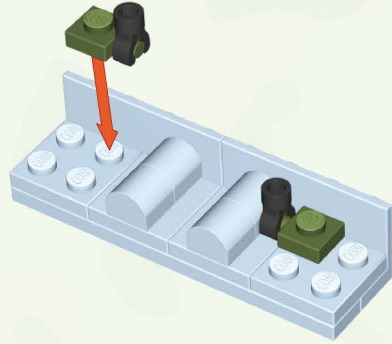
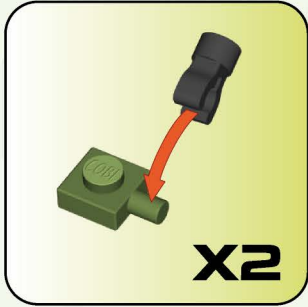

38

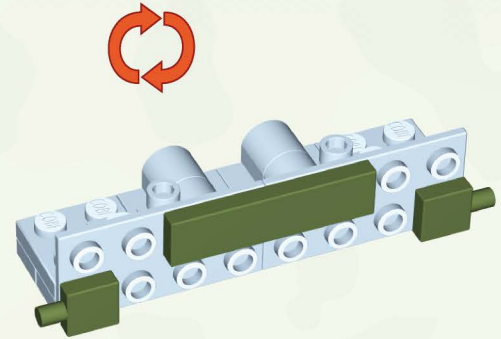

39

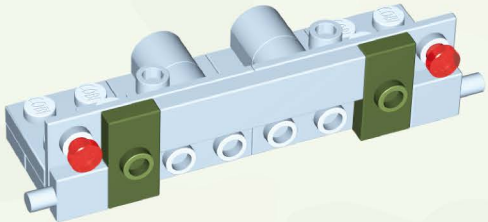

40

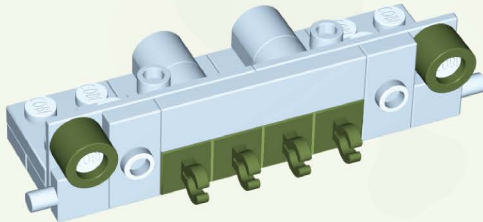

41

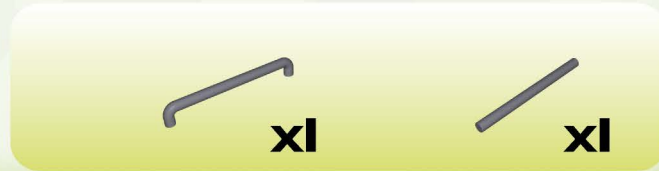
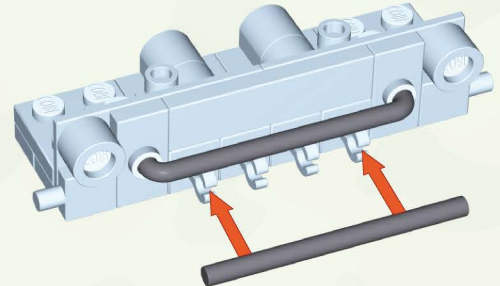

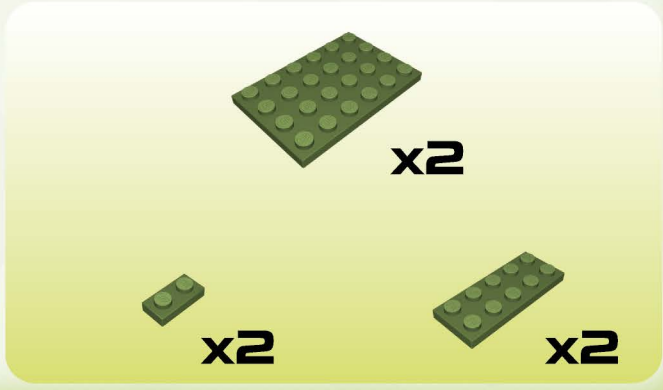
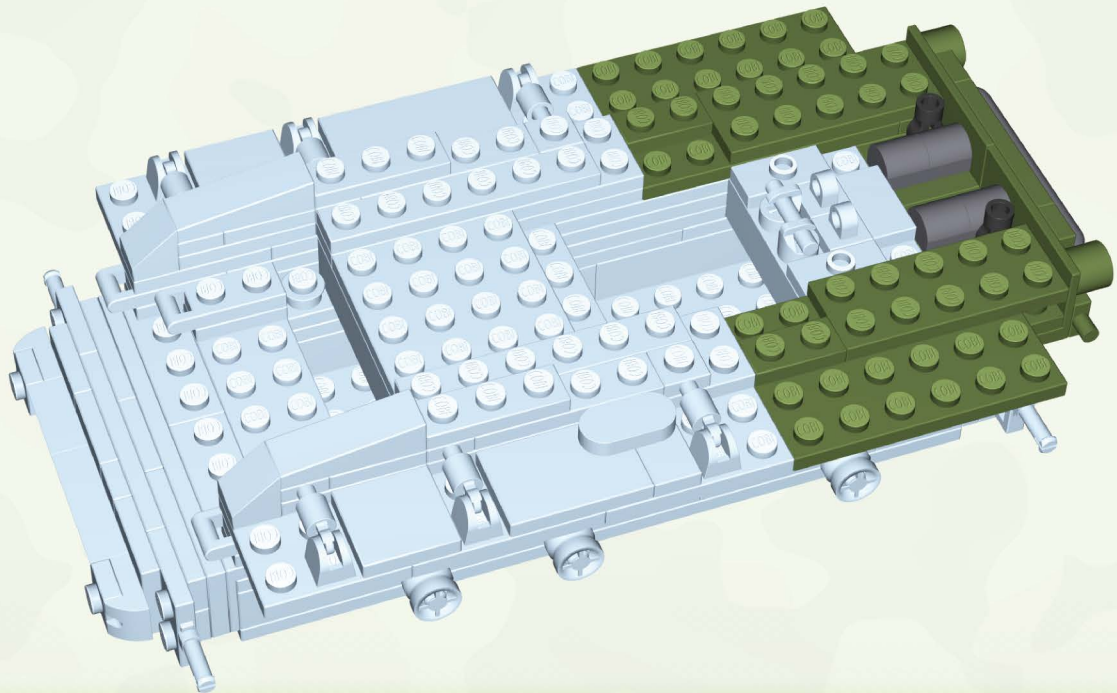
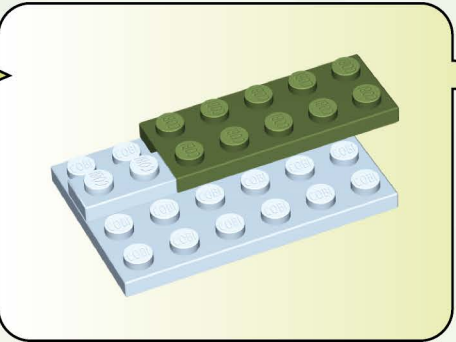
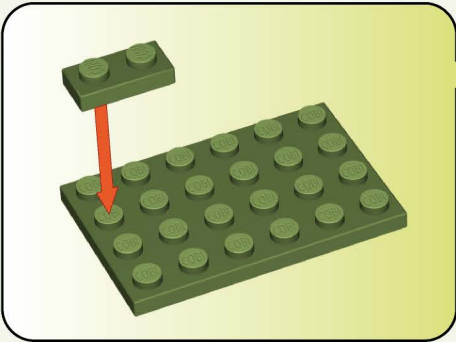
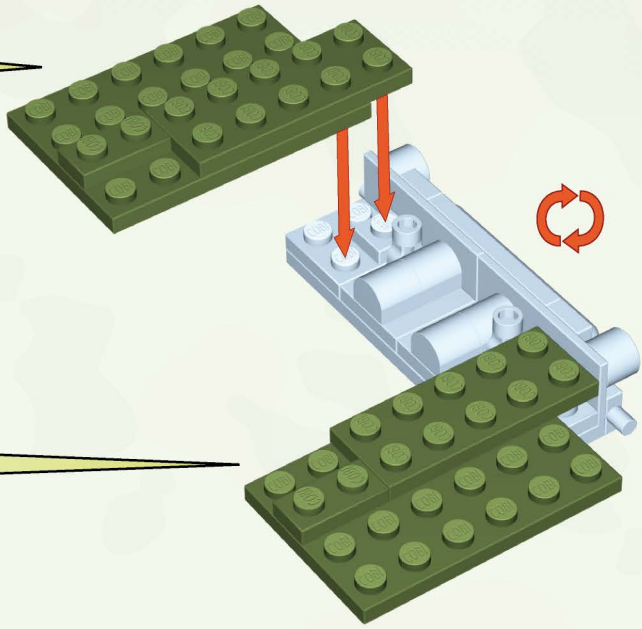
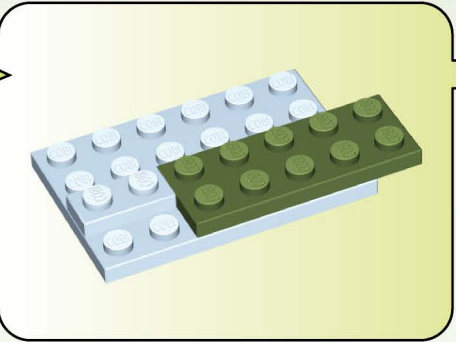
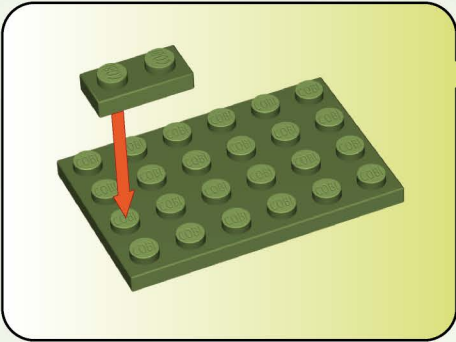

43

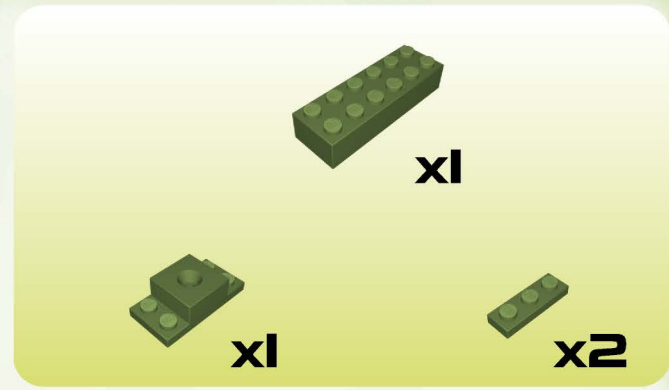
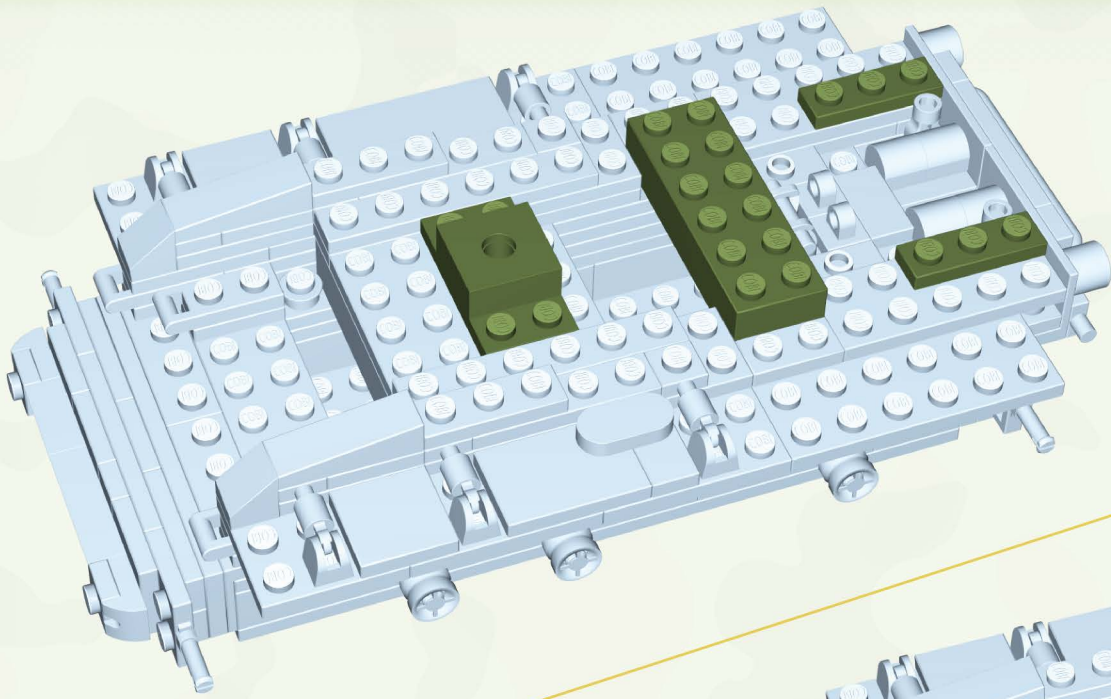

44

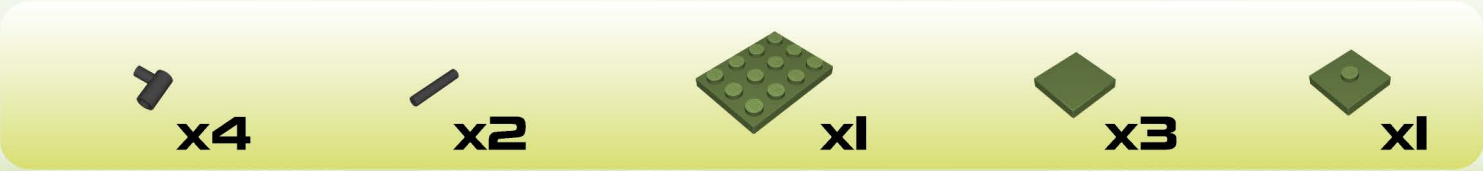
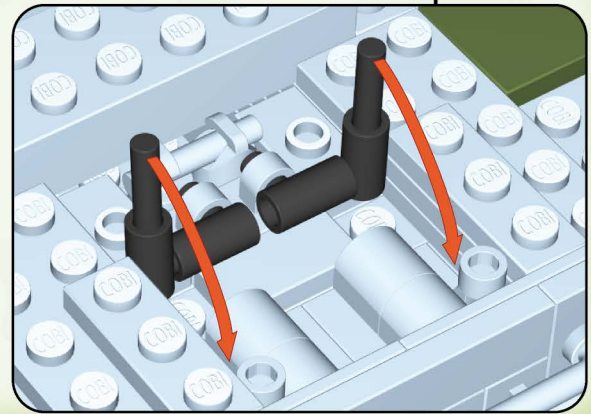
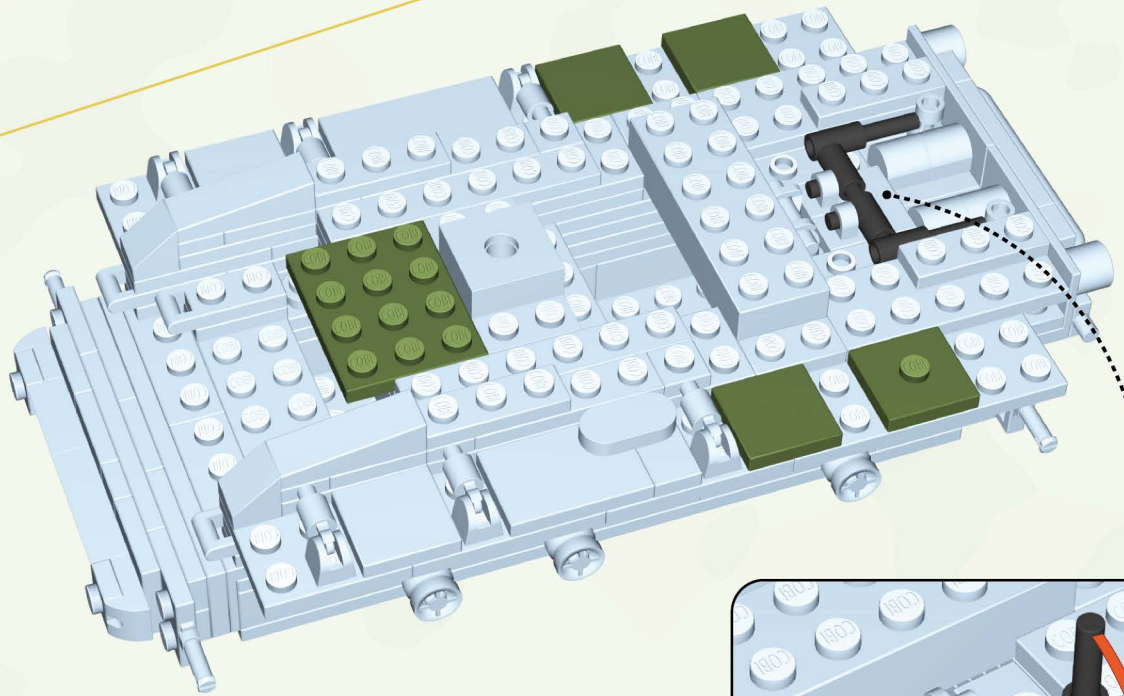
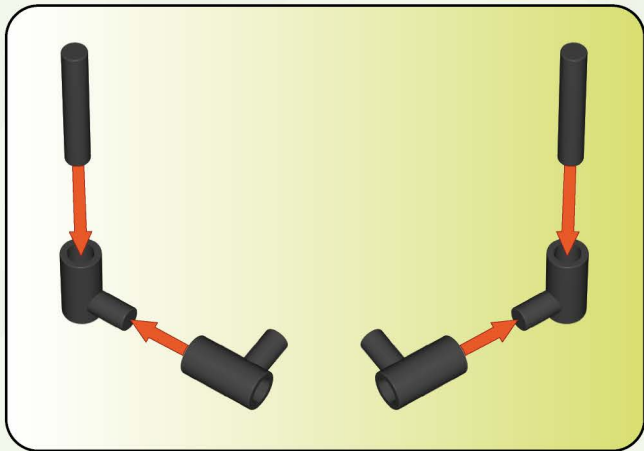

45

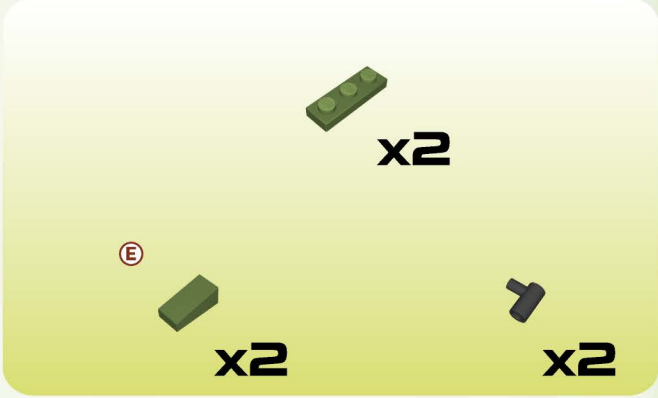
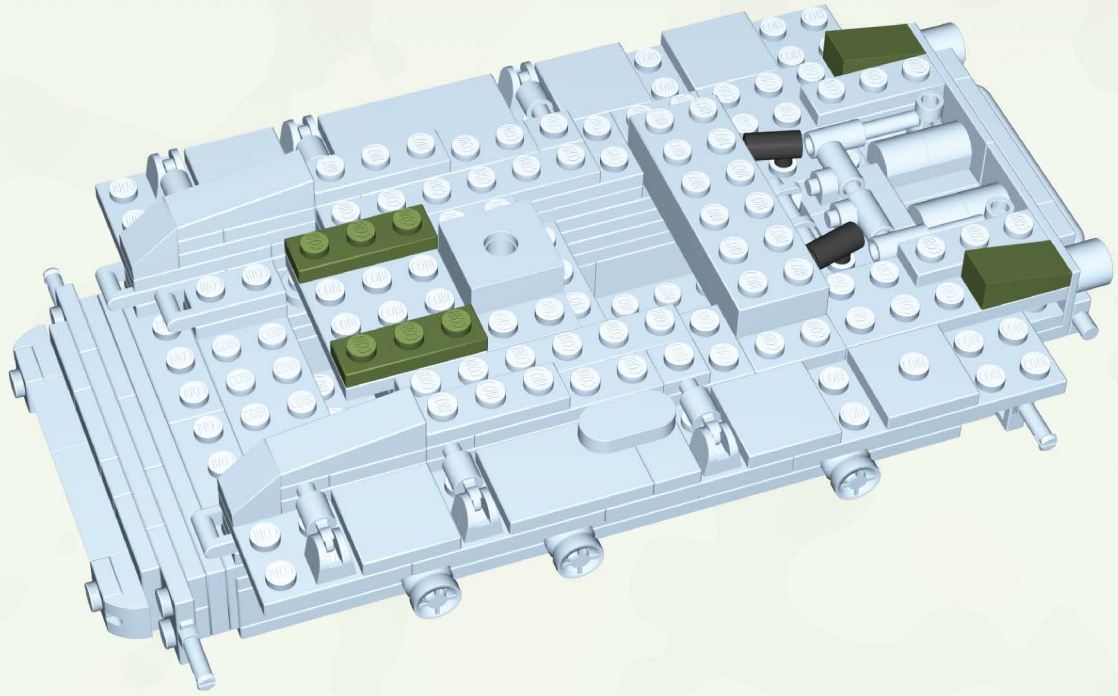

46

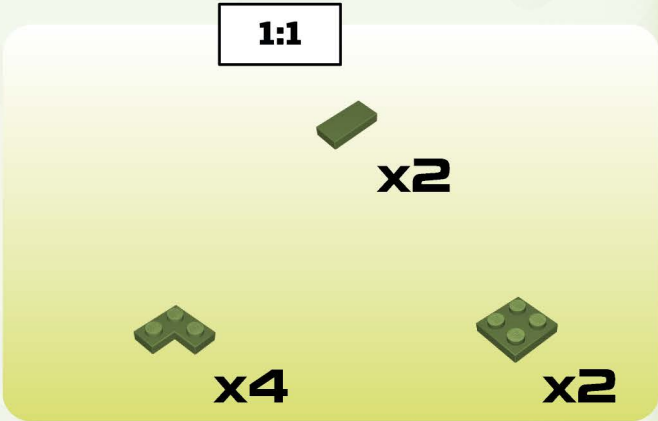
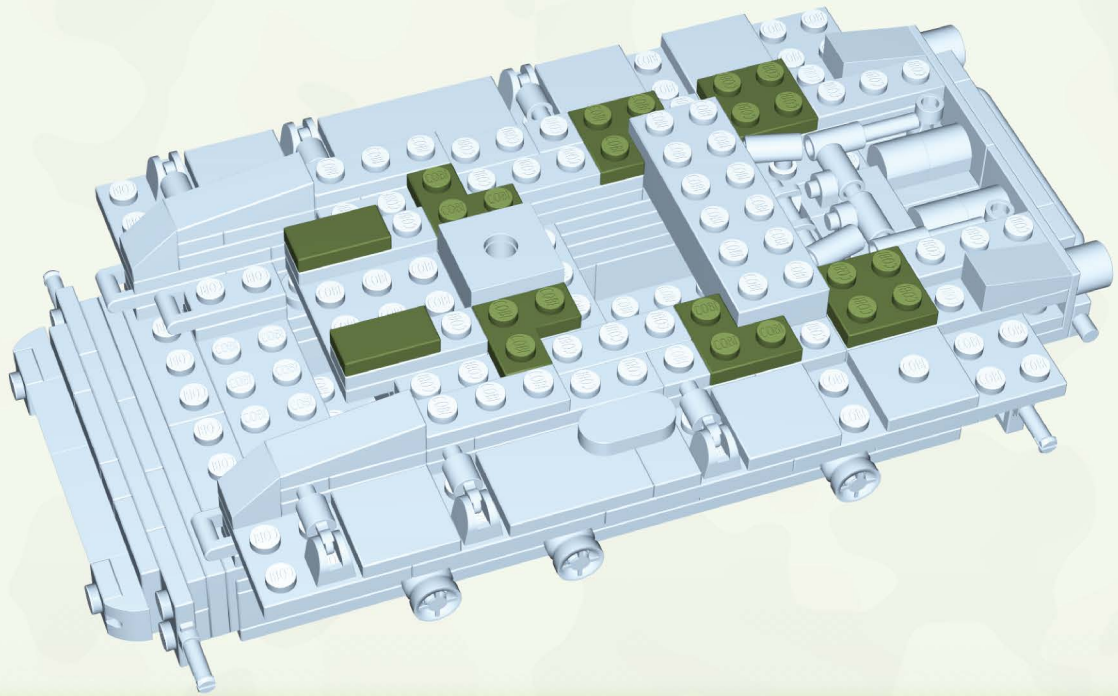

47

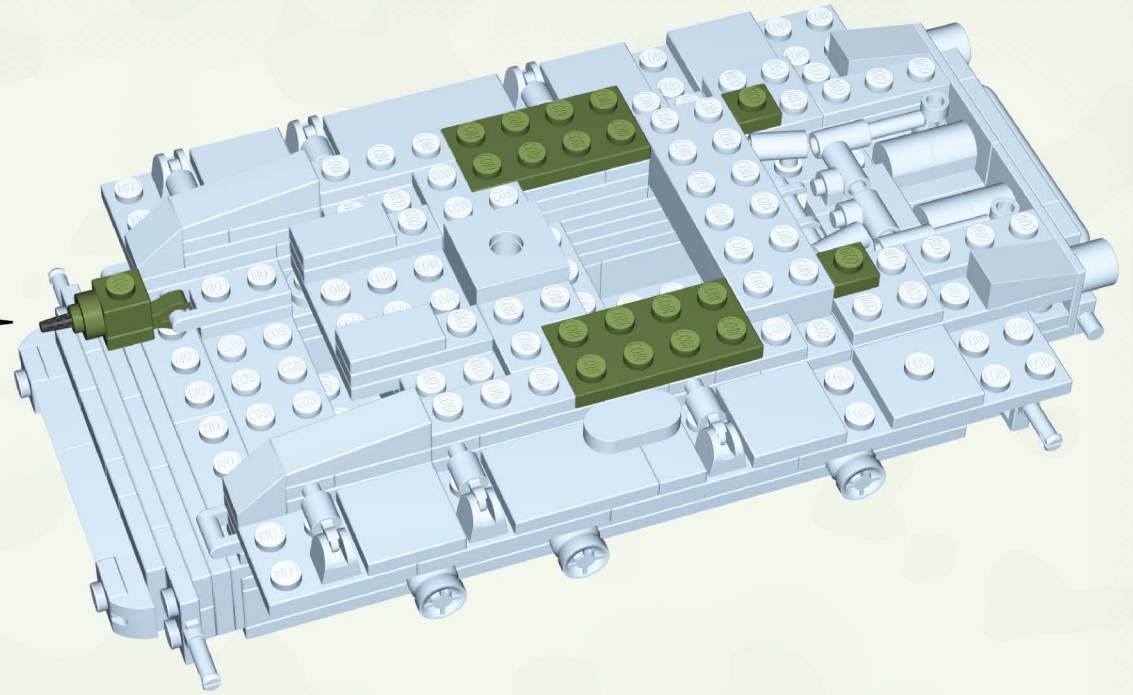
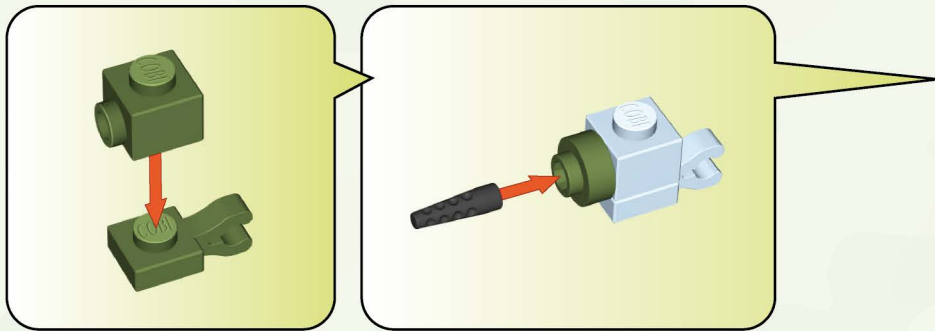

48

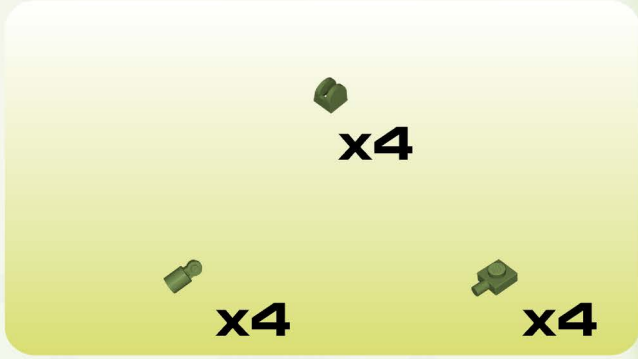
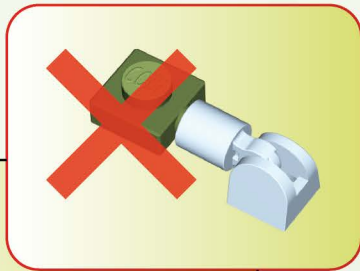
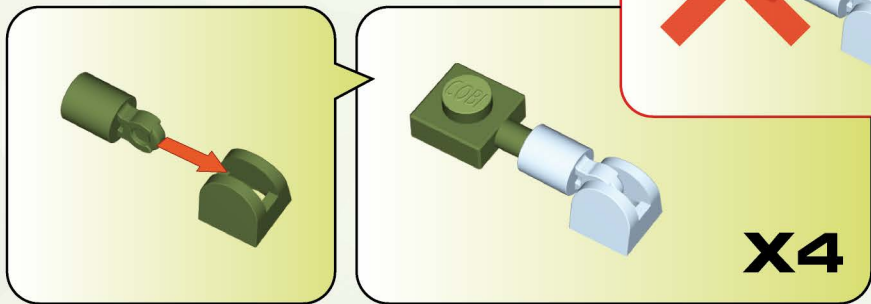

49

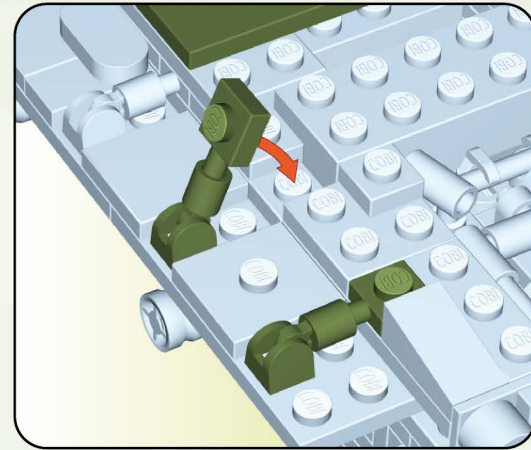
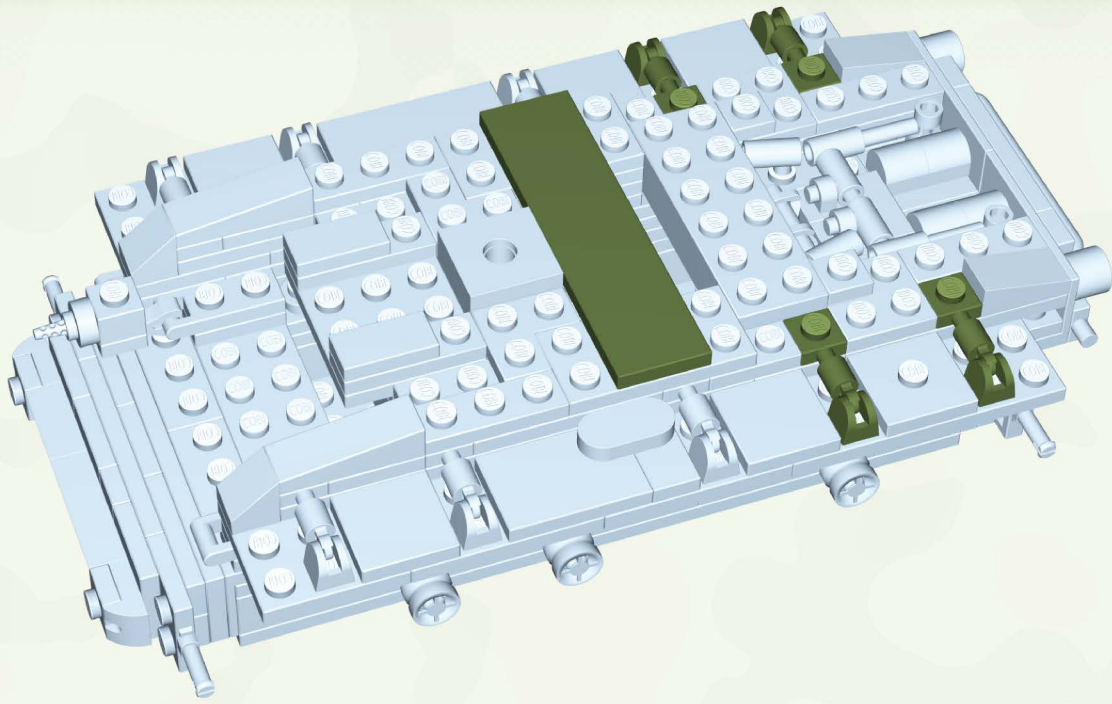

50

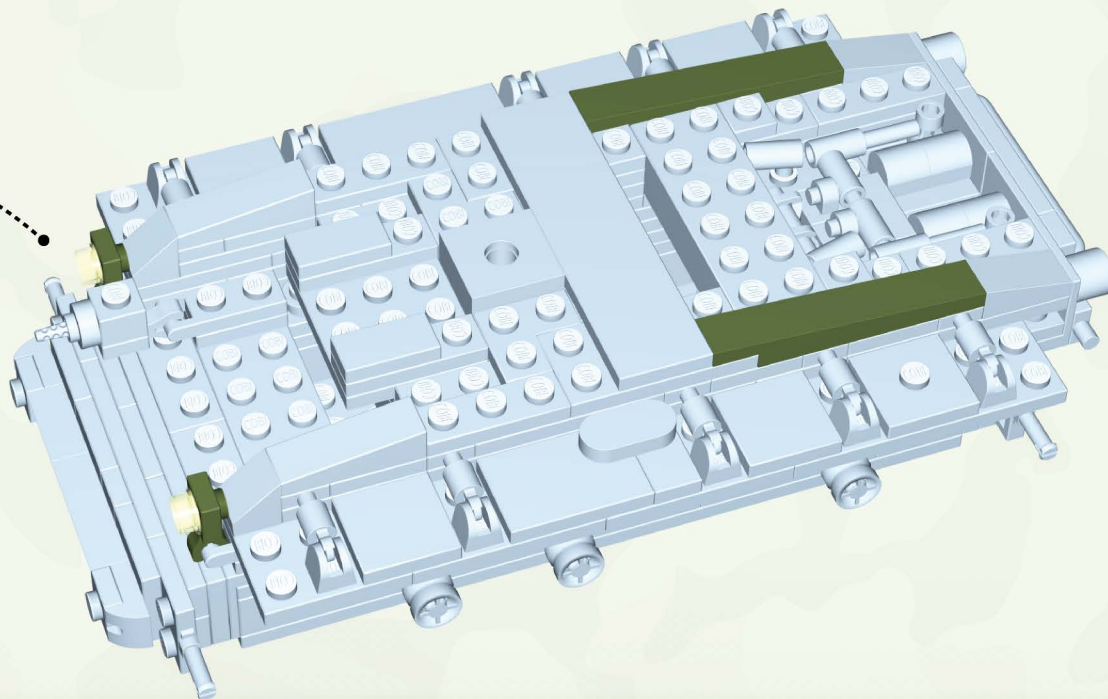
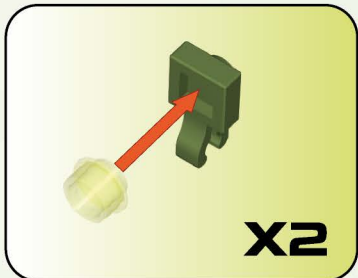
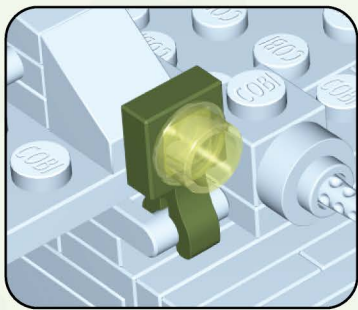

53

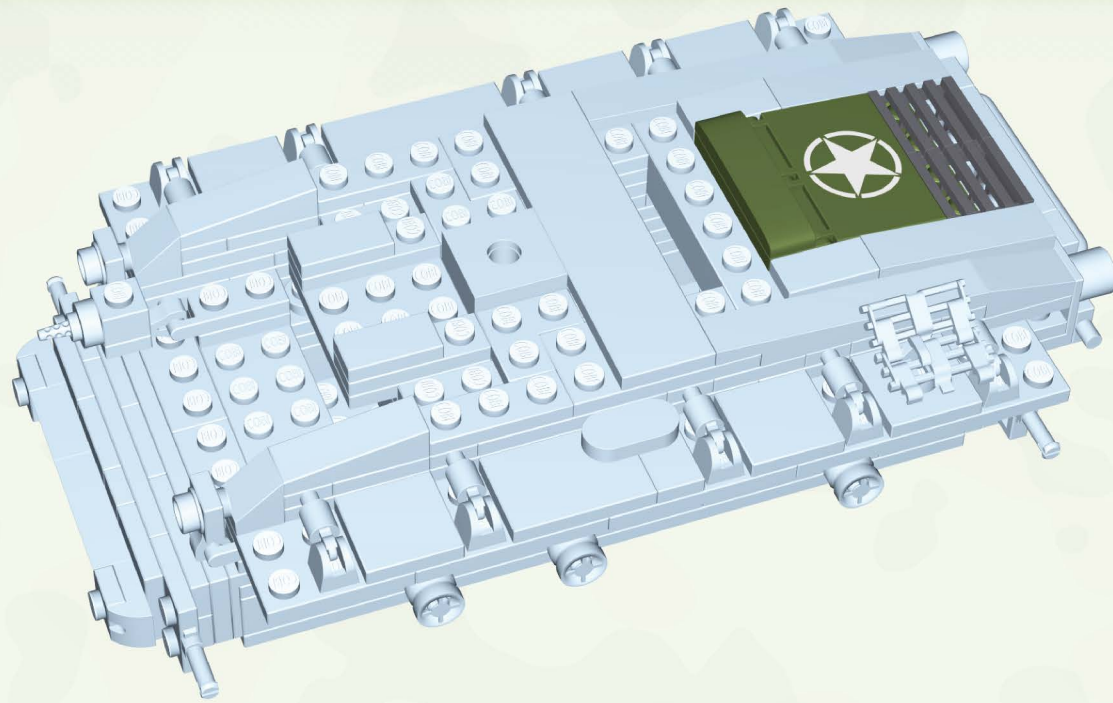

54

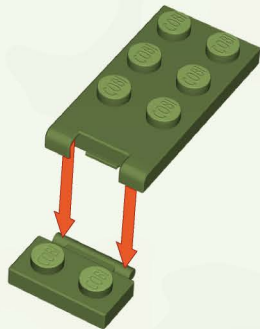

x1

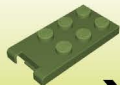

x1

55

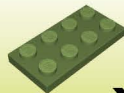
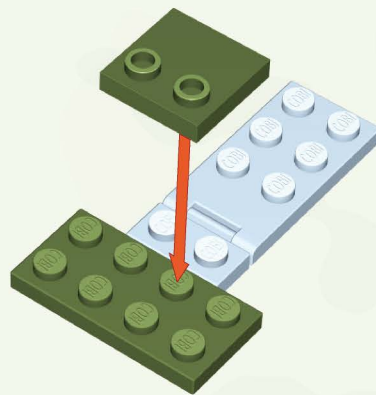

x1



x1

56

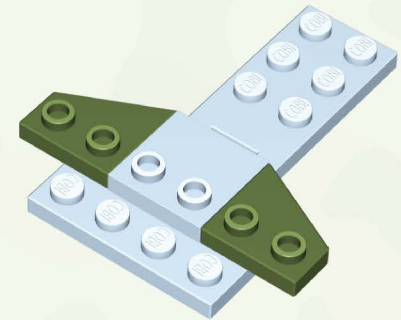

x1



x1

57

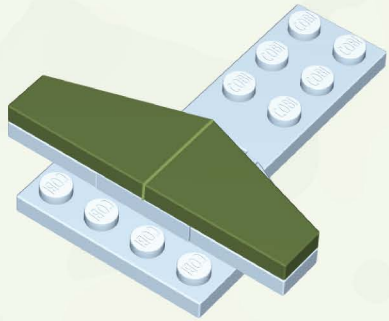

x1



x1

58

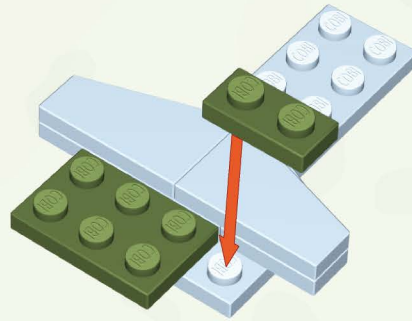

x1



x1

59

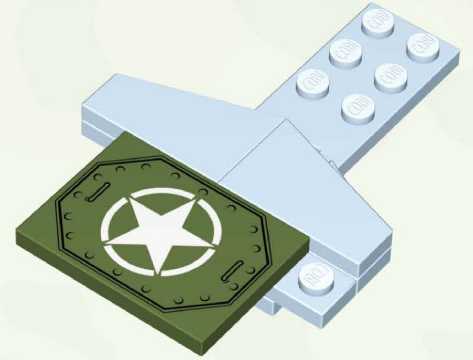

x1

60

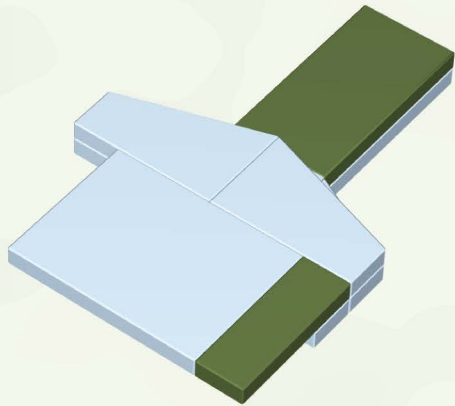

1:1

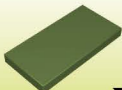

x1



x1

61

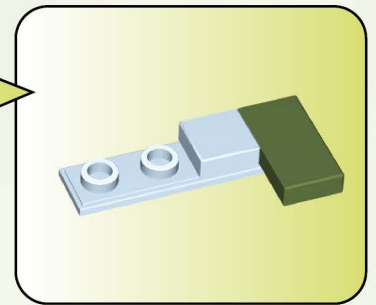
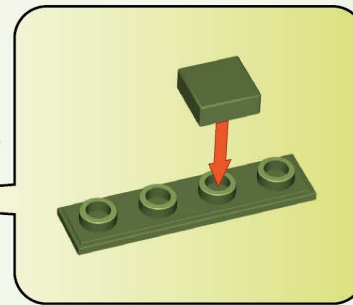
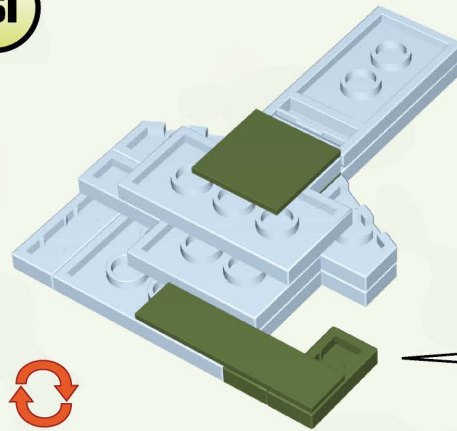

1:1



x1



x1



x1



x1

62

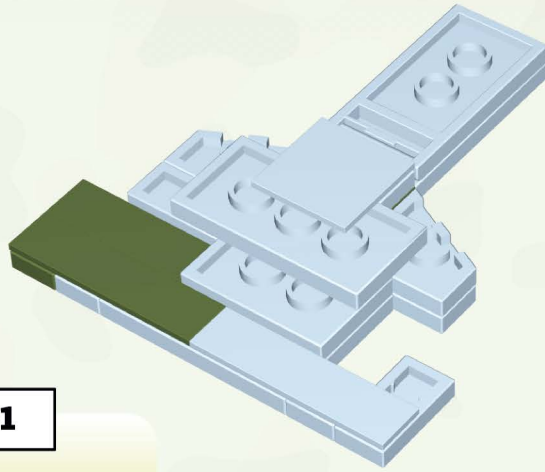
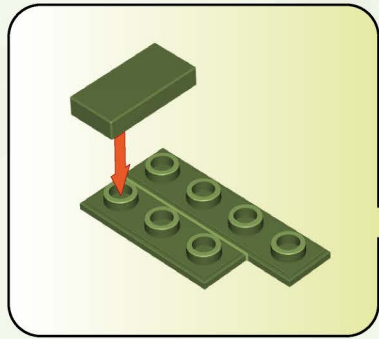

1:1



x1



x1



x1

63

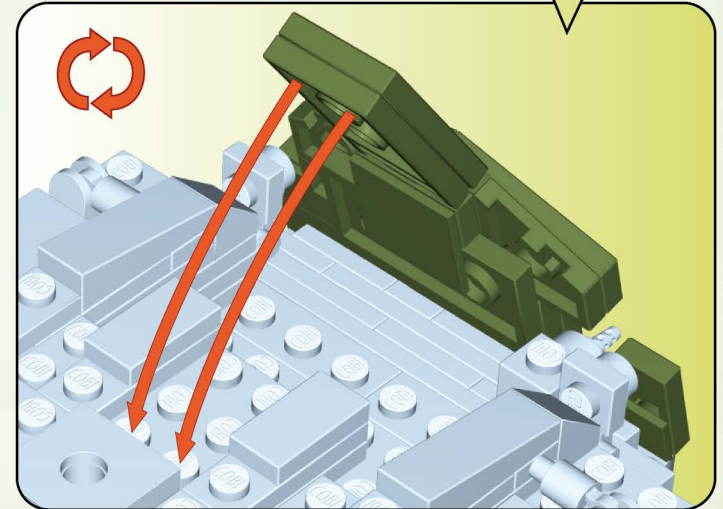
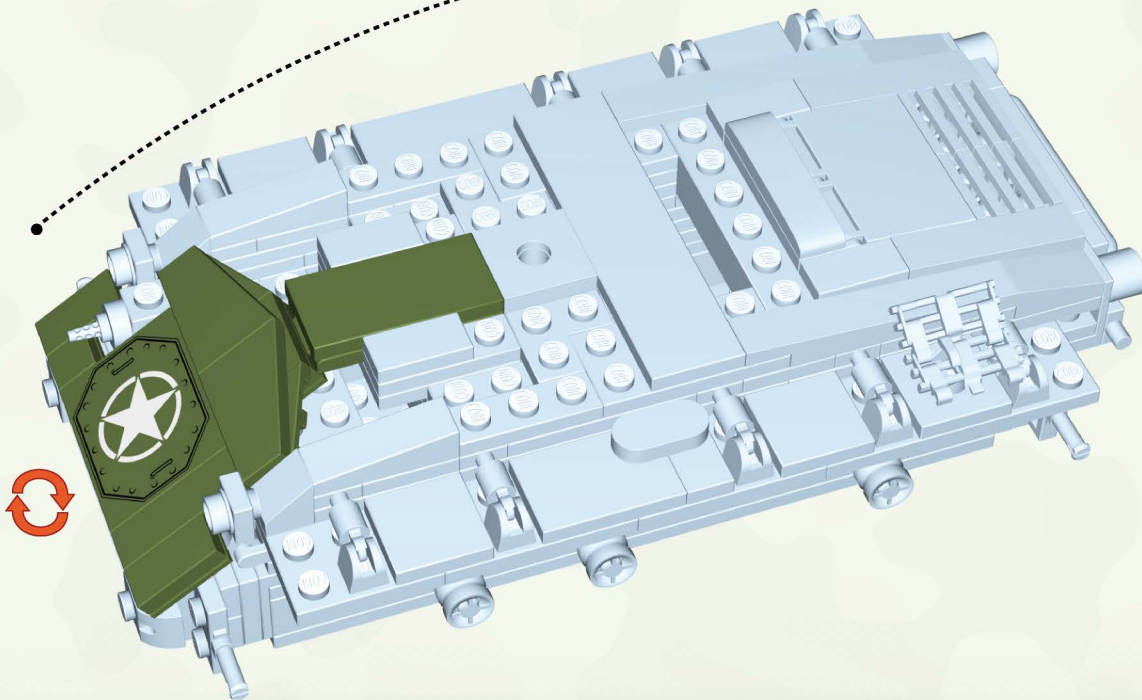
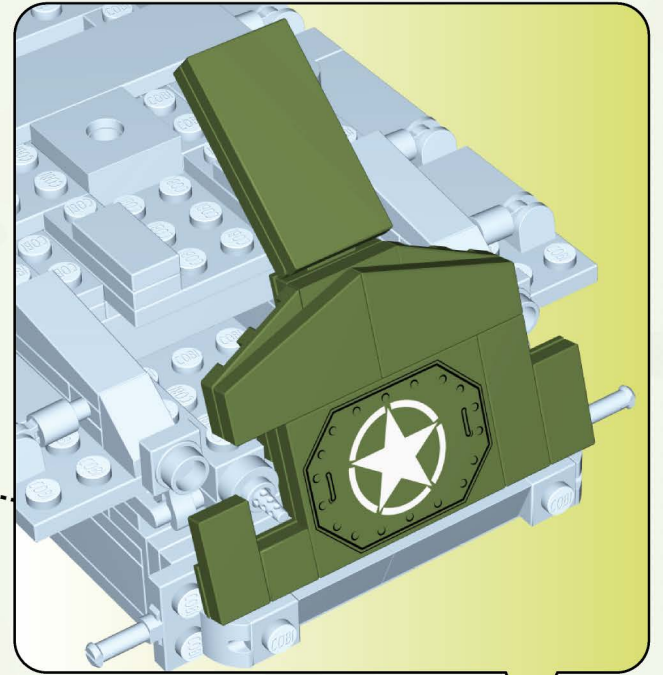

64

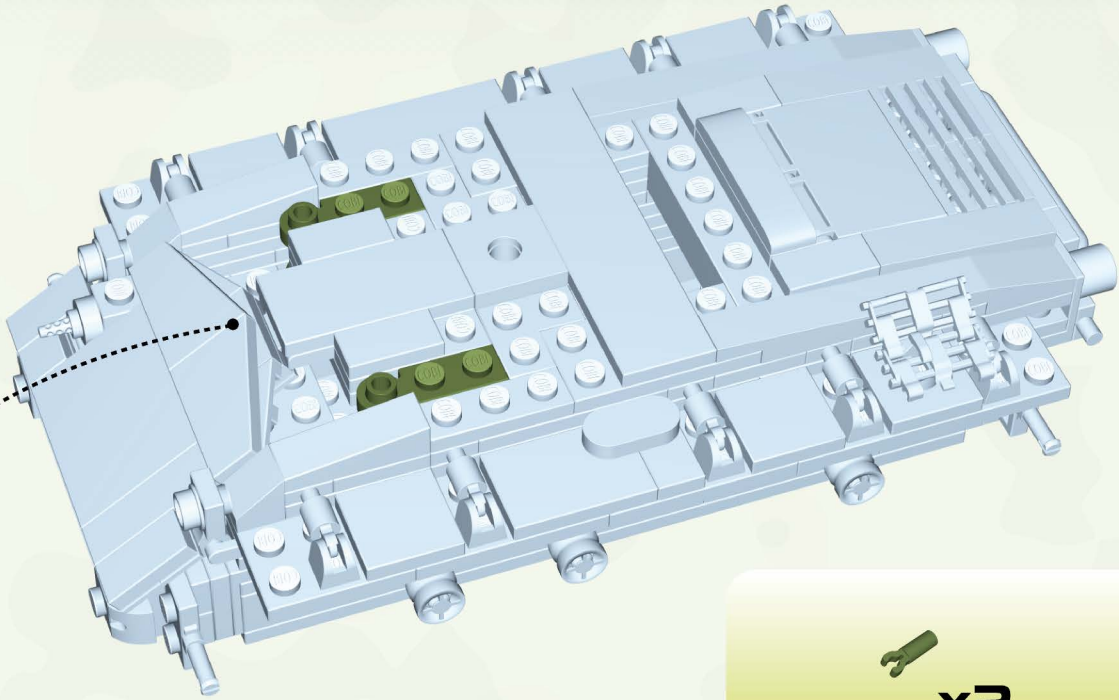
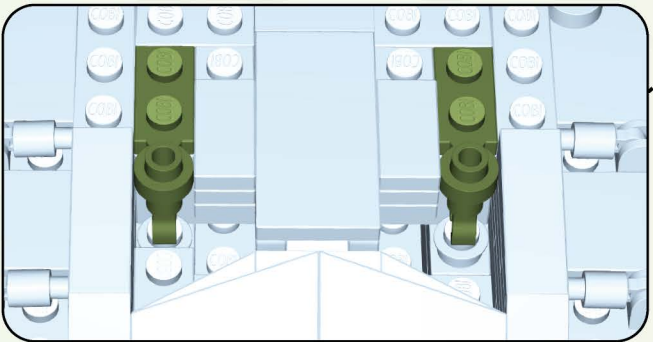
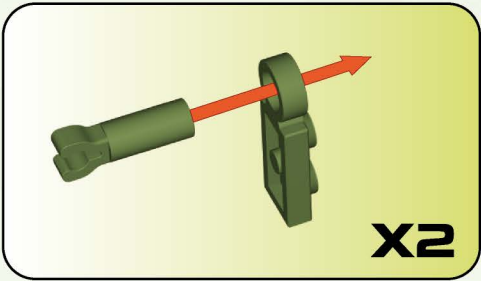

65

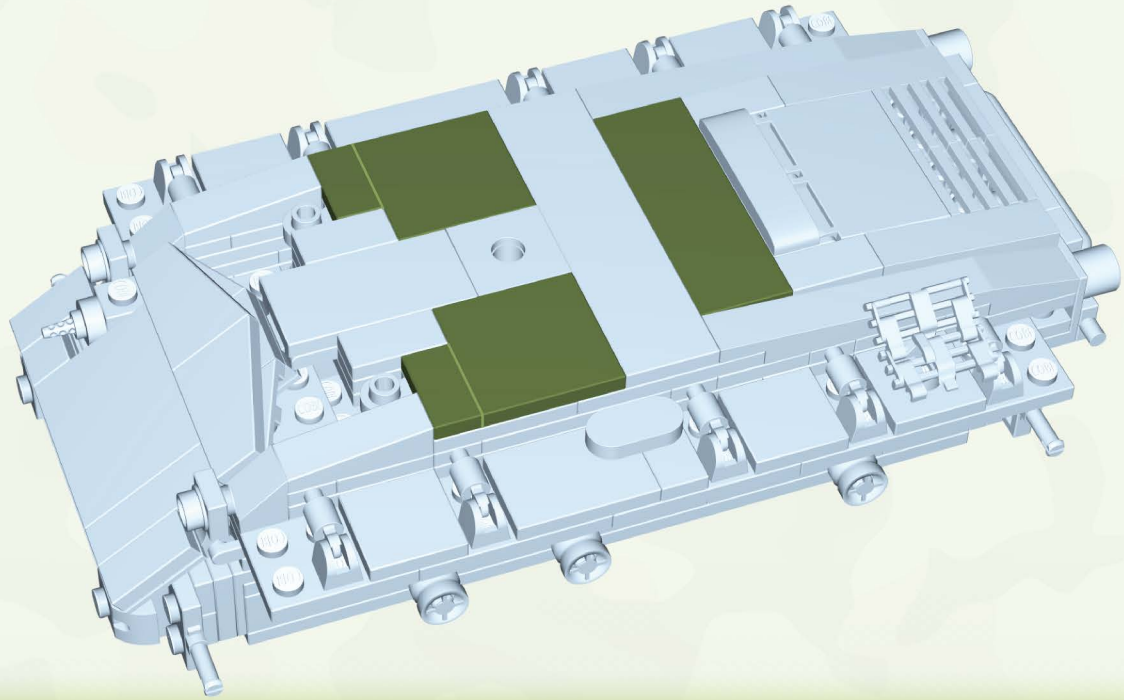

1:1



66

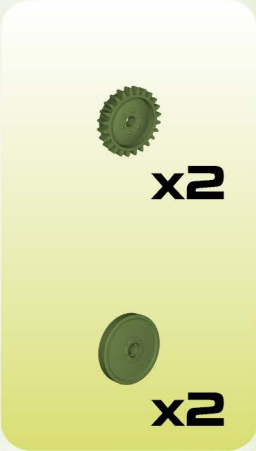
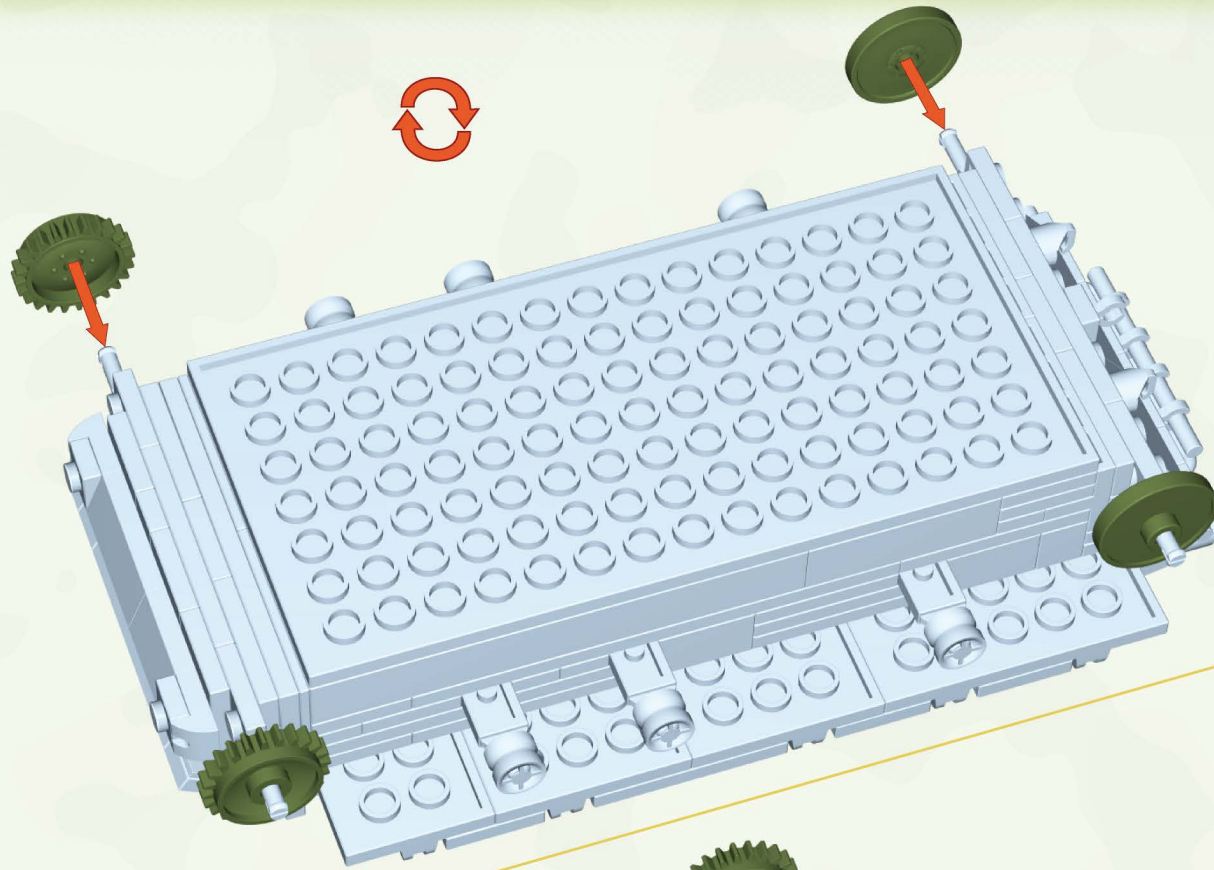

67

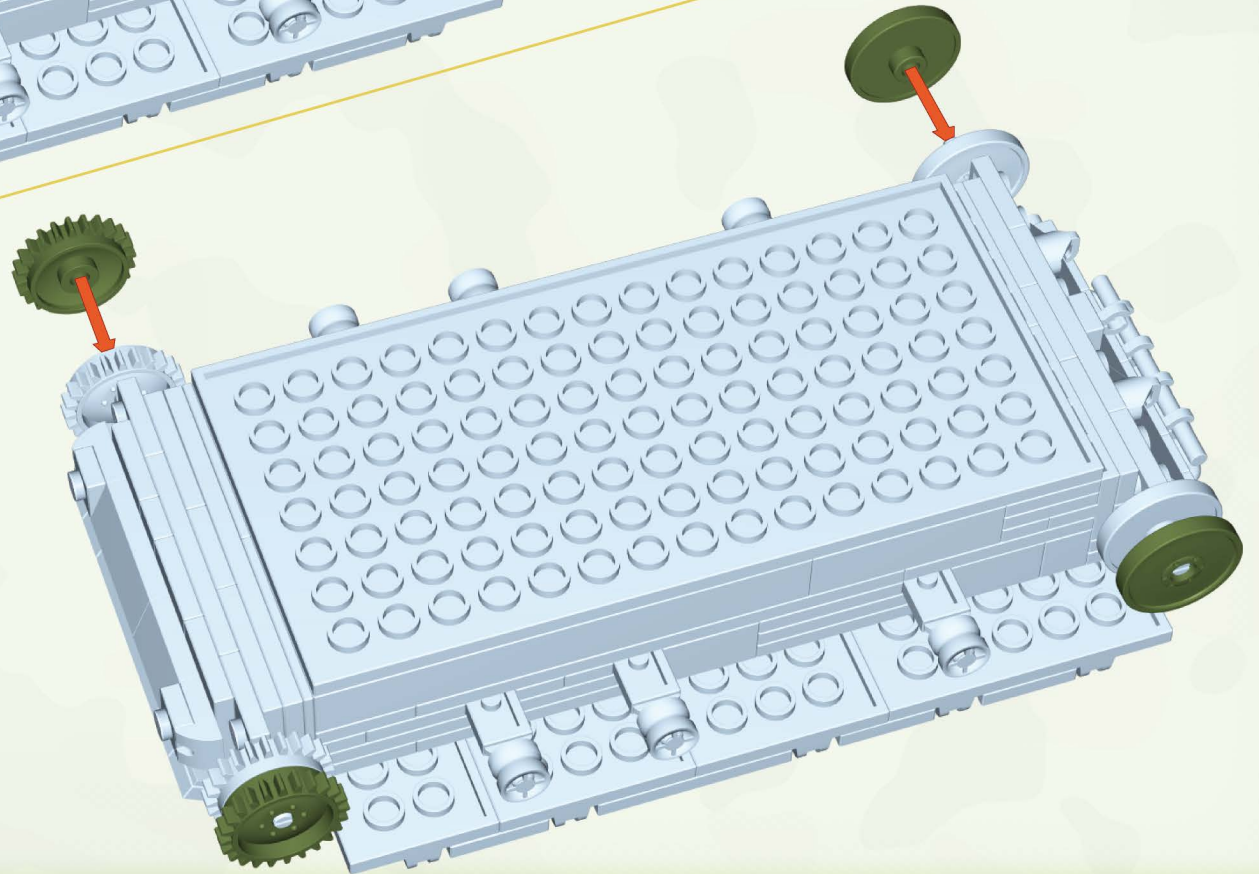
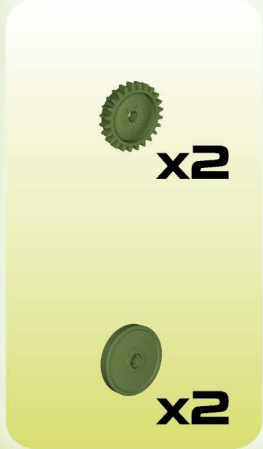

68 = 70



X10

69



68

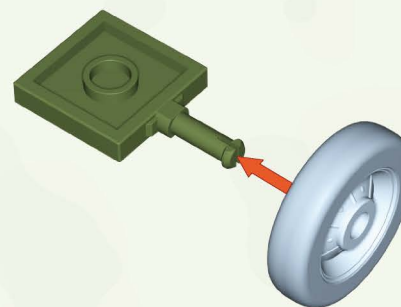
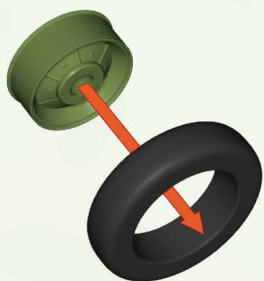

70

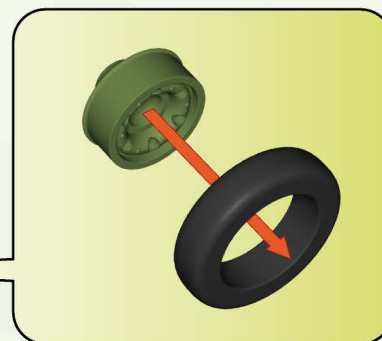
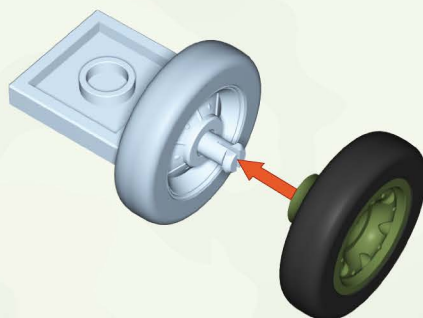

71

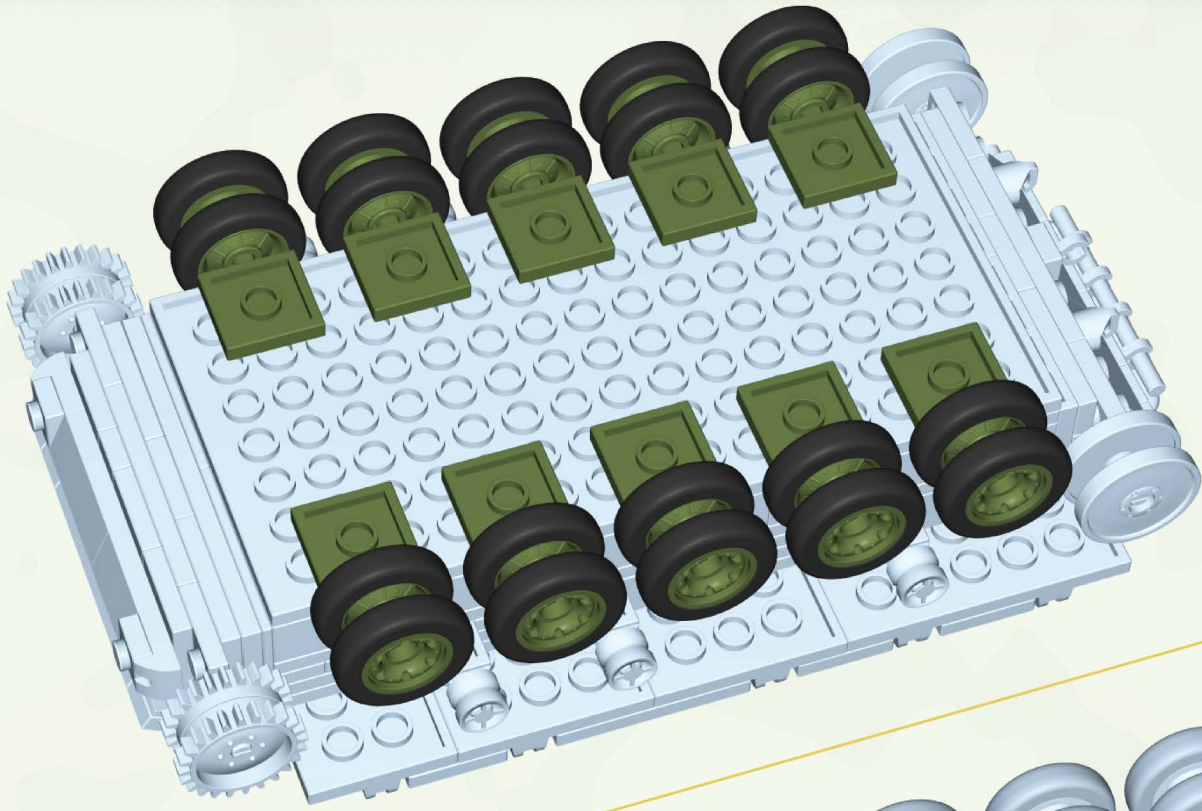

72

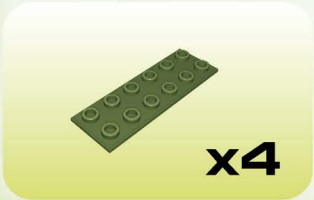
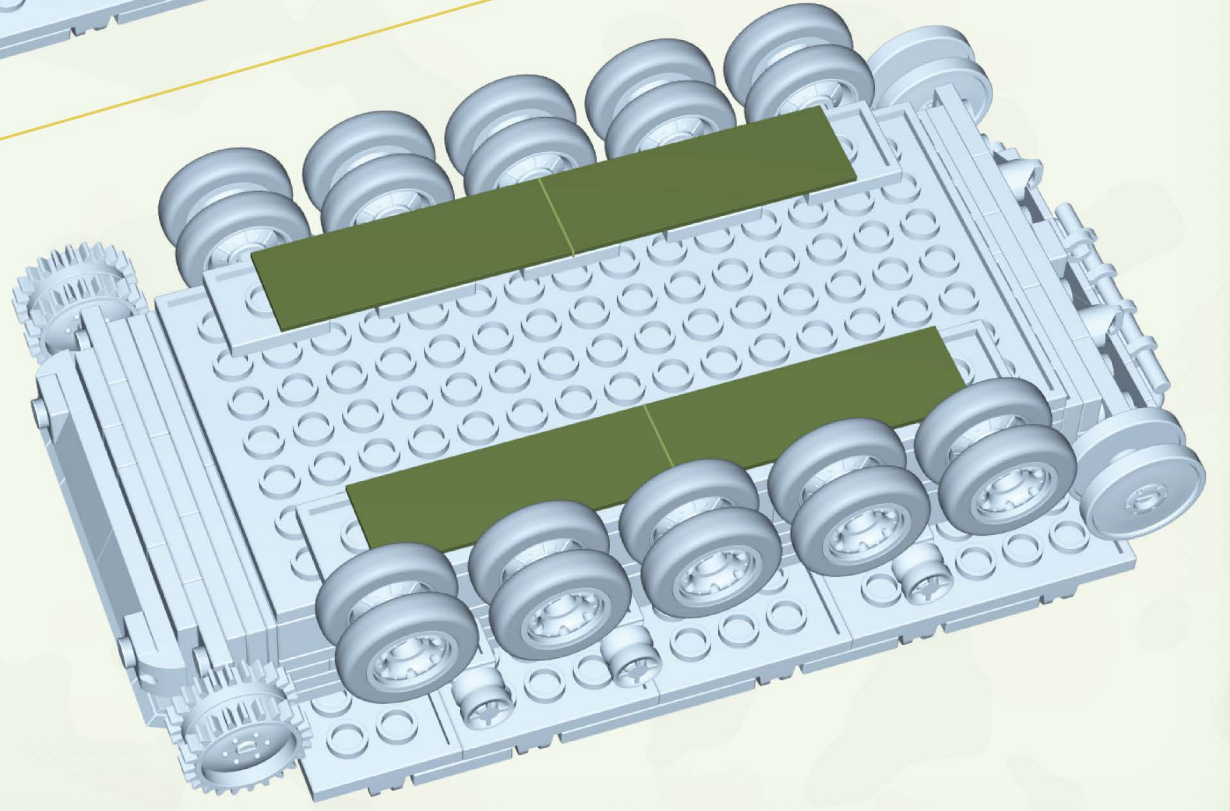

73

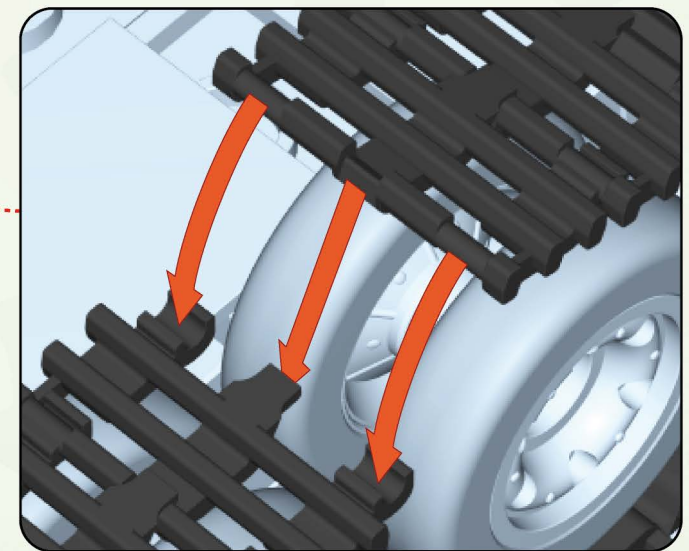
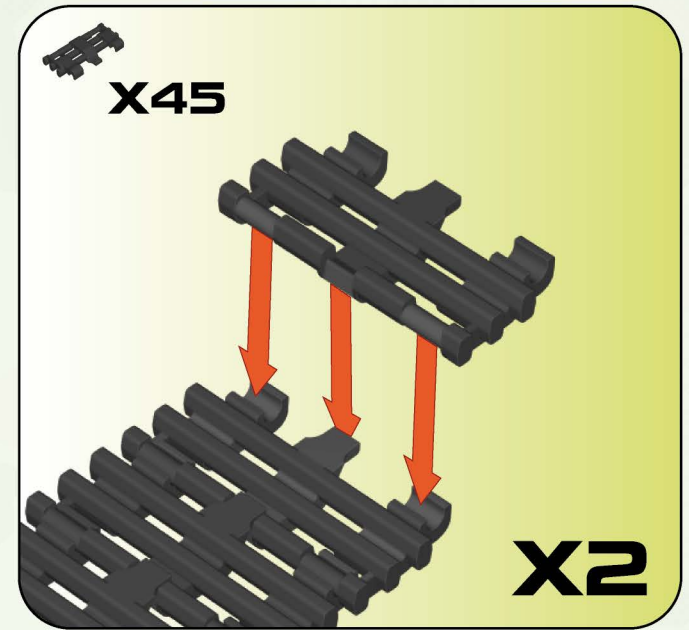
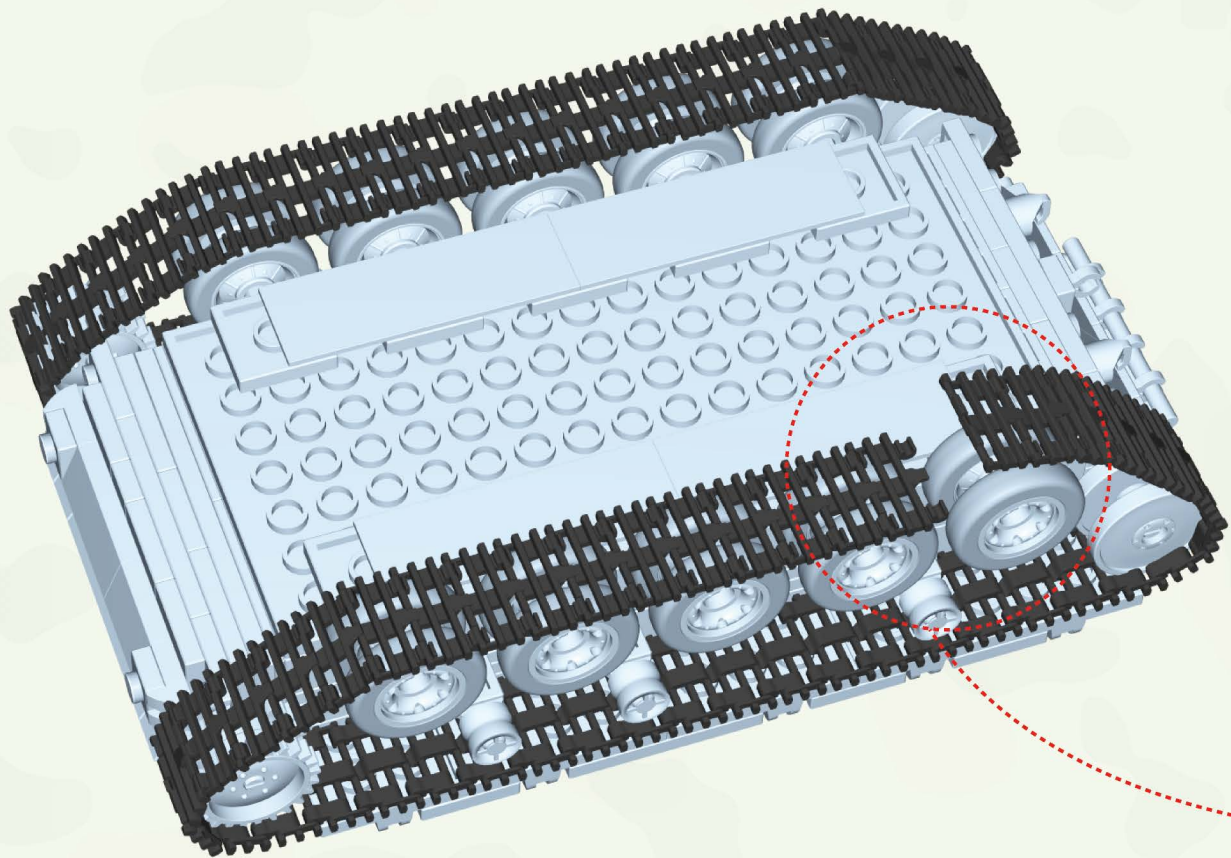

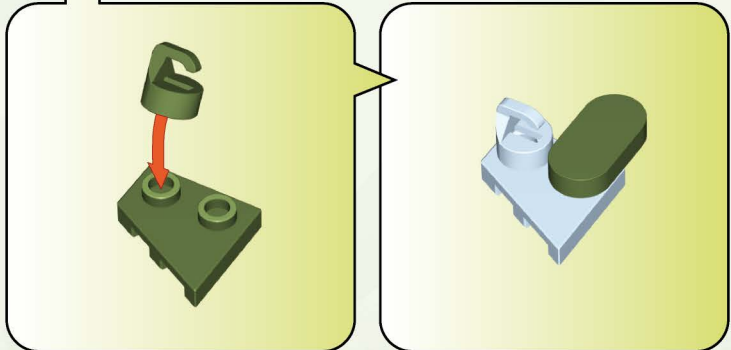
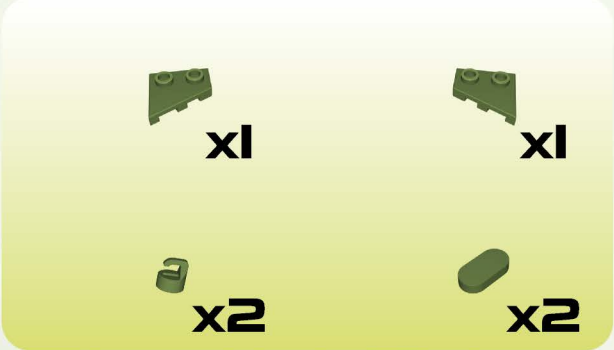
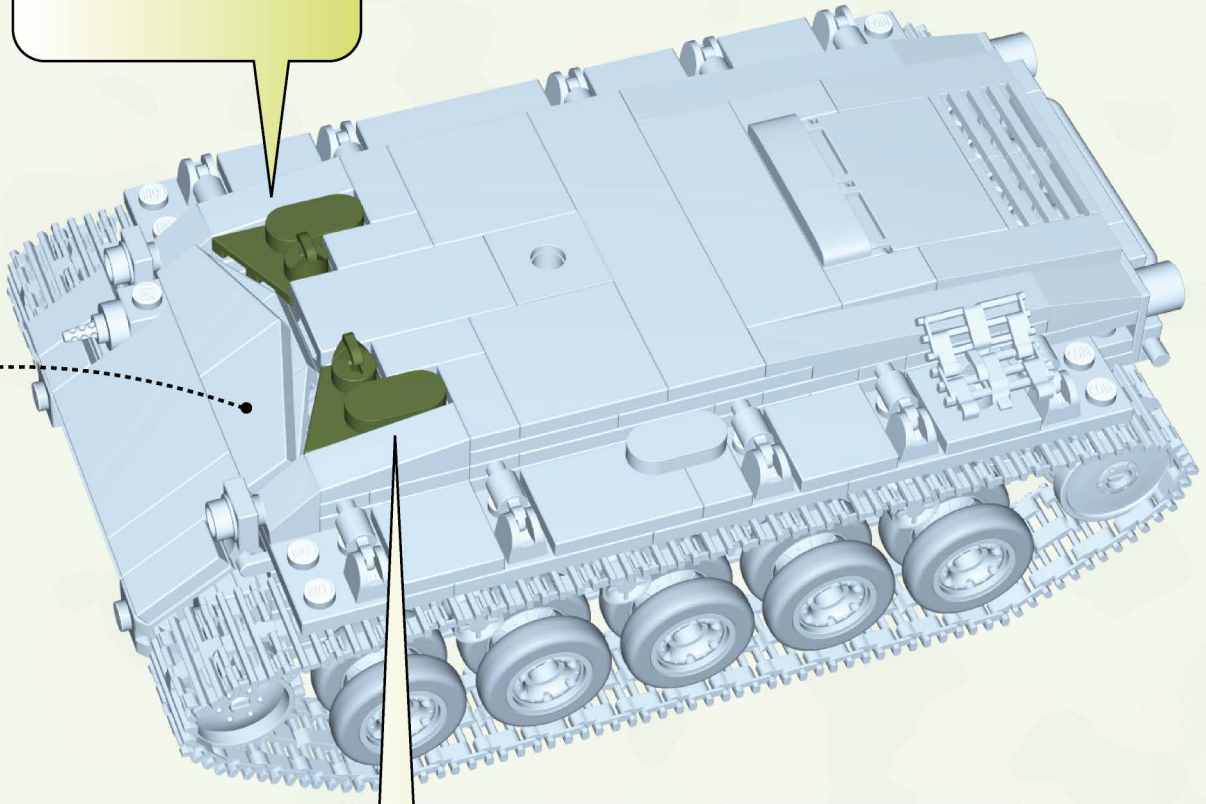
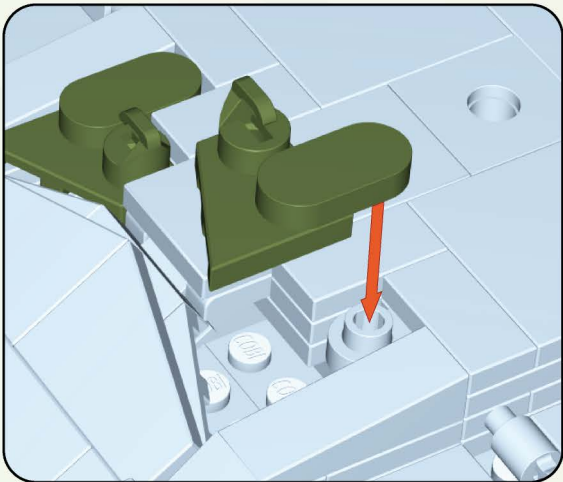
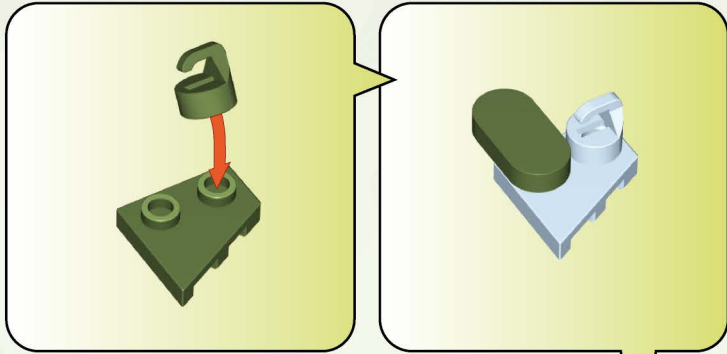

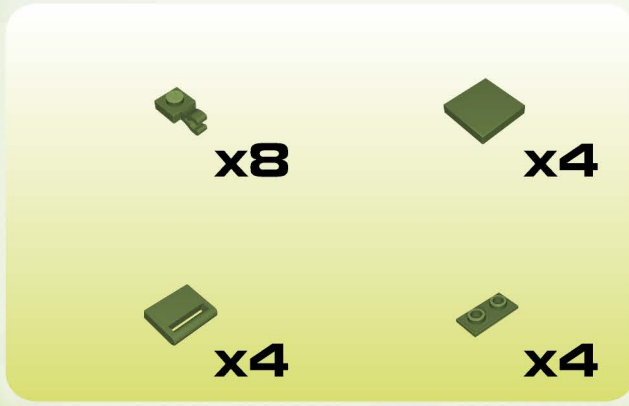
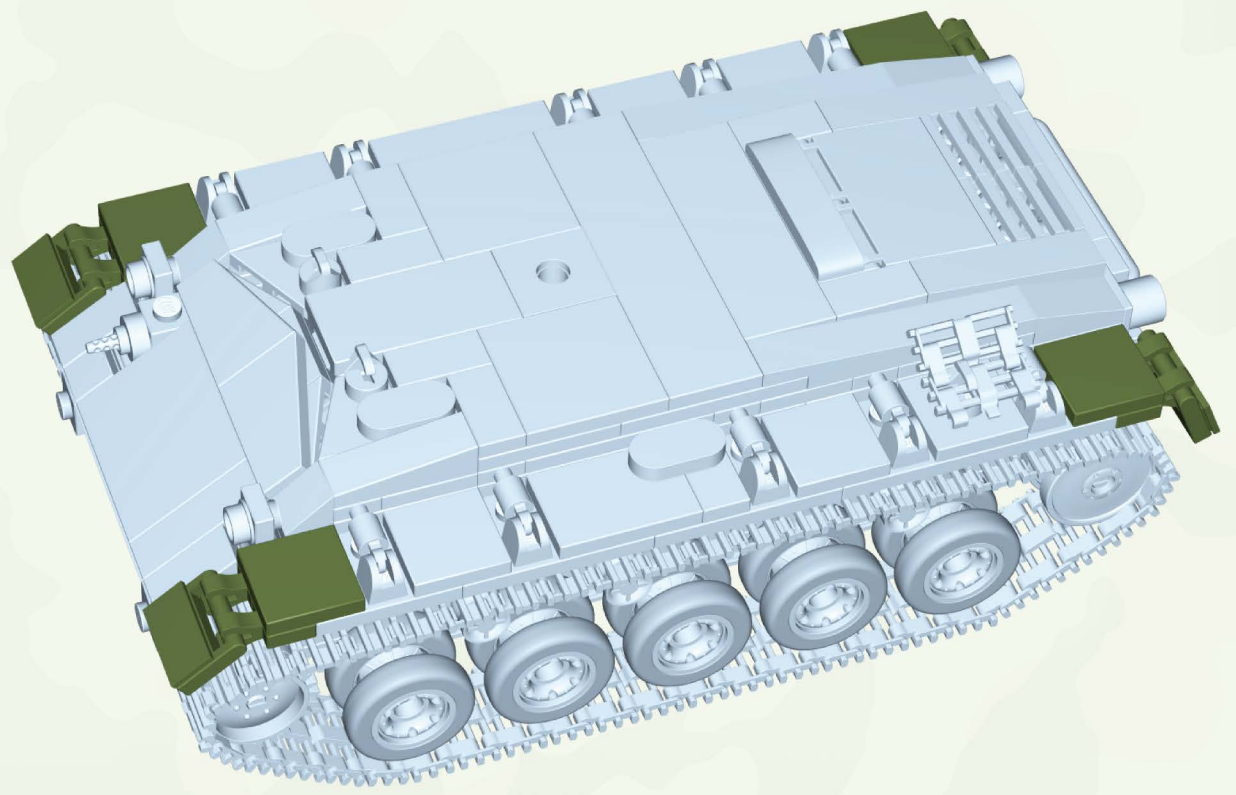
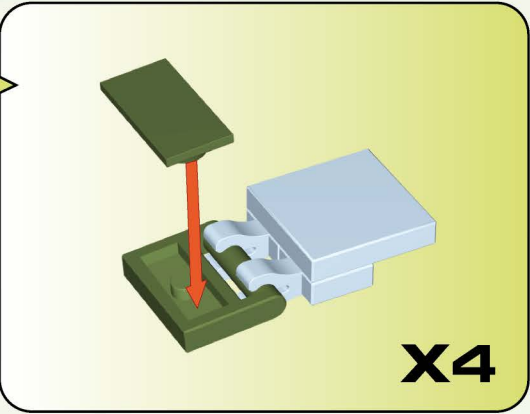
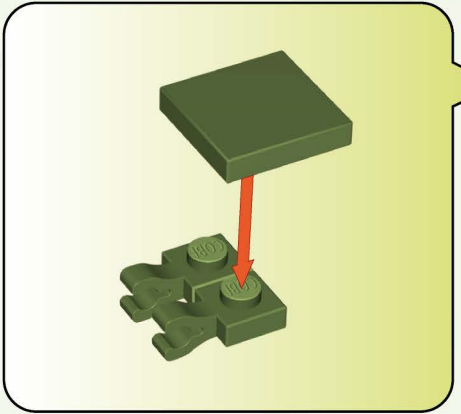

76

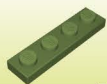

x1



x1

77

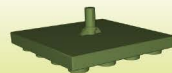
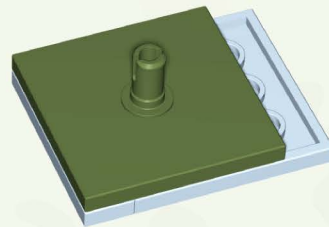

x1

78

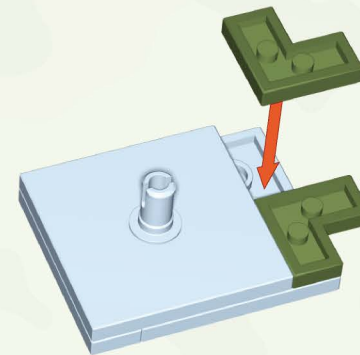

x2

79



x1



x1

80

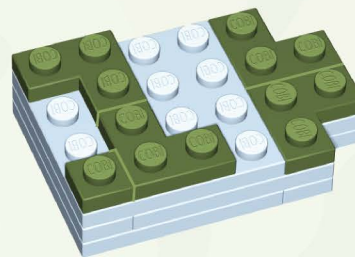

x1



x4

81

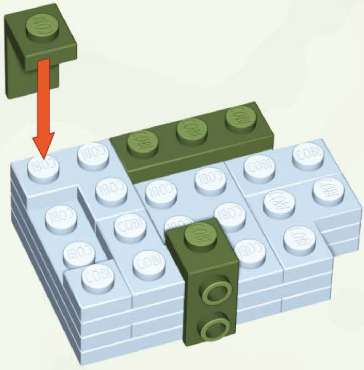

x2



x1

82

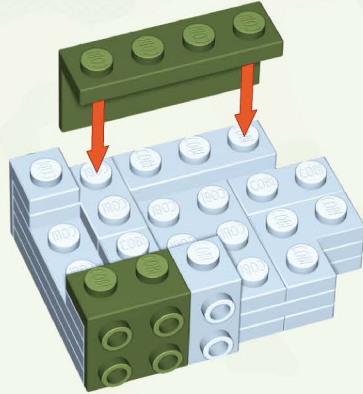

x1



x1

83

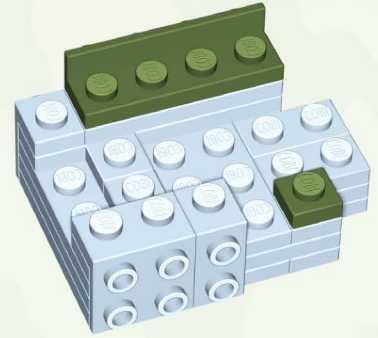

x1



x1

84

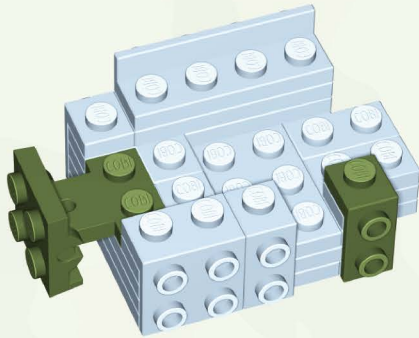
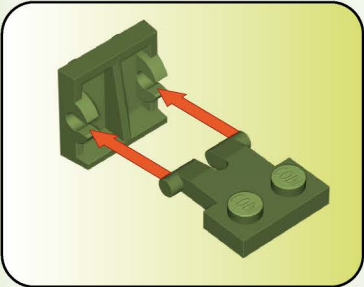

x1



x1



x1

85

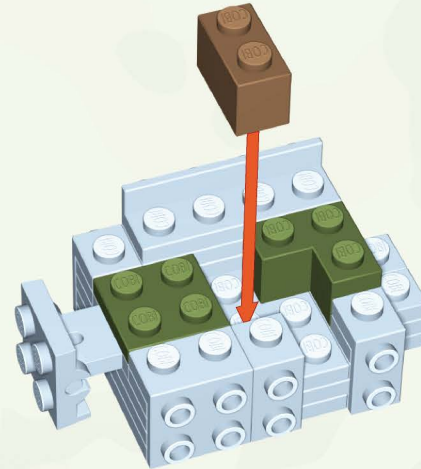

x1



x1



x1

86

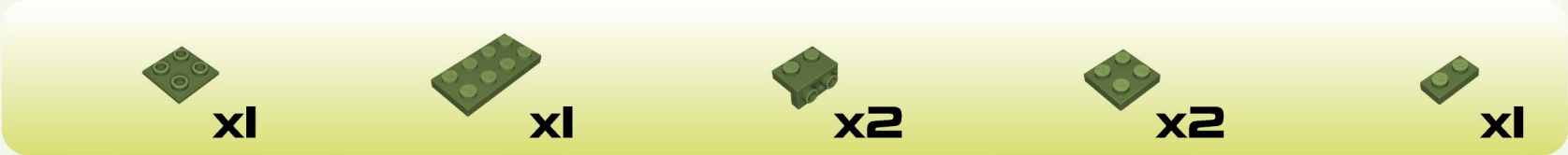
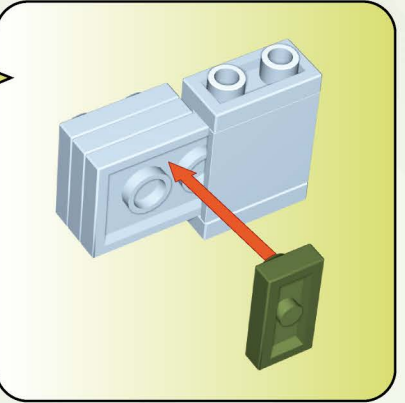
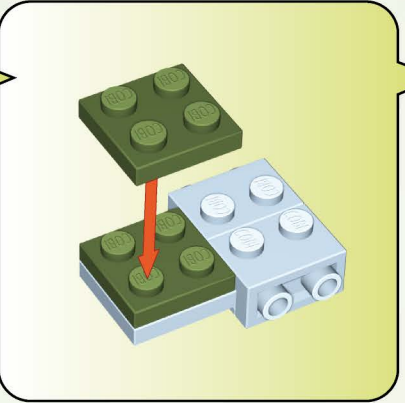
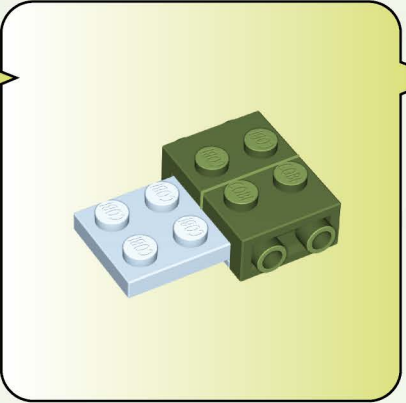
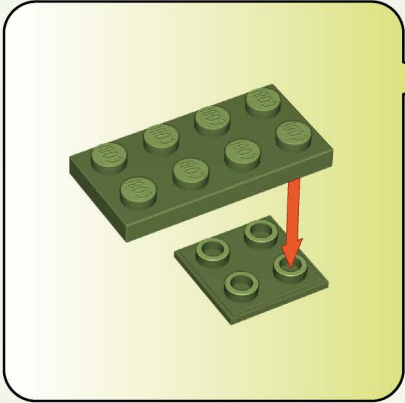

87

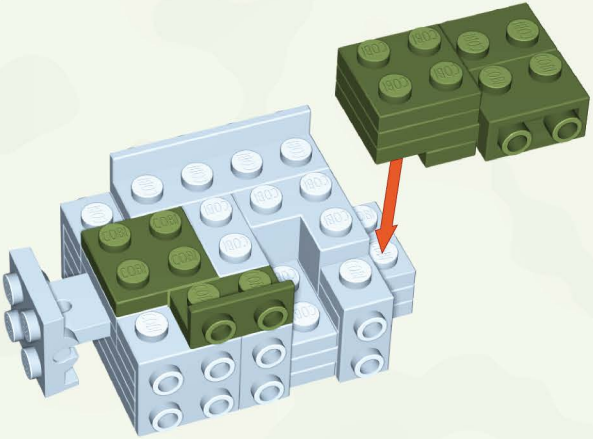

88



89

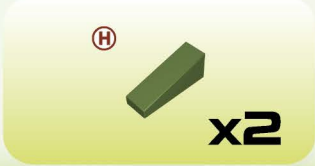

90



91

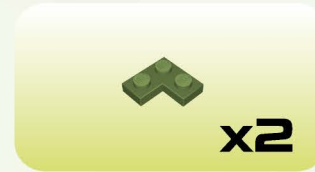
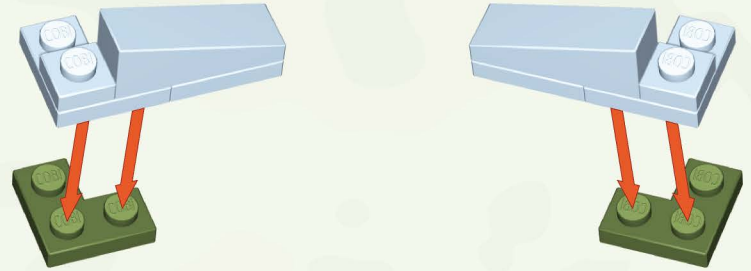

92

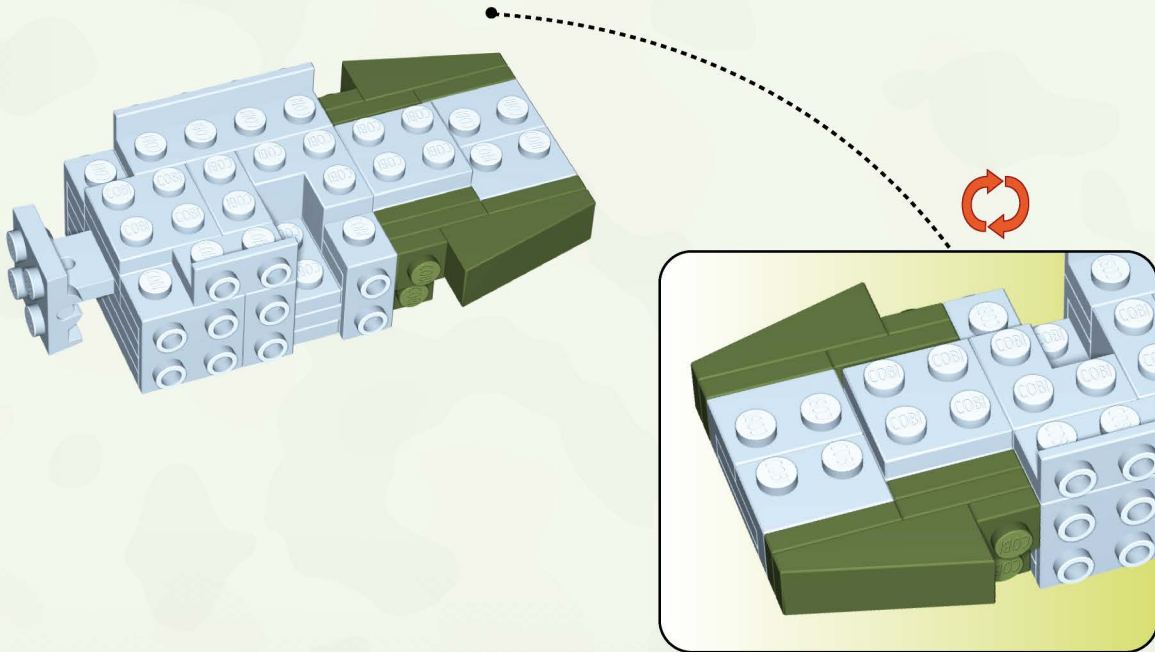

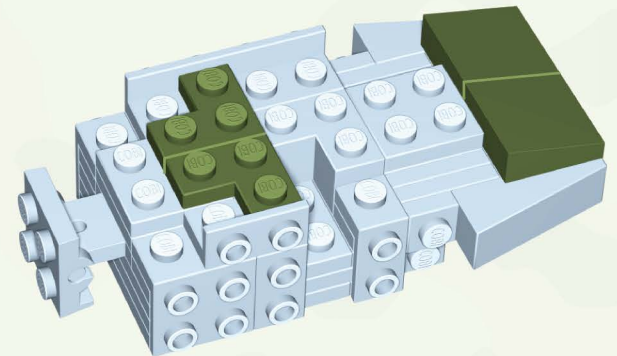

93

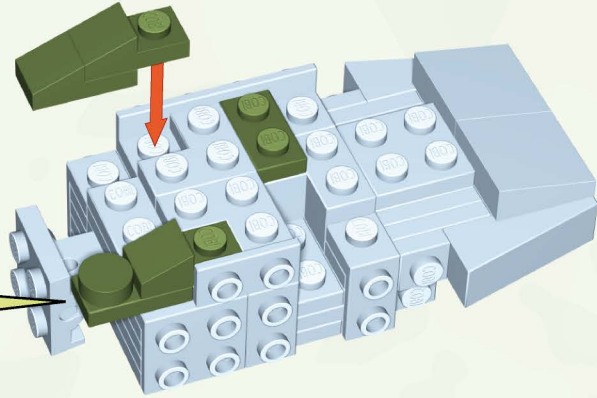
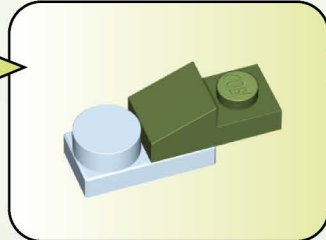
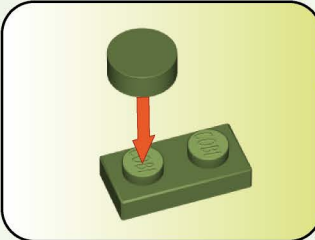
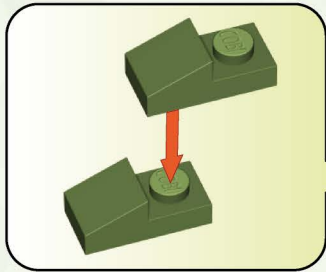

94



-  x3
-  x2
-  x1

95

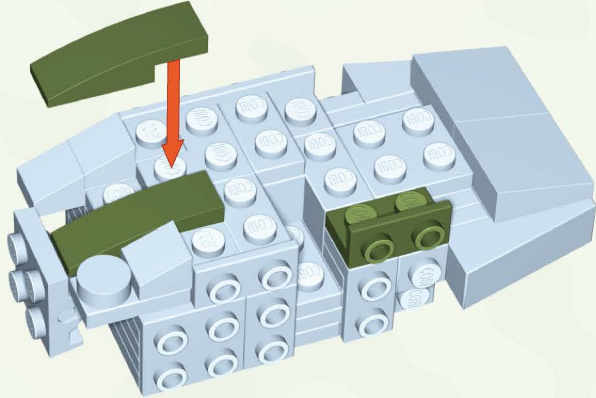

-  x2
-  x1

96

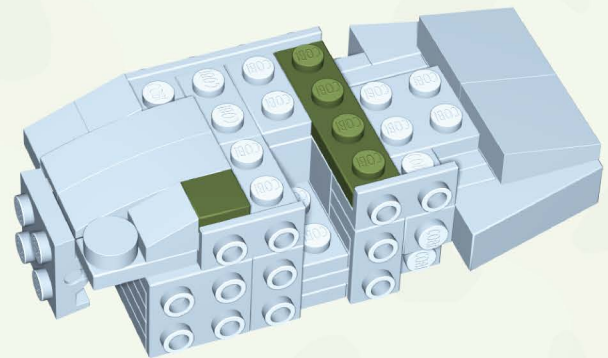

-  x1
-  x1

97

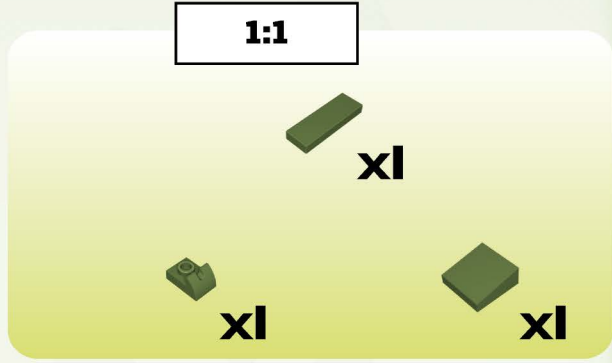
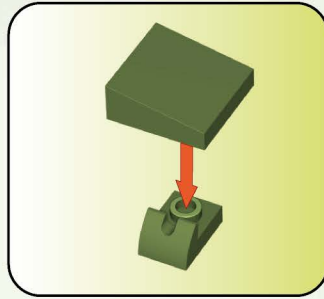
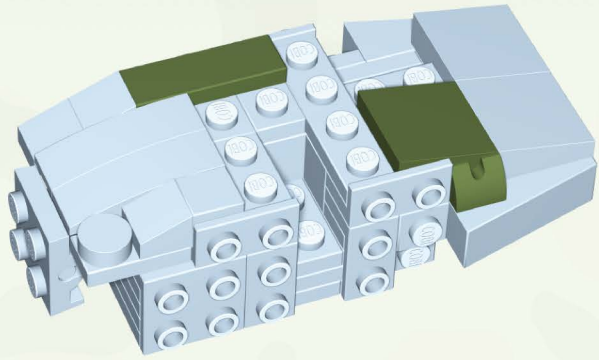

98

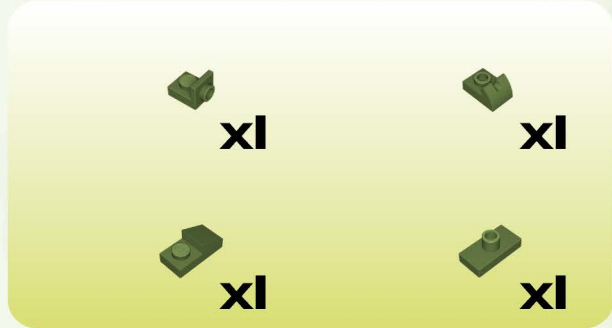
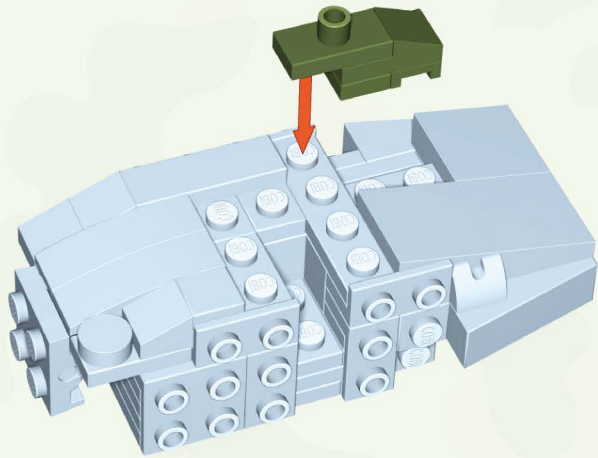
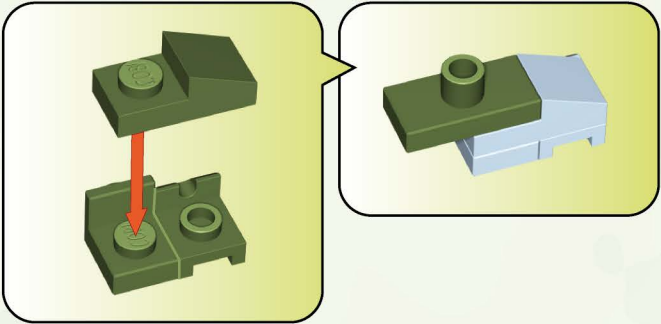

99

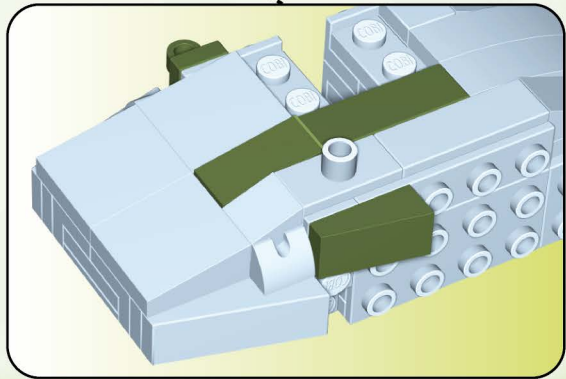
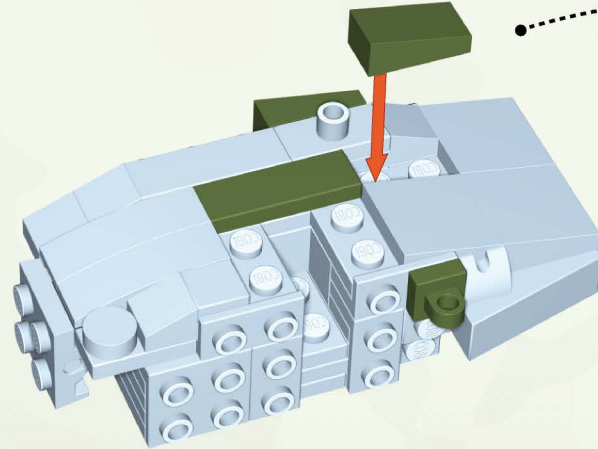
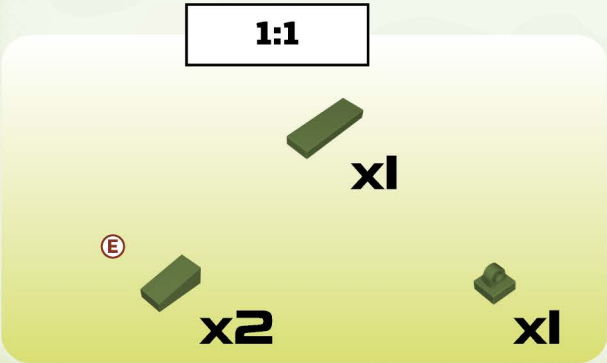

100

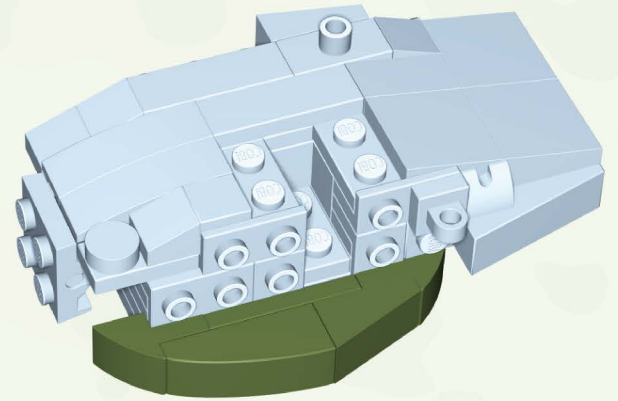
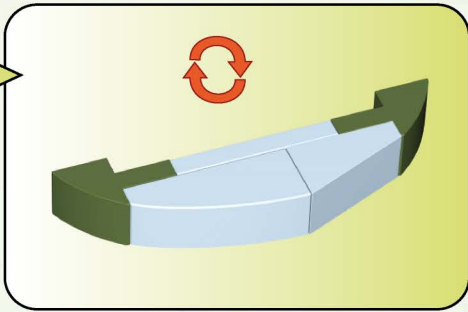
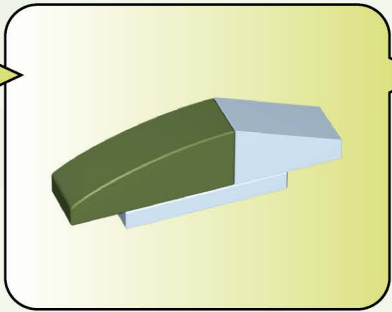
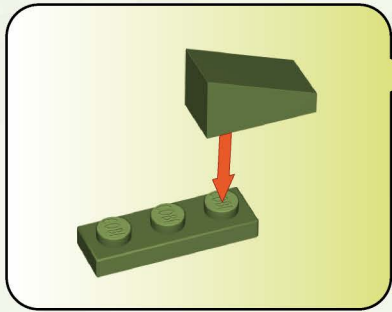

101

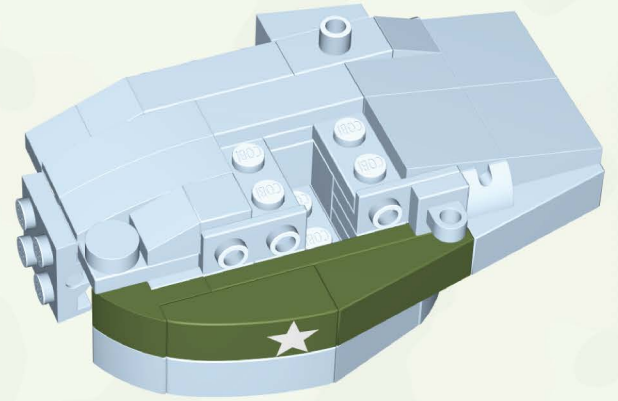
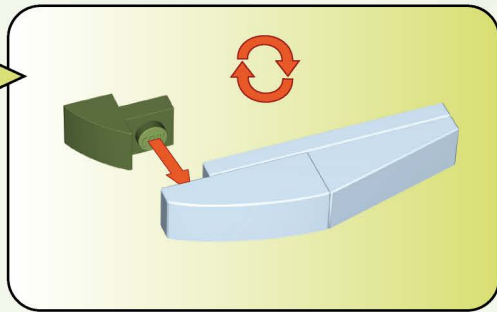
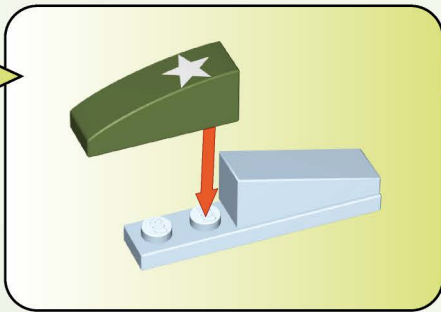
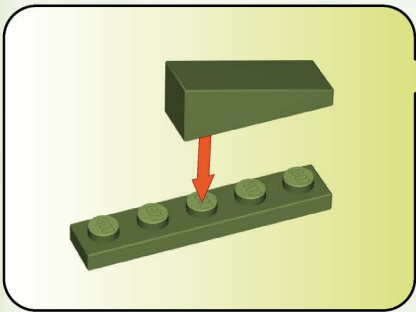

102

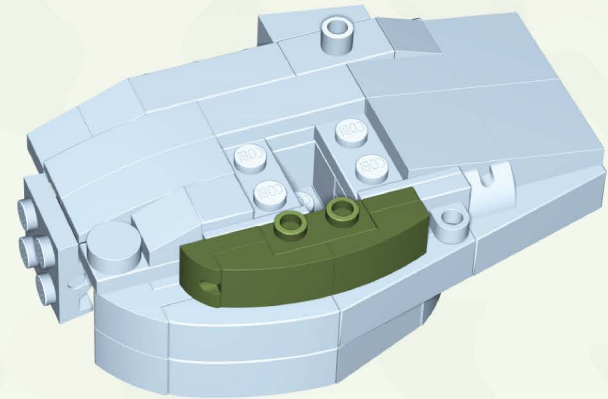
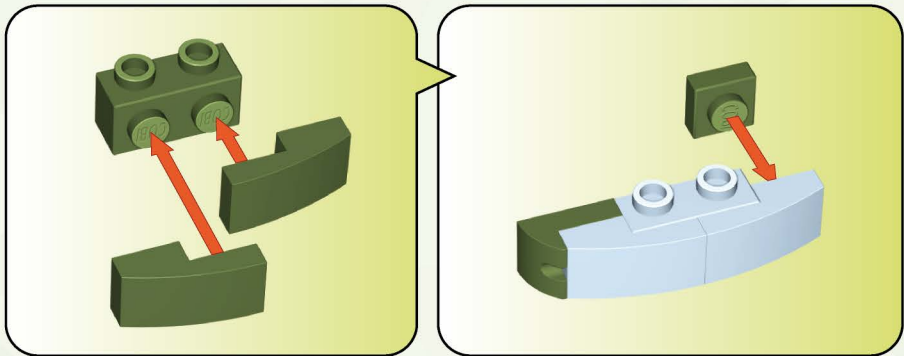

103

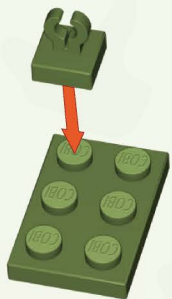

104

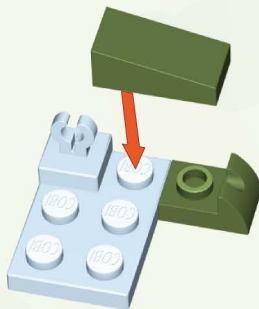

105

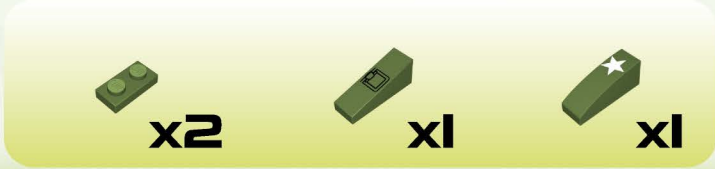
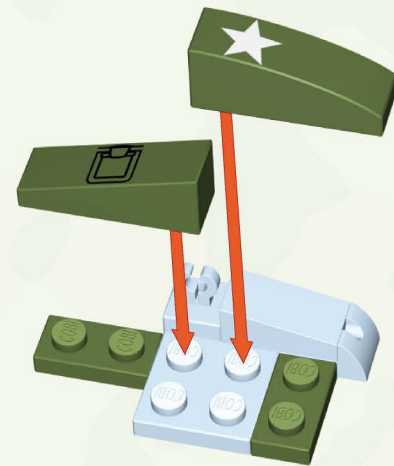

106

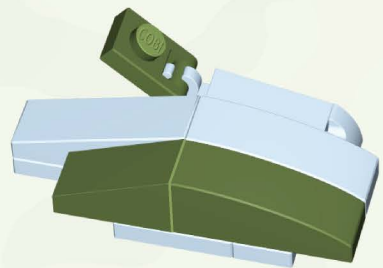

107

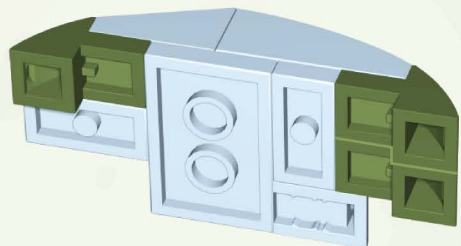

108

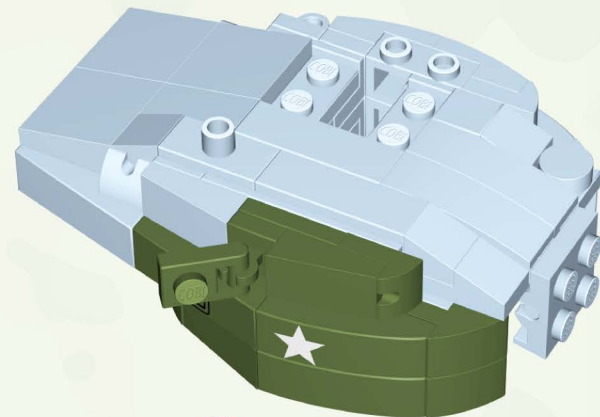

109

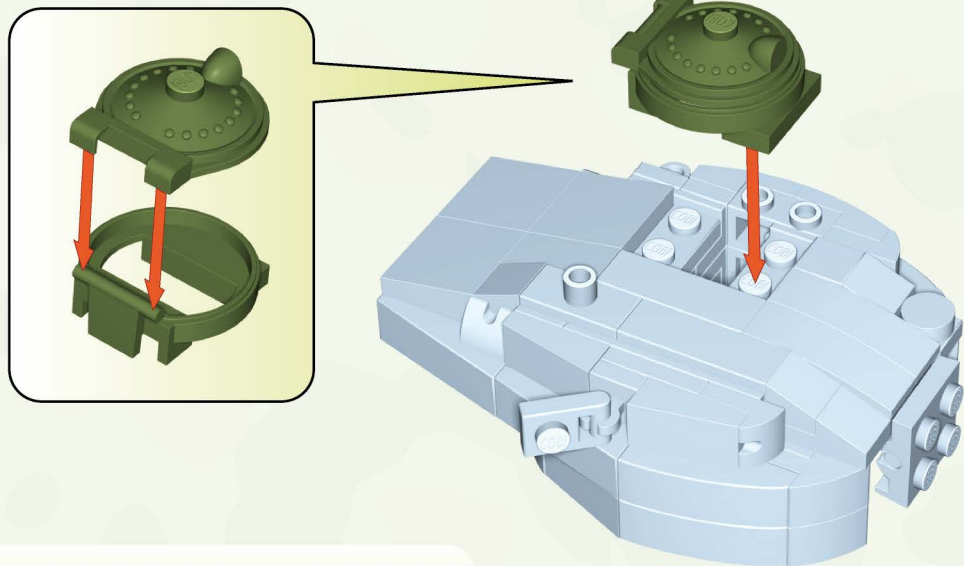

110

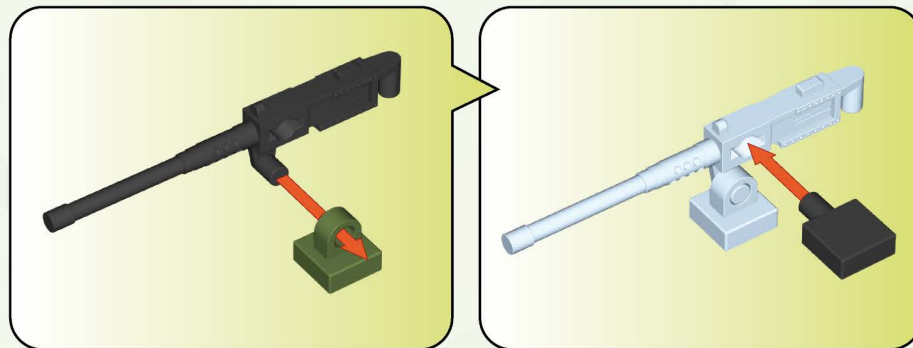

III

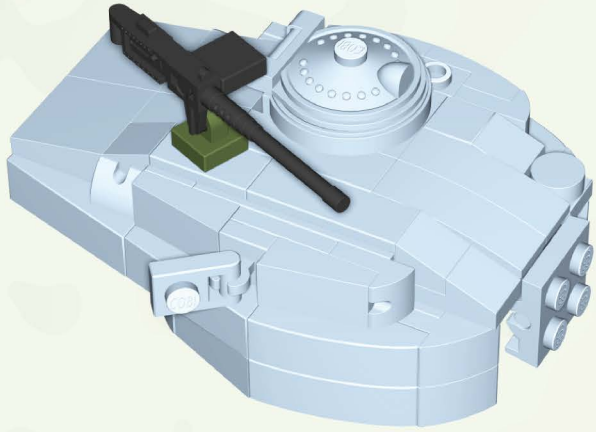

II2

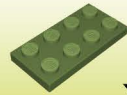
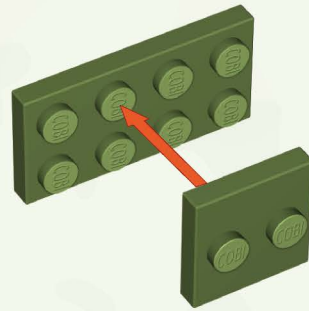

x1



x1

II3

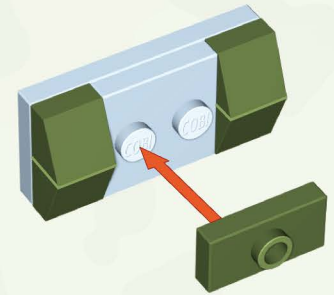

A



x4



x1

II4

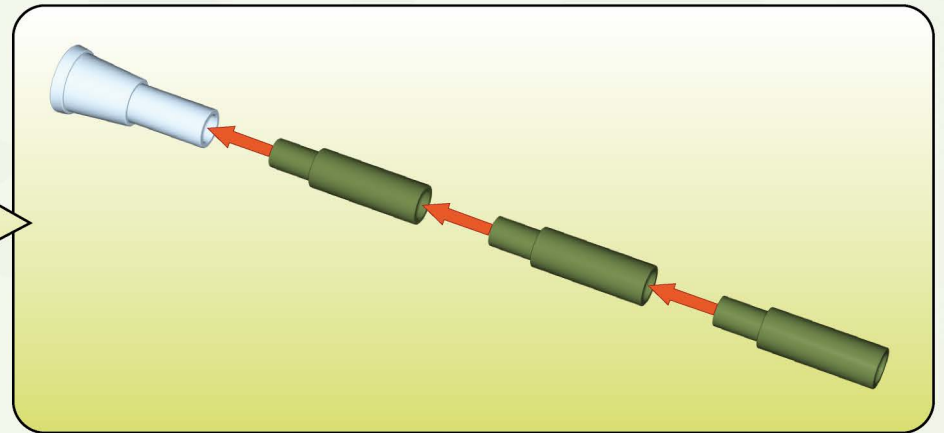
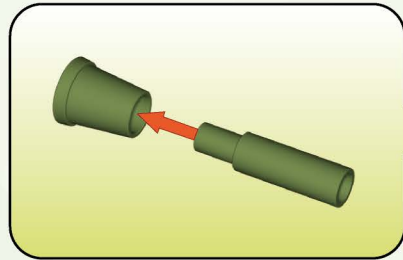

x1



x4

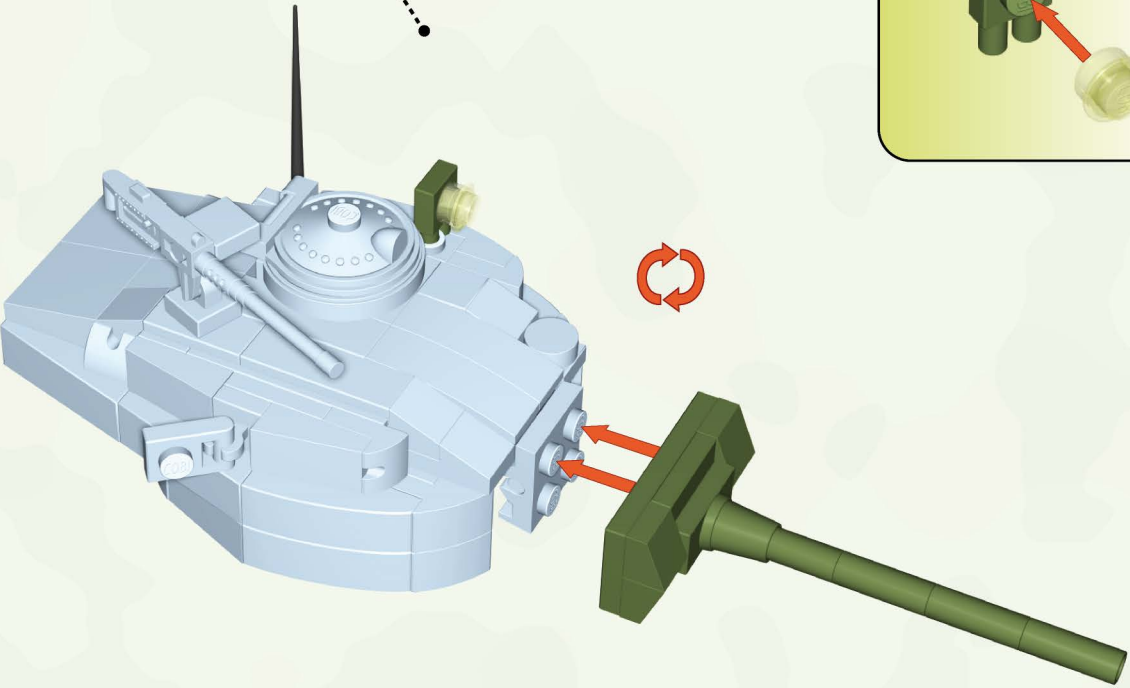
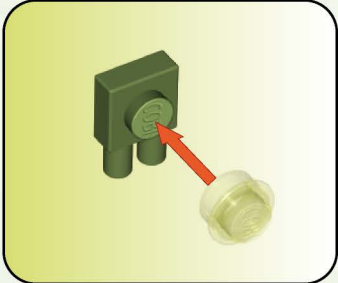

-  **x1**
-  **x1**
-  **x1**

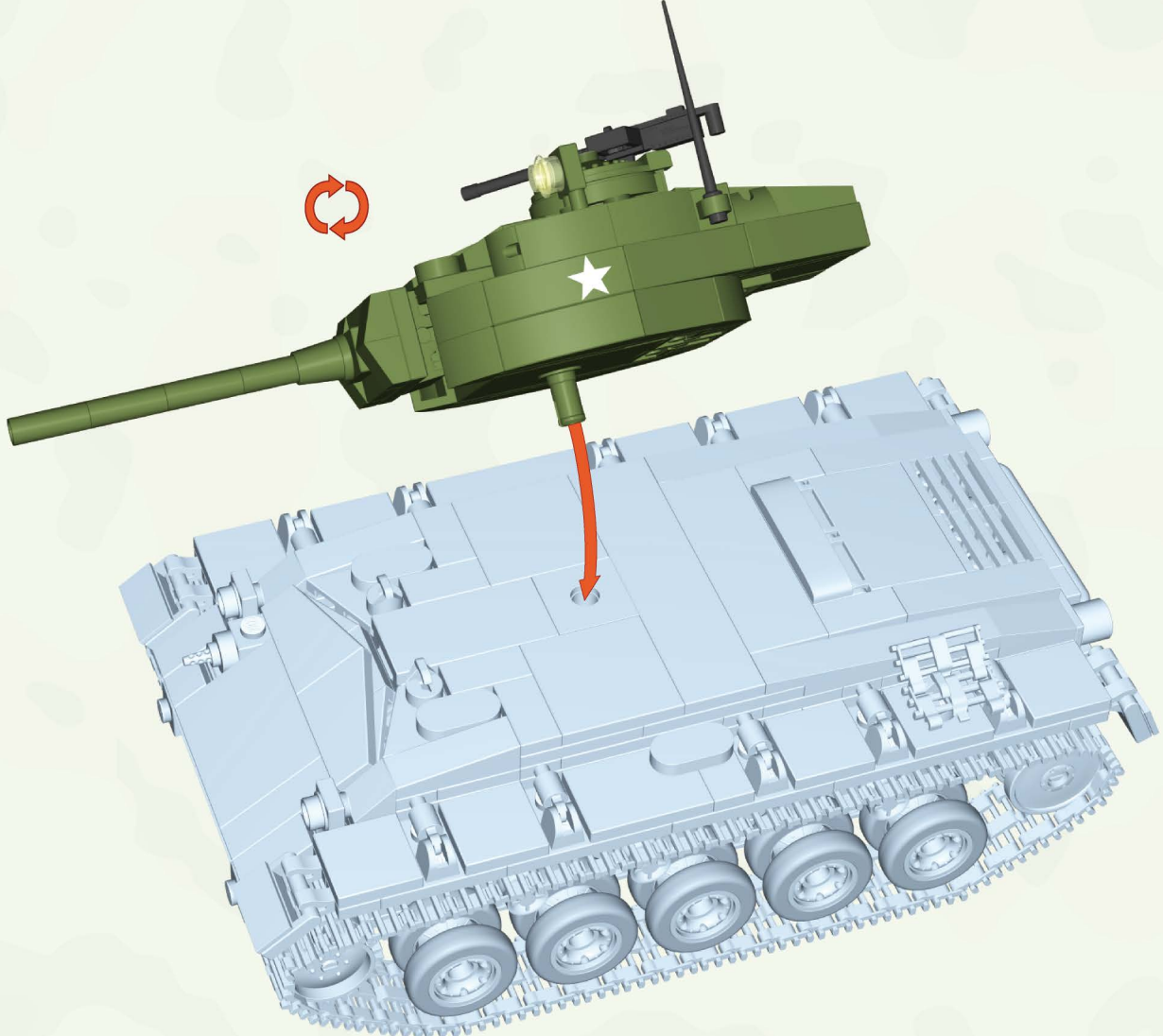

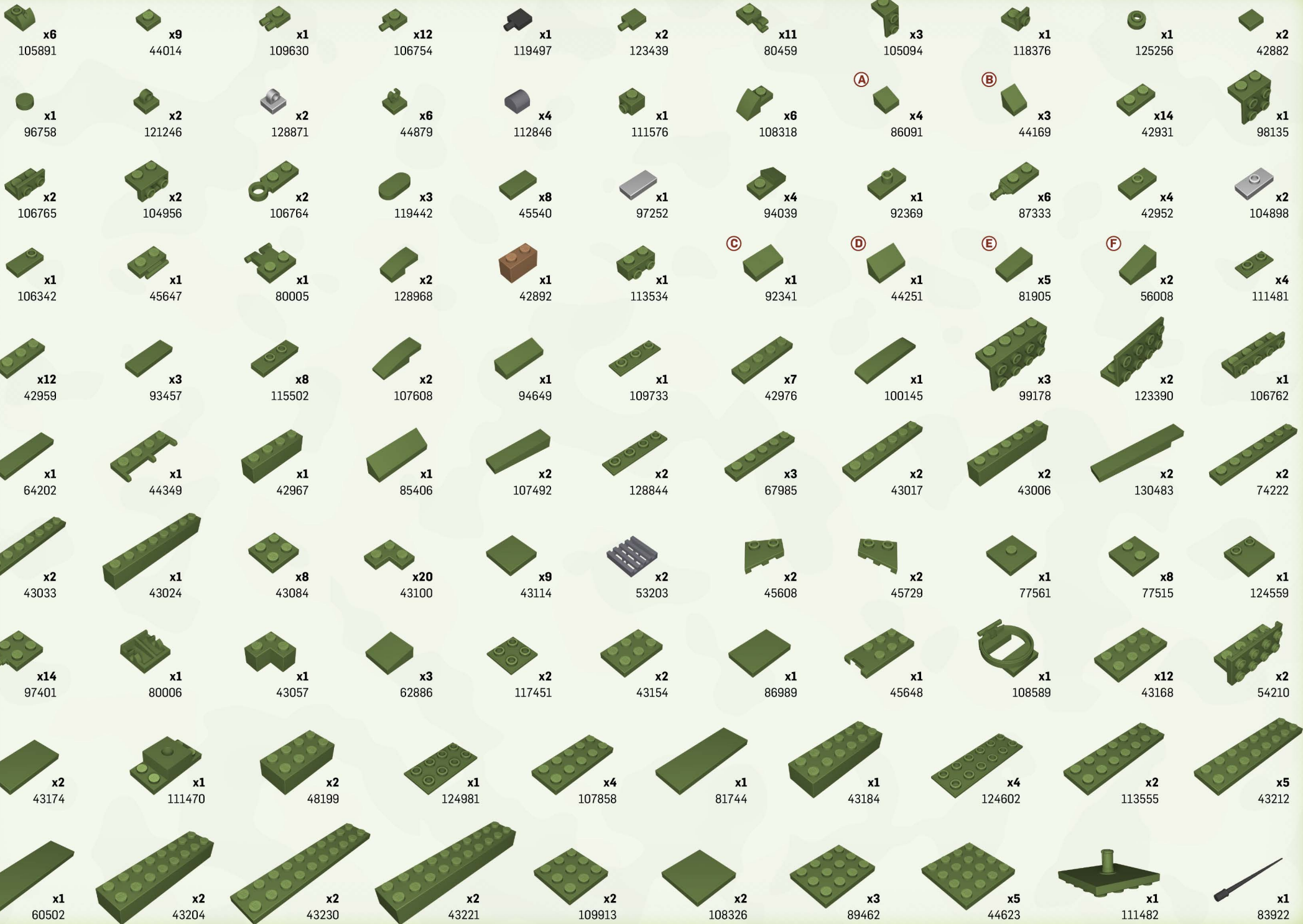





PANZER V PANTHER
SCALE 1:48
+ 2704



M4A3E8 SHERMAN
SCALE 1:48
★ 2705



PANZER III AUSF E
SCALE 1:48
+ 2707



1938 MERCEDES 770
+ 2407



1937 MERCEDES 230
+ 2251



1939 MERCEDES G4
+ 2409

HISTORICAL COLLECTION

2543

M24 CHAFFEE

TABLE POINT

1.	→	28 cm	11.		5
2.	←	10 cm	12.		1
3.	↔	-5 cm	13.		2
4.	↔	-5 cm	14.		2
5.	→	+10 cm	15.		1
6.	🎯	3-6	16.		1
7.	↻	5-6	17.		1
8.	🎲	9	18.		5
9.	💥	2+	19.		70
10.		4	20.		Available 1944



2543



PANZER VI TIGER
SCALE 1:48
+ 2703



SU-100
★ 2541

HISTORICAL COLLECTION

WWW.COBIGAMES.COM

M24 CHAFFEE



A22 CHURCHILL MK. II (CS)
SCALE 1:48
★ 2709



T34/76
SCALE 1:48
★ 2706

WWW.COBI.EU

01-02543-578

For news and special deals

Find us on:

