



77052



Q LEGO® Builder



[LEGO.com/sustainable-packaging](https://LEGO.com/sustainable-packaging)



FR

**DONNEZ**  
OU  
**RECYCLEZ**



OU



OU



ASSOCIATION

MAGASIN

DÉCHÈTERIE

Adresses sur [quefairedemesdechets.fr](https://quefairedemesdechets.fr)

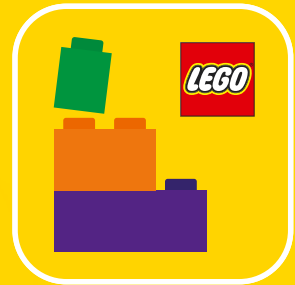

🔍 LEGO® Builder

# BUILDER

Download on the  
App Store

GET IT ON  
Google Play

腾讯应用宝  
安卓应用商店

Apple and the Apple logo are trademarks of Apple Inc., registered in the U.S. and other countries and regions. App Store is a service mark of Apple Inc. Google Play and the Google Play logo are trademarks of Google LLC. Tencent and the Tencent logo are trademarks of Tencent Inc.

🔍 [LEGO.com/devicecheck](https://LEGO.com/devicecheck)

EN Ask parents' permission before going online | DE Eltern um Erlaubnis bitten, bevor du online gehst | FR Demande l'autorisation d'un parent avant d'aller en ligne | IT Chiedi il permesso ai tuoi genitori prima di andare online | ES Pídeles permiso a tus papás antes de conectarte a Internet | PT Pede autorização aos pais antes de acederes online | ZH 上网前应先征得父母的同意 | PL Poproś rodziców o zgodę, zanim wejdiesz do Internetu | CS Než půjdeš na internet, požádej rodiče o svolení | SK Skôr než pôjdeš na internet, vypýtaj si povolenie od rodičov | HU Kérj szülői engedélyt, mielőtt online csatlakoznál! | RO Cere permisiunea părinților înainte de a te conecta online | BG Поискайте разрешение от родител, преди да влезете онлайн | LV Pirms došanās tiešsaistē palūdz atļauju vecākiem | ET Enne Interneti kasutamist küsi vanematelt luba | LT Prieš prisijungdami prie interneto, atsklauskite tėvų

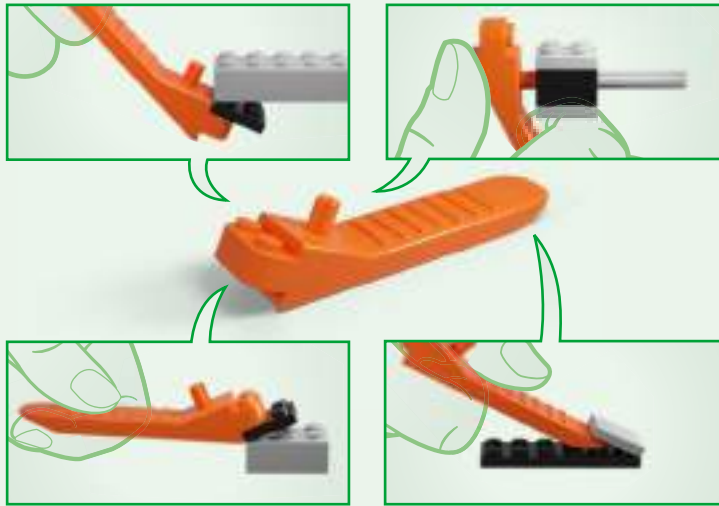





1

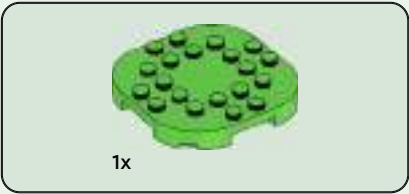

2

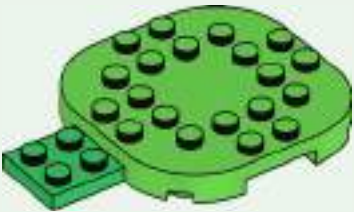



3

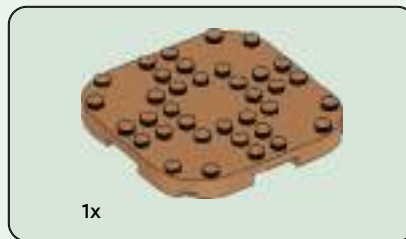

4



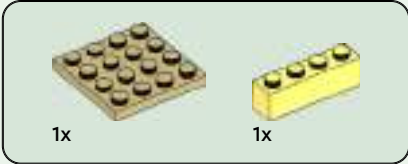

5

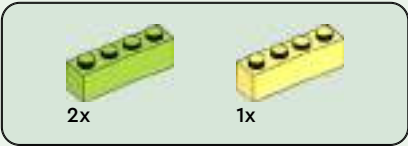

6

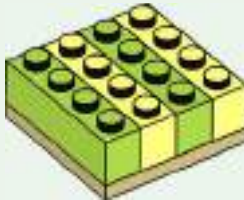





1x

7

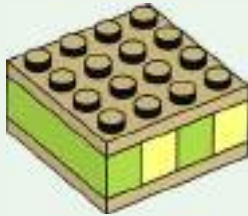

1x

8

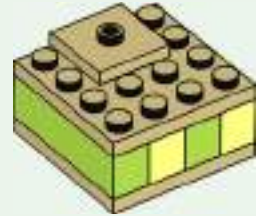



1x



1x

9

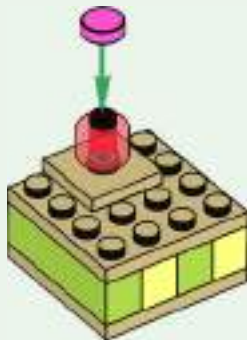

2x

10





1x



1x

# 11



1x



1x



1x



1x



1x

# 12

1



2



3



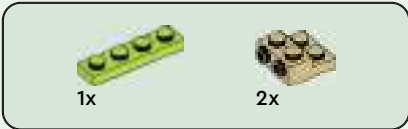

13

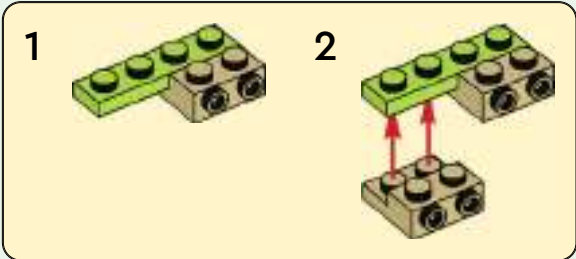

14





1x

15



2x



1x

16





2x



2x

17



18





2x



2x

19

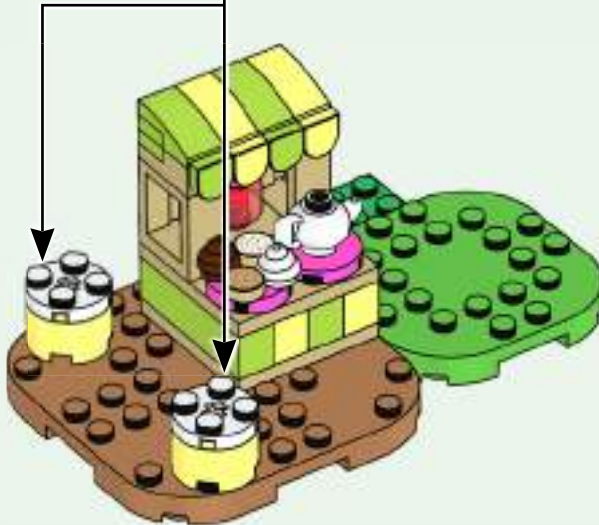
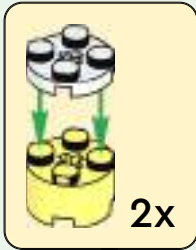

1x

20





1x

1x

21



1x

1x

1x

22

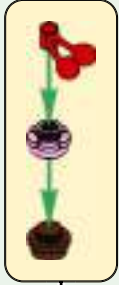





2x



1x

23



24



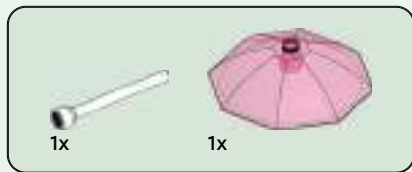

25





26

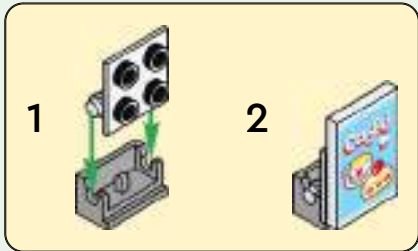

27





2x

28





29

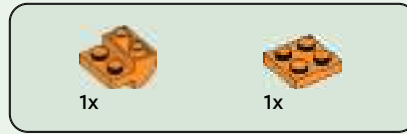
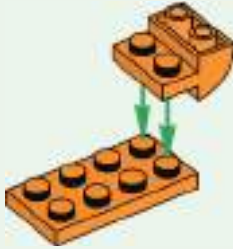

30

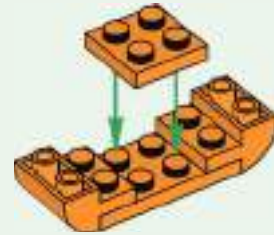



1x

31

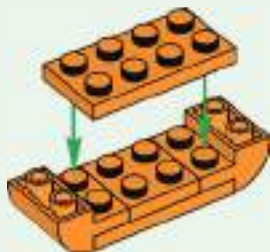

2x

32

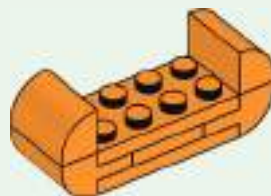



2x

33



2x



1x

34

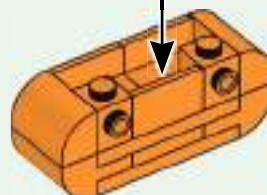
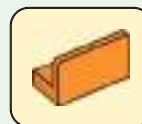

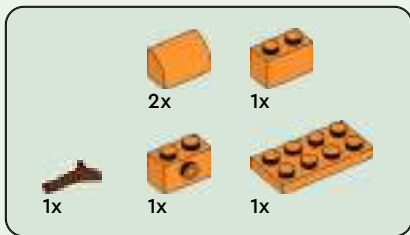

35

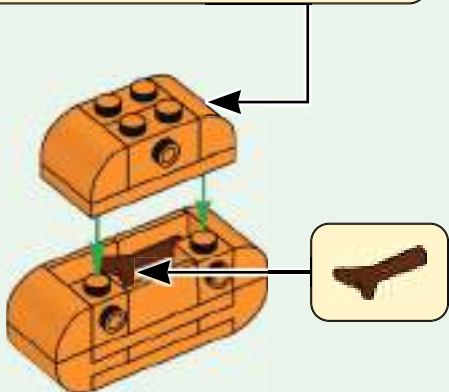
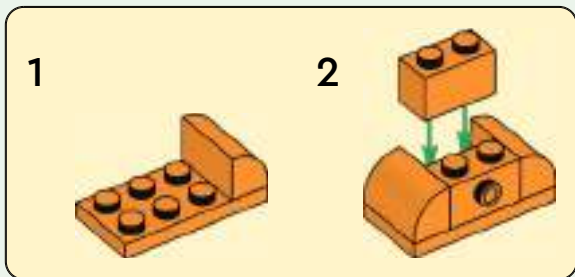

36





37



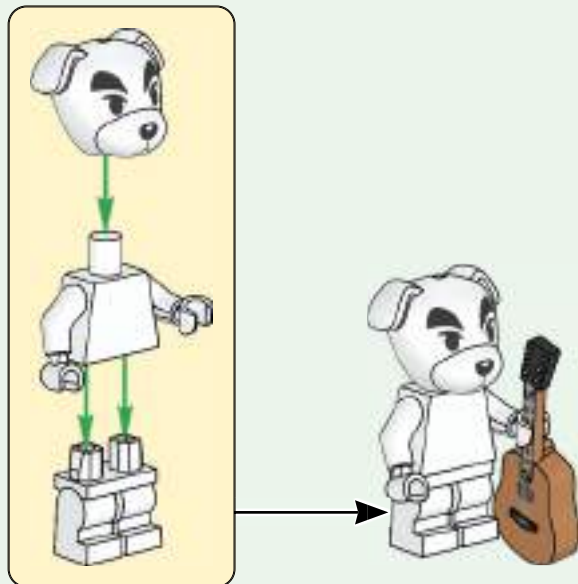





1x

38

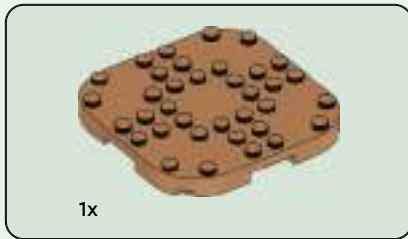
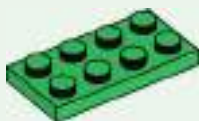

1x

39

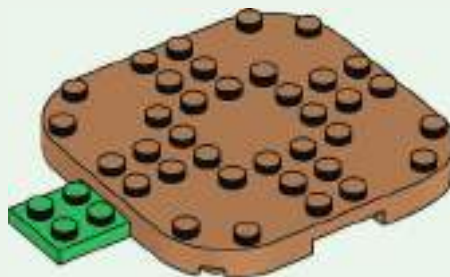

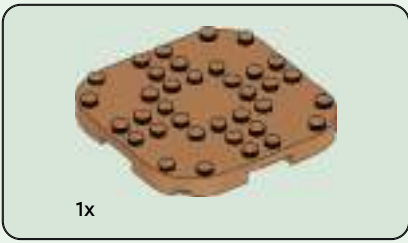

40

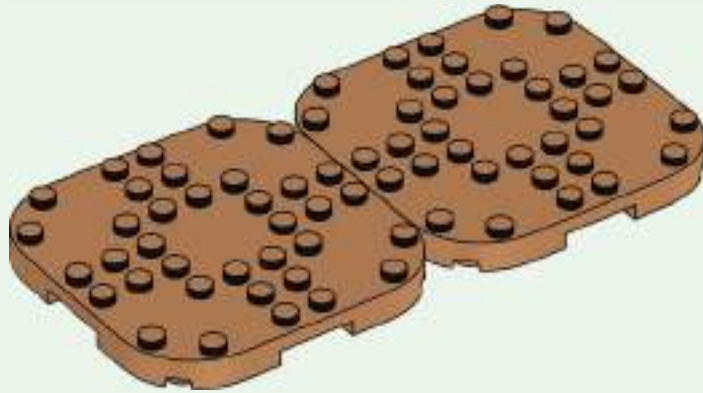



41

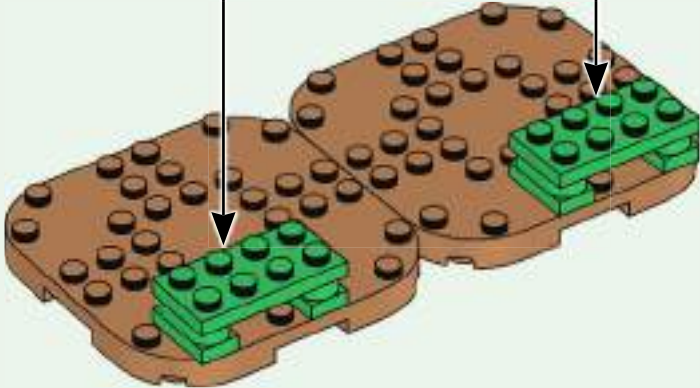



2x

42





# 43

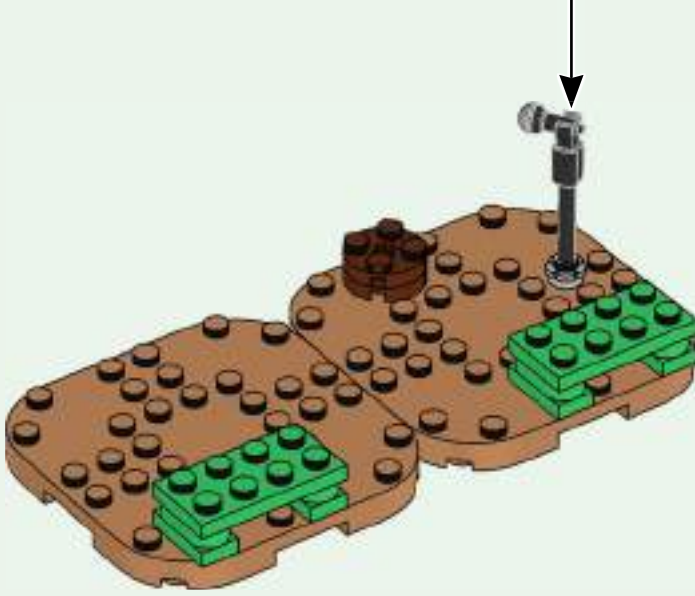
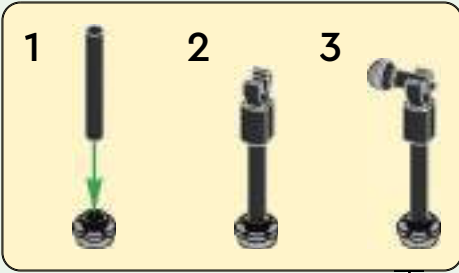



1x

44

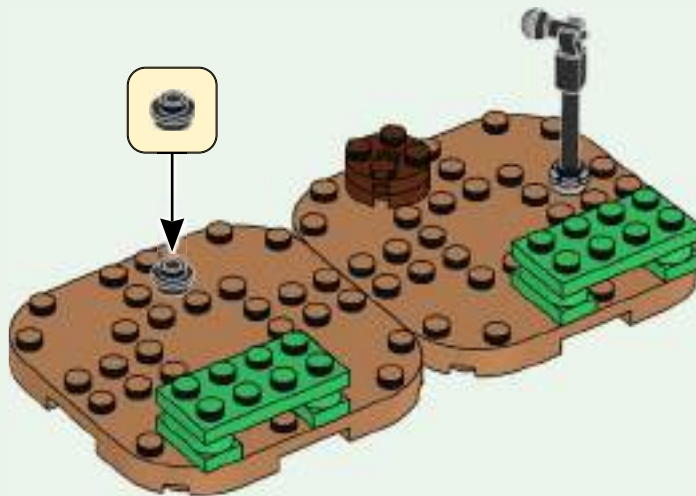



# 45

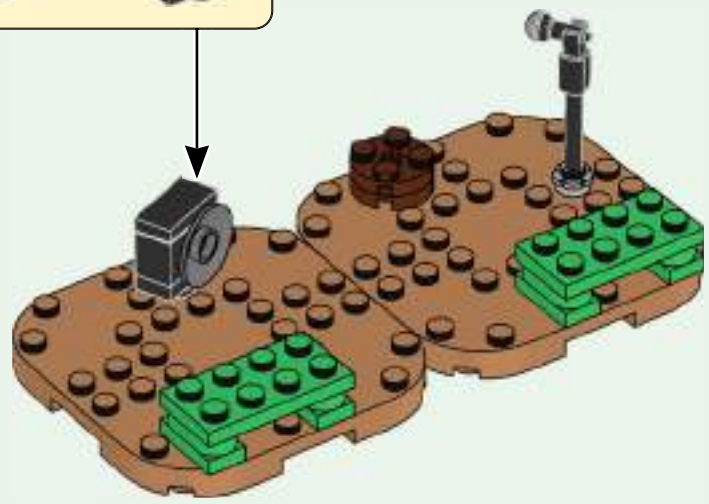



1x

46



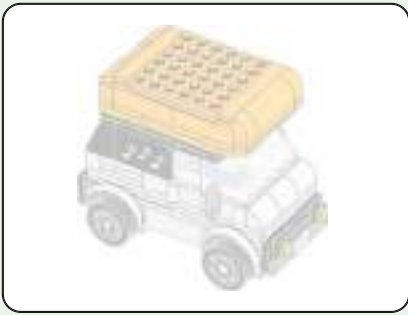

1



2



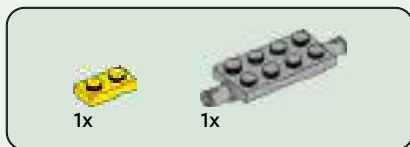

3



4





5



6

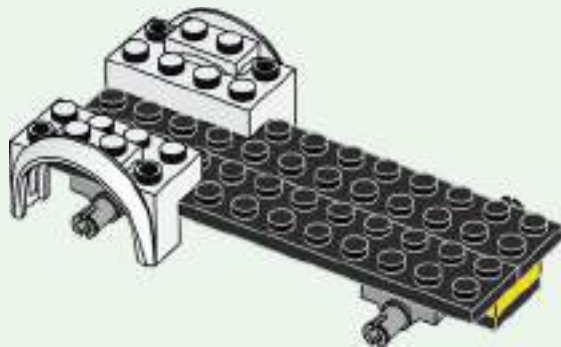



2x

7



2x

8

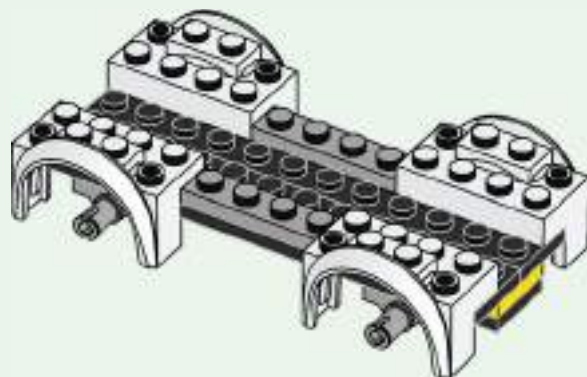



9

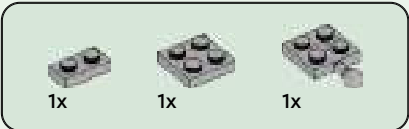

10

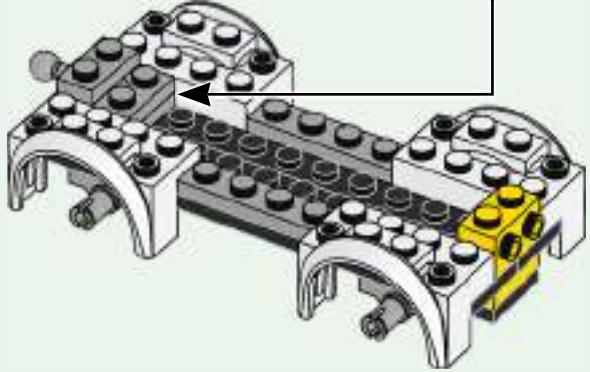
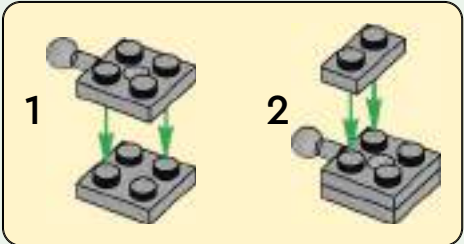





4x

11

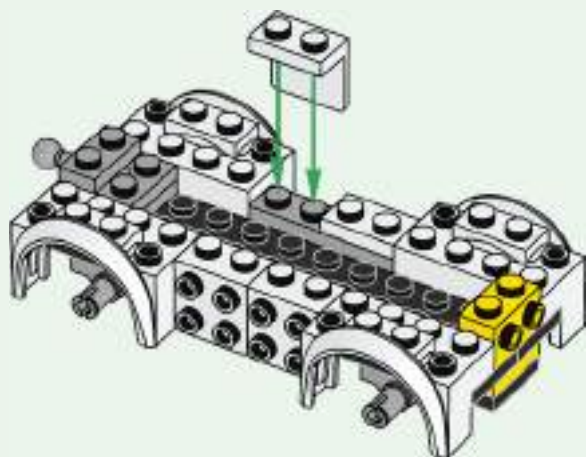

2x

12

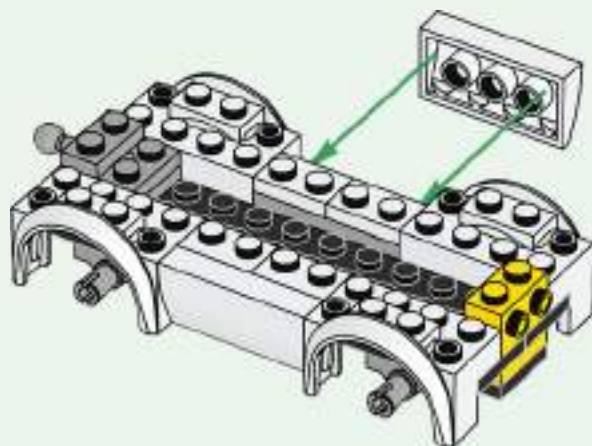



2x

13

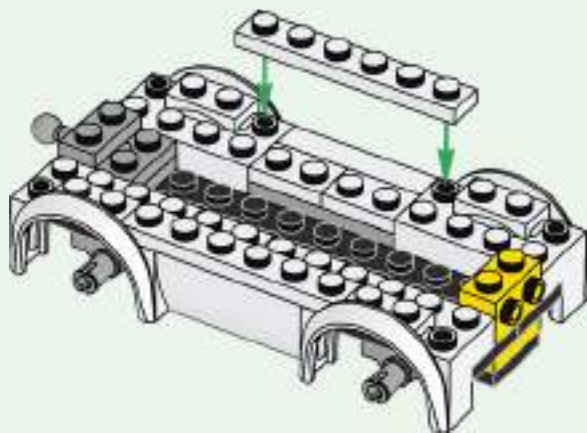

2x

14



2x

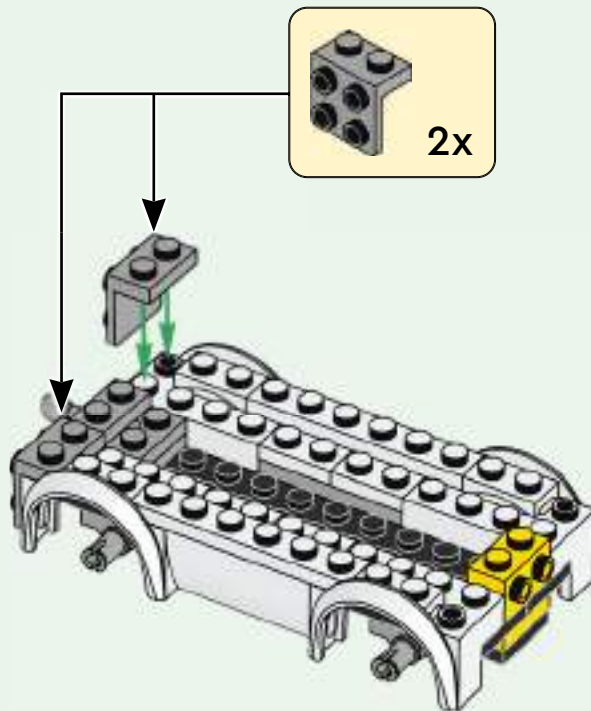



2x

15

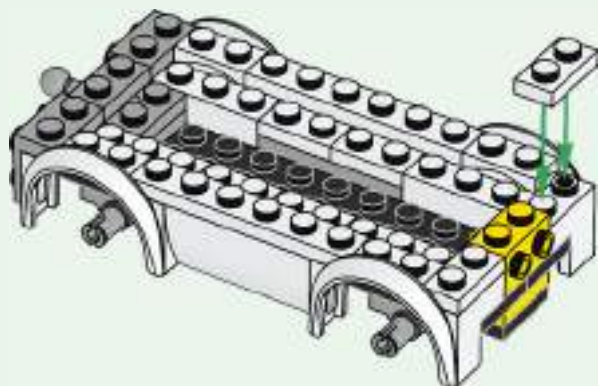

1x



2x

16

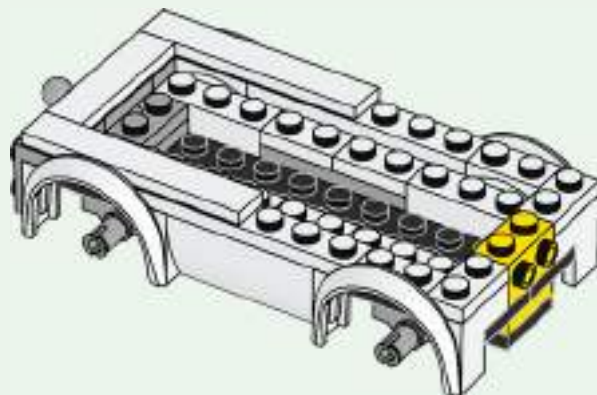



1x

17

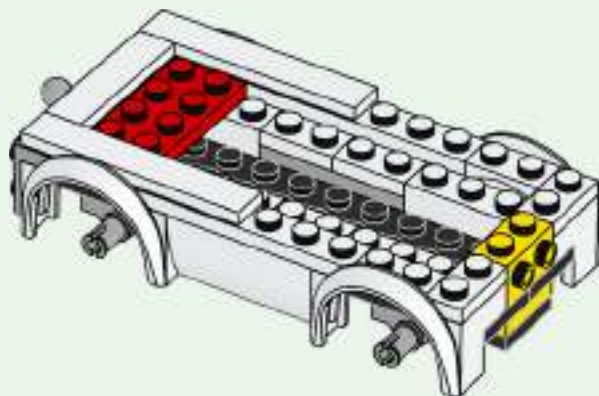

1x

18

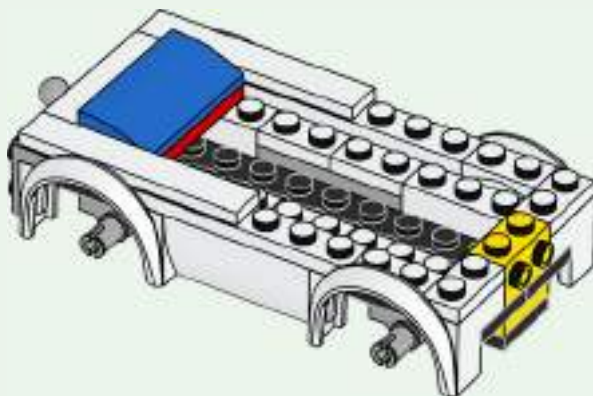

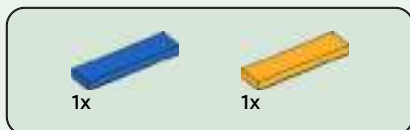

19

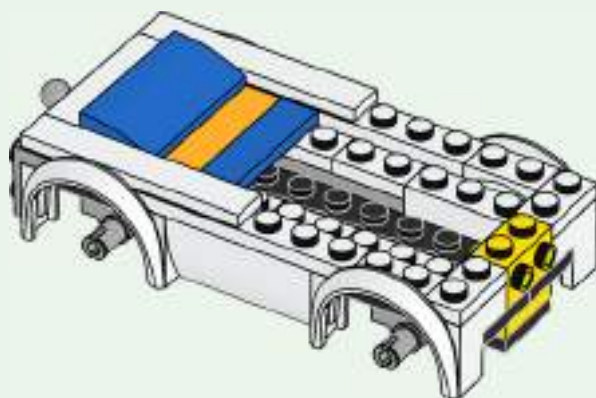

20

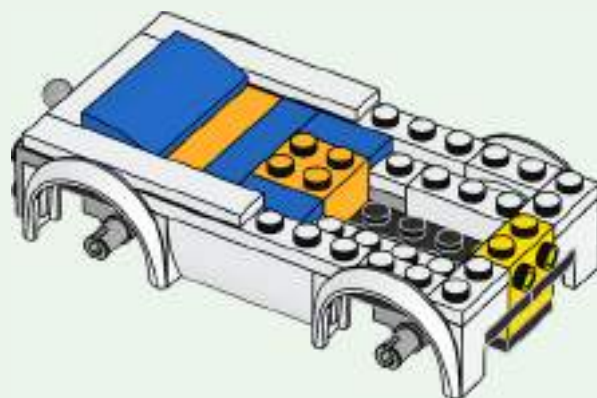

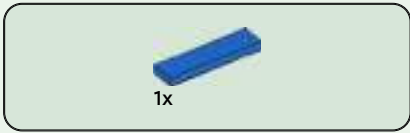

21

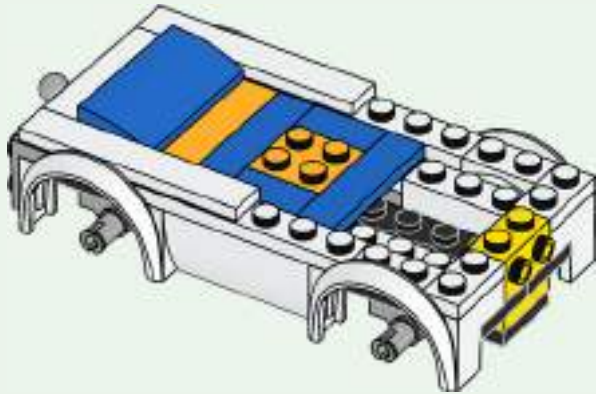

22

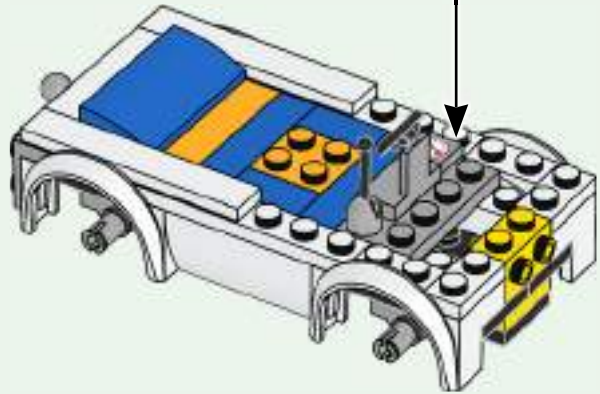
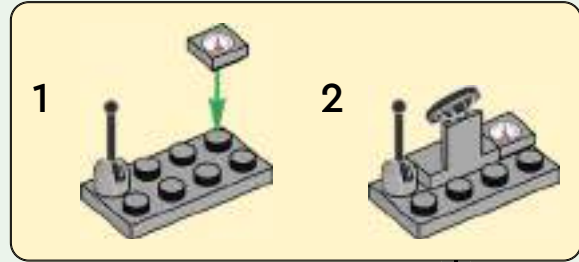



23

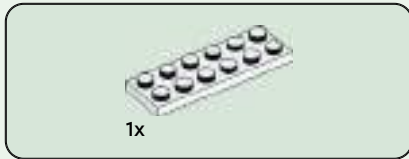
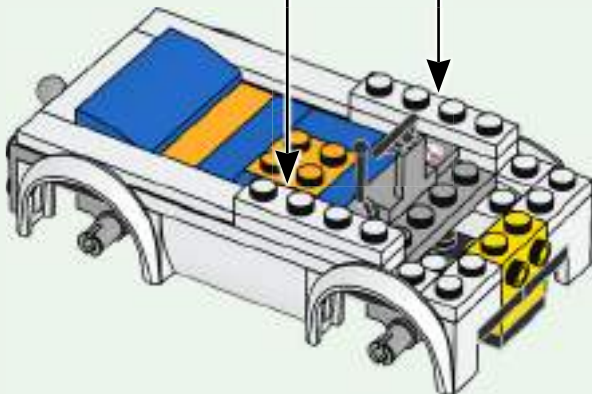
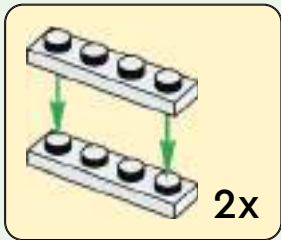

24



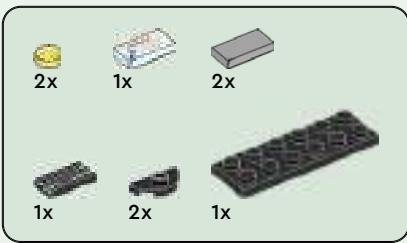

# 25







2x



2x

# 26

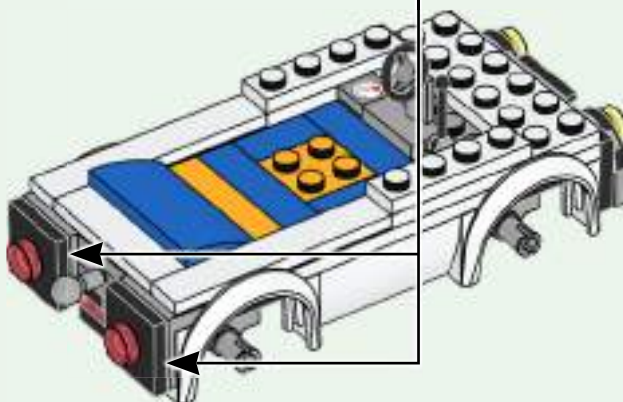



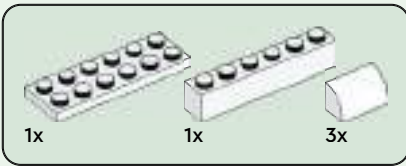

27

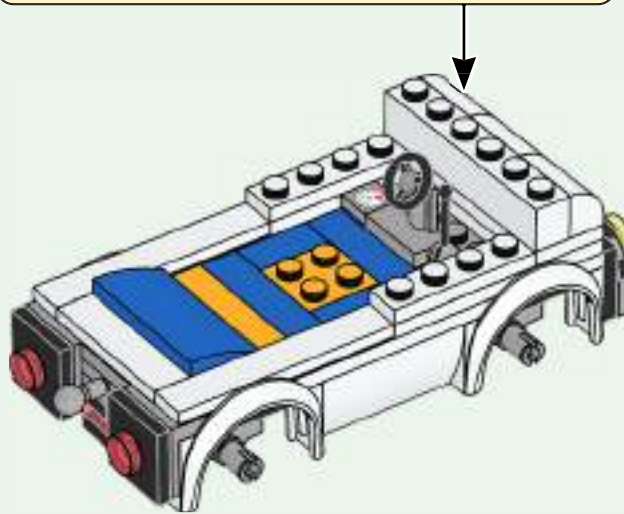
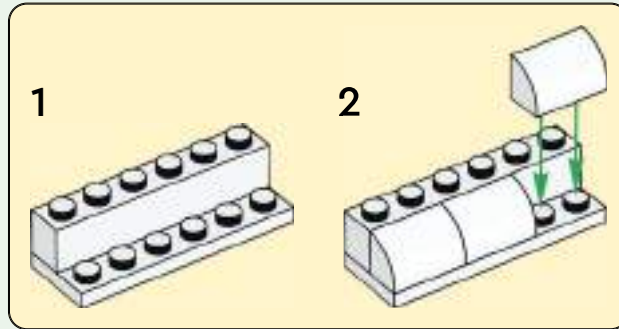



2x

28

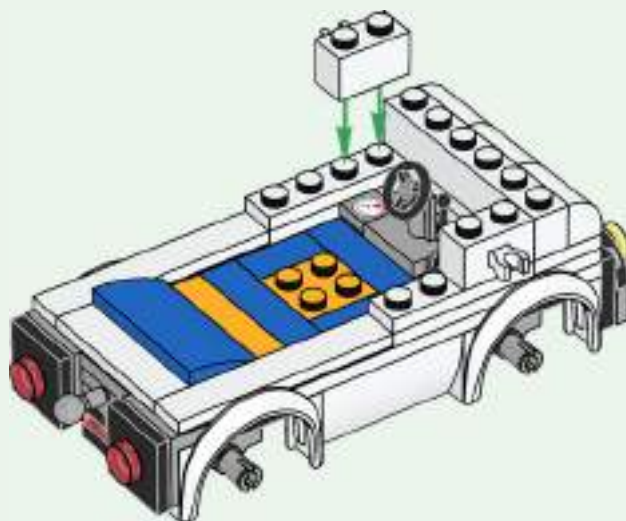



29

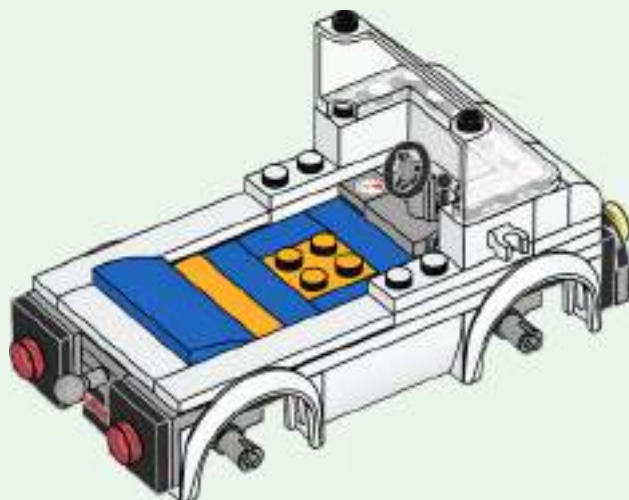

30

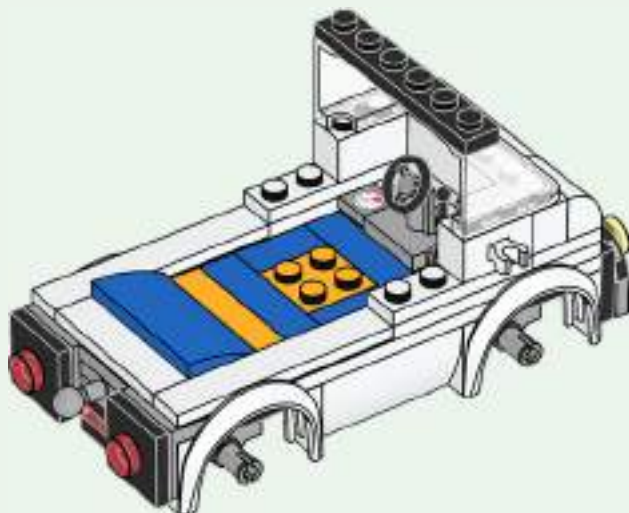



1x

31



1x

32

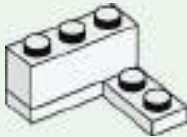



1x

33

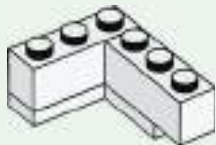

1x

34

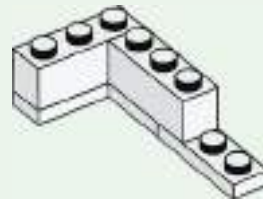



35

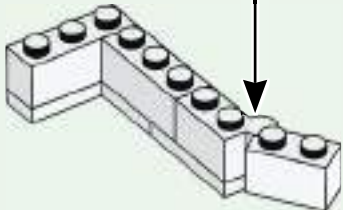
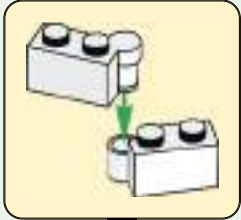

36

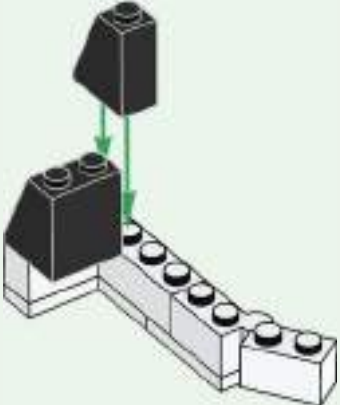





37

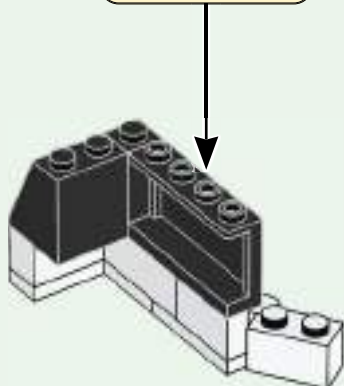

38

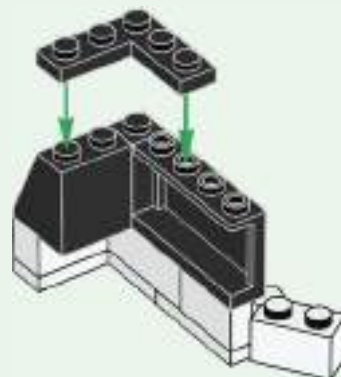



1x

39

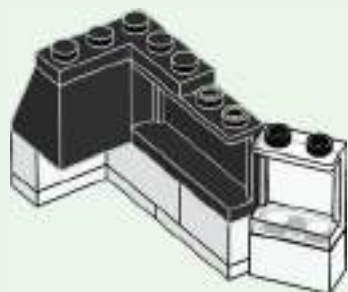

1x

40

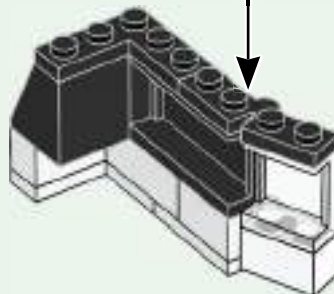

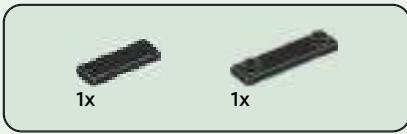

41

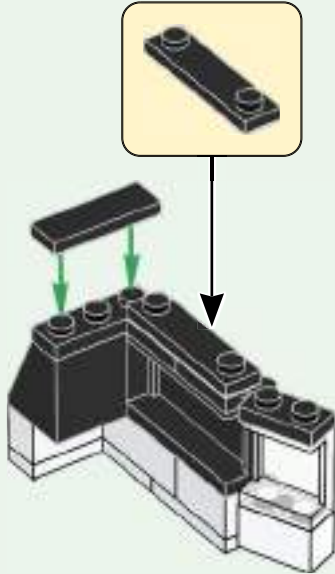

42

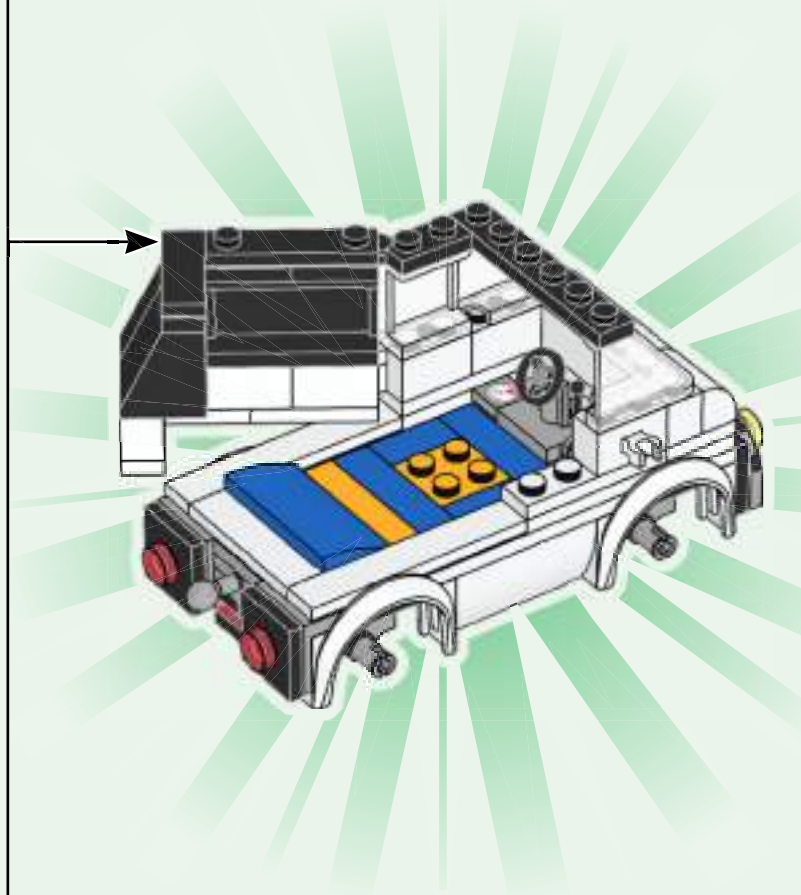



1x

43



1x

44

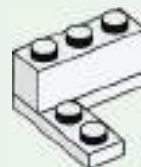

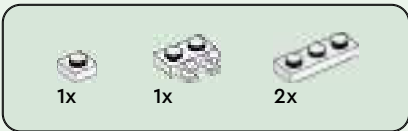

45

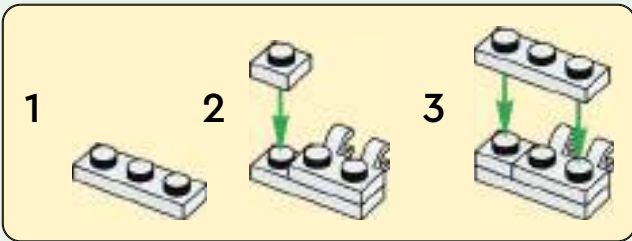

46

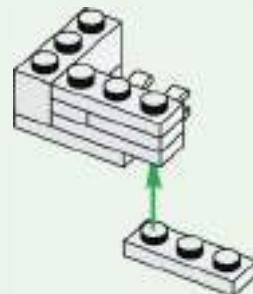



47

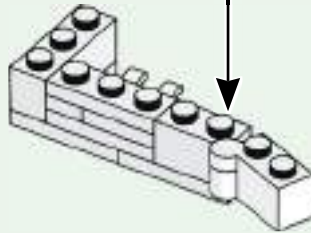
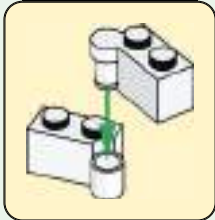

48

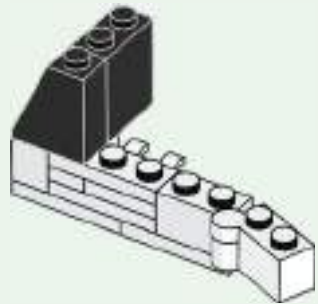



49



50

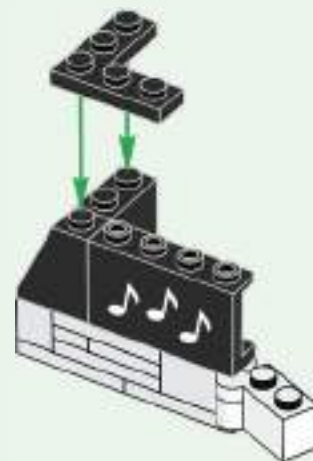



1x

51



1x

52

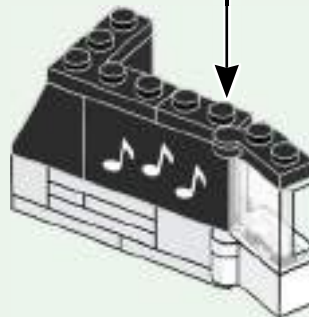



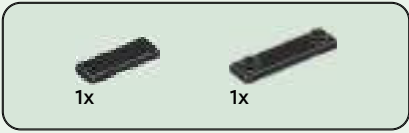

53

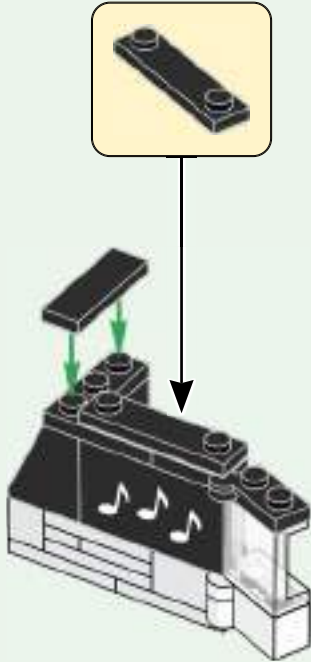

54

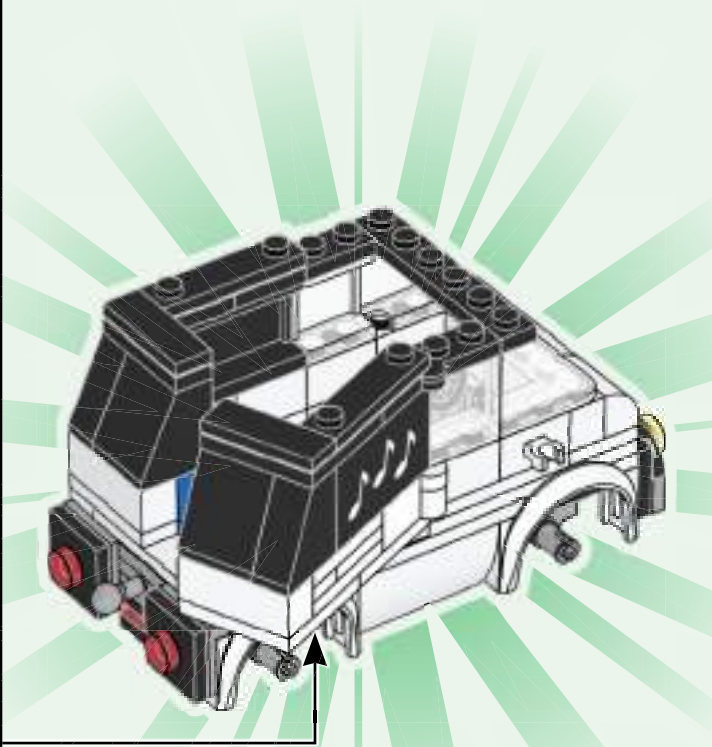



2x

55



2x

56

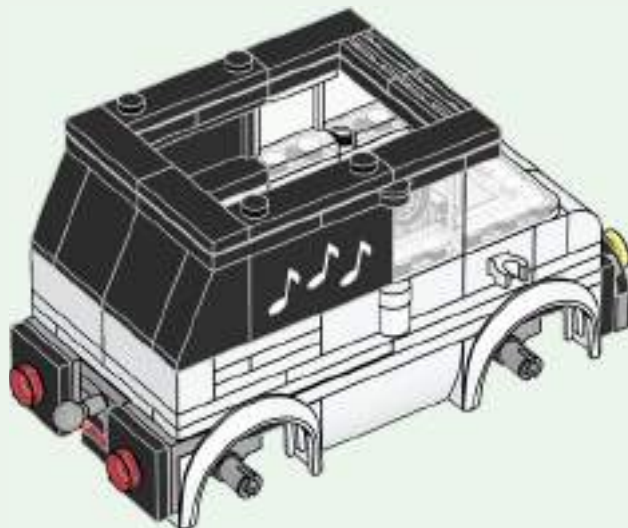



2x

57



2x

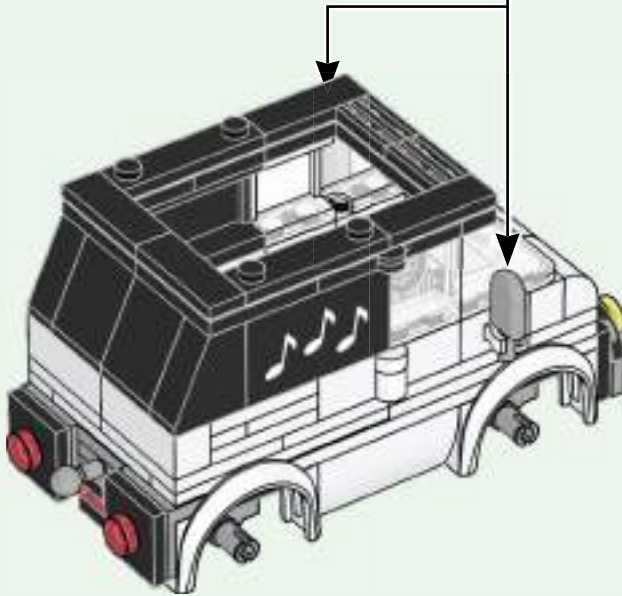

1x



1x



1x

58

1



2

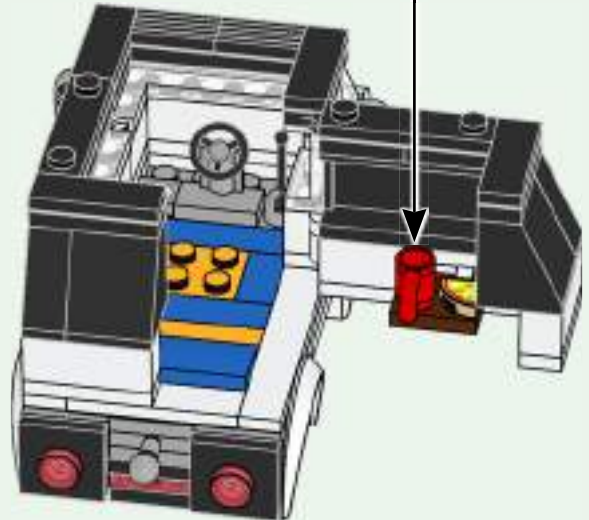

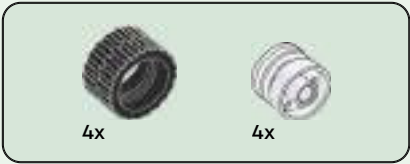

59

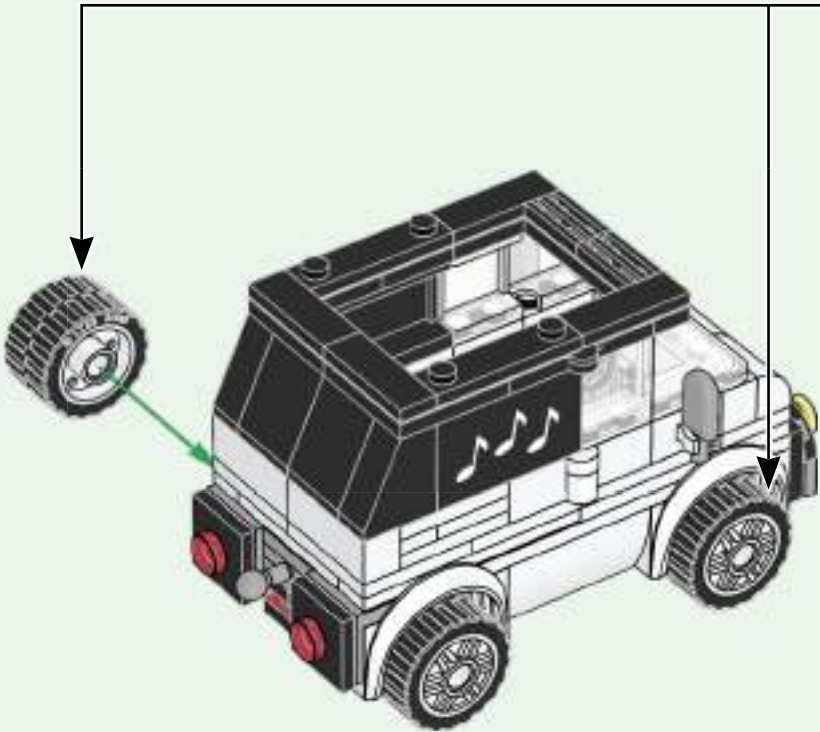
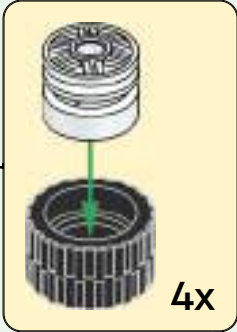

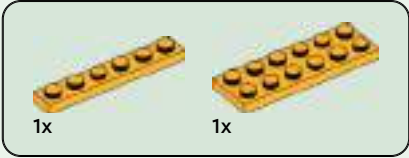

60

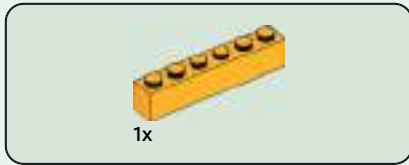
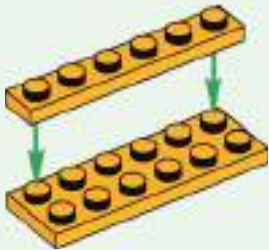

61

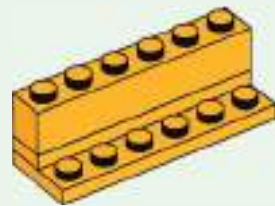



3x

62

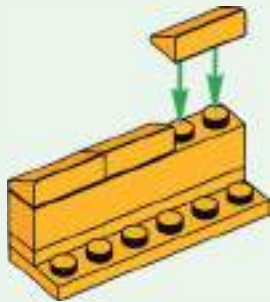

1x

63



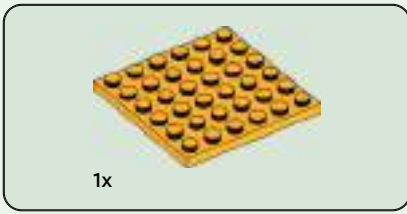

64

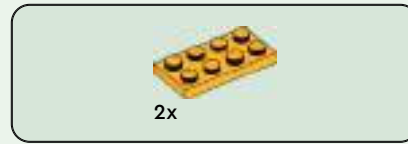
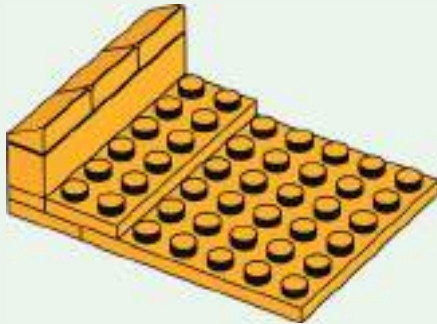

65

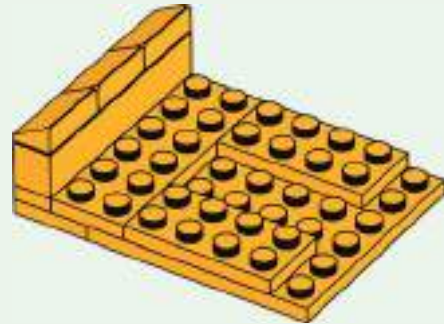



3x

66

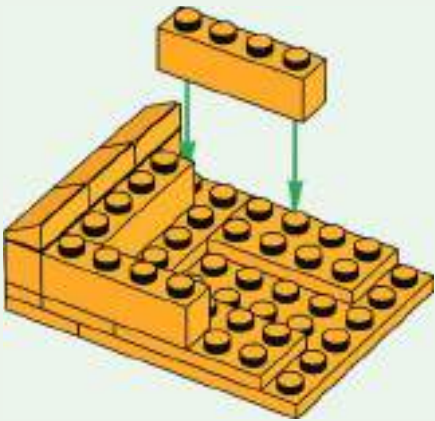

1x

67

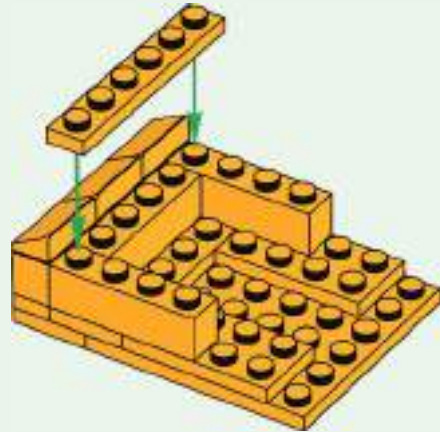





68

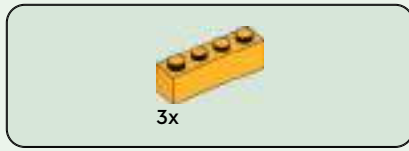
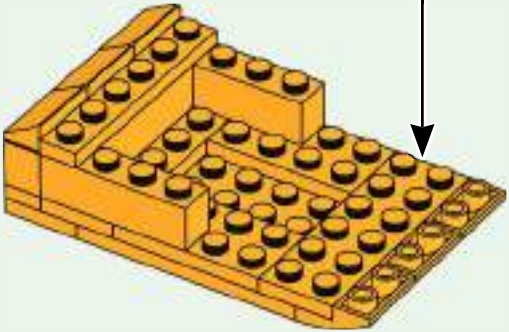
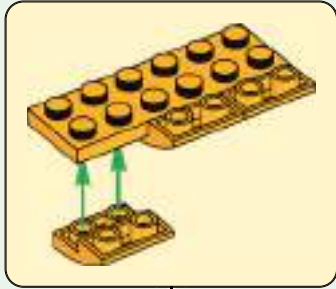

69

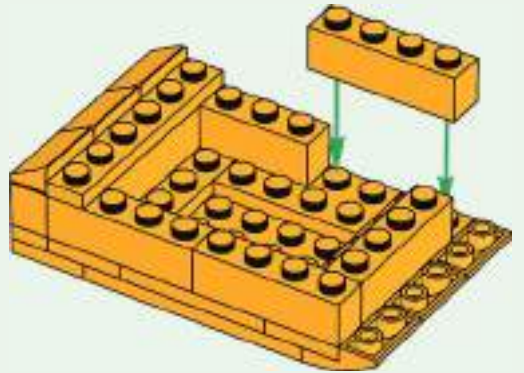

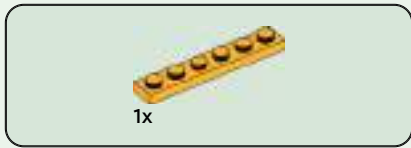

70

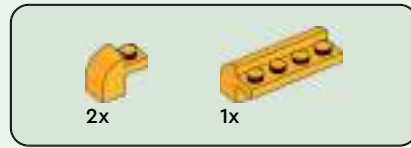
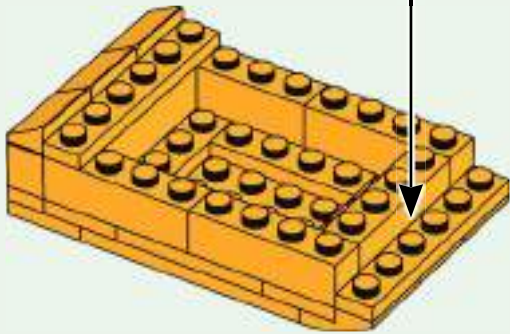
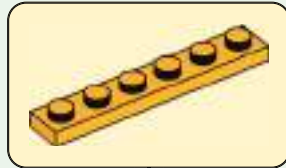

71

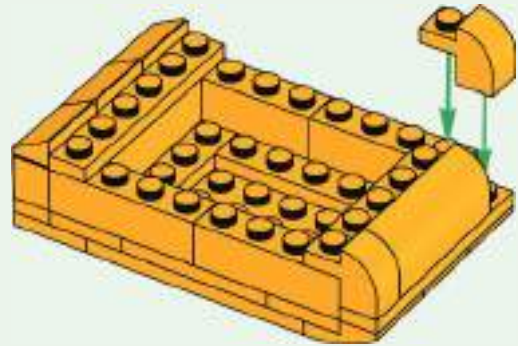

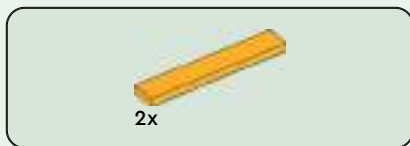

72

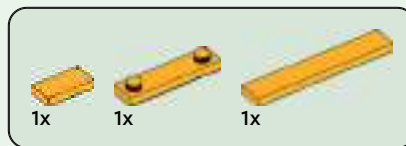
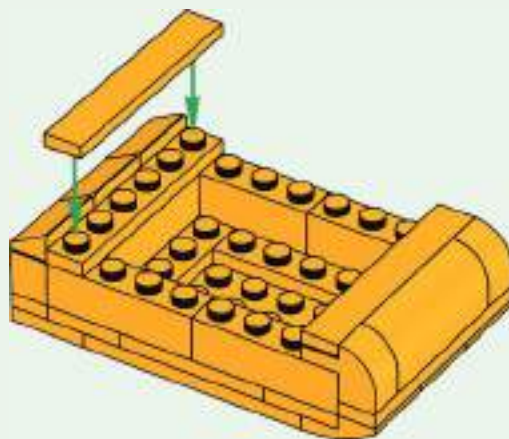

73

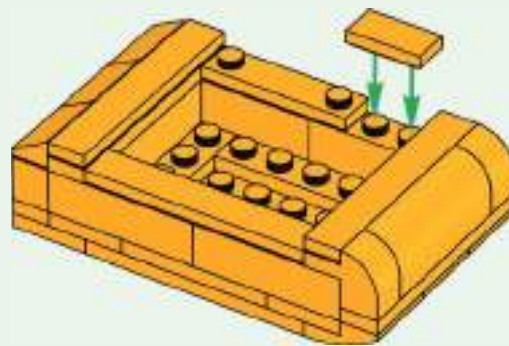

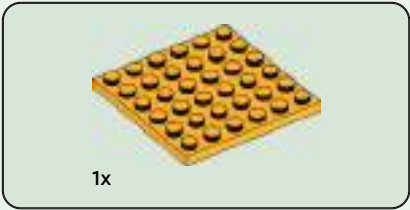

74

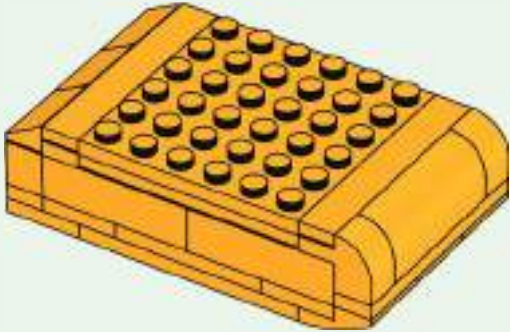

75



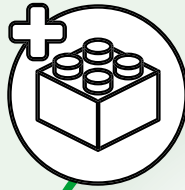

1x



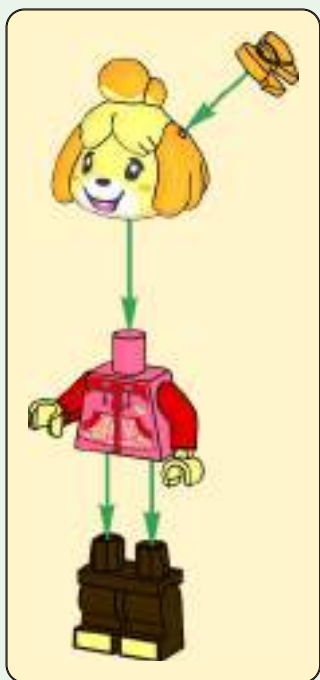



2x

1

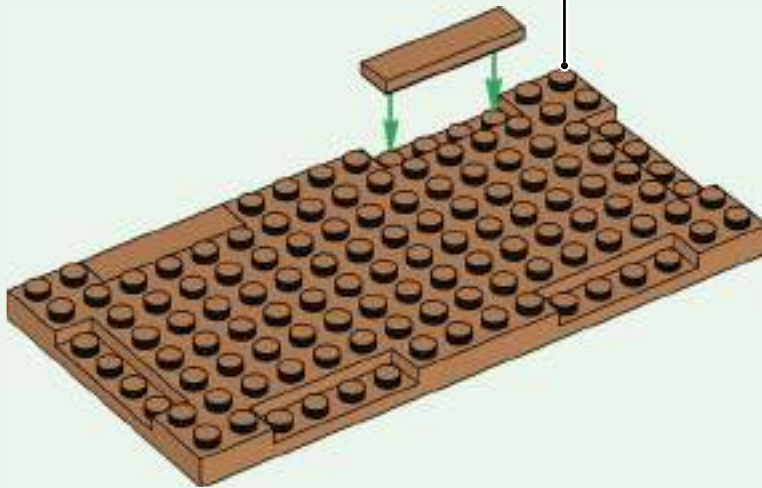
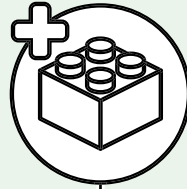



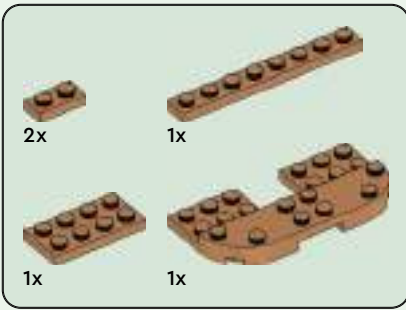

2

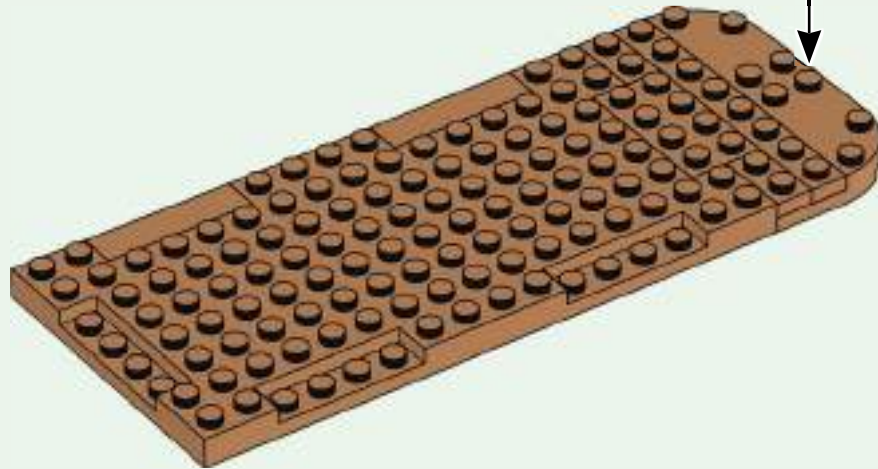
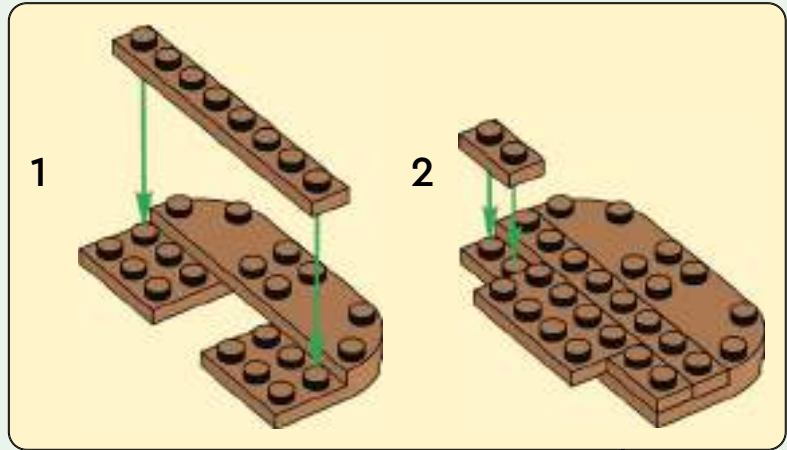

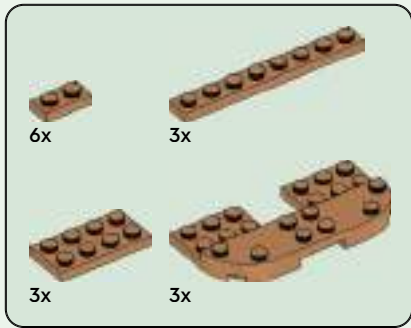

3

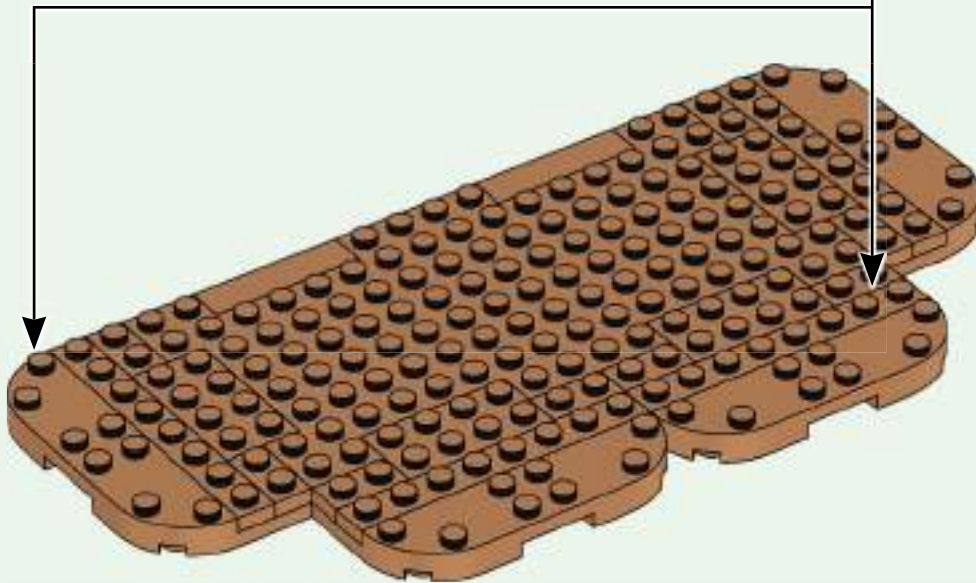
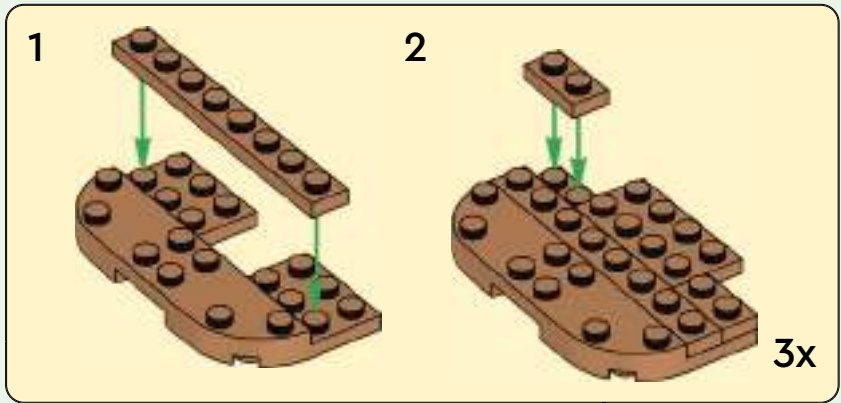



1x

4

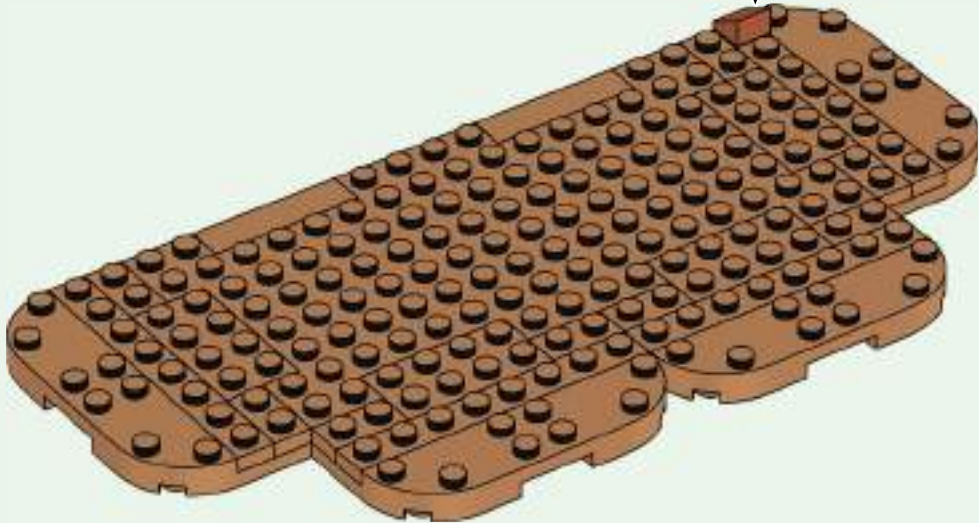



3x

5

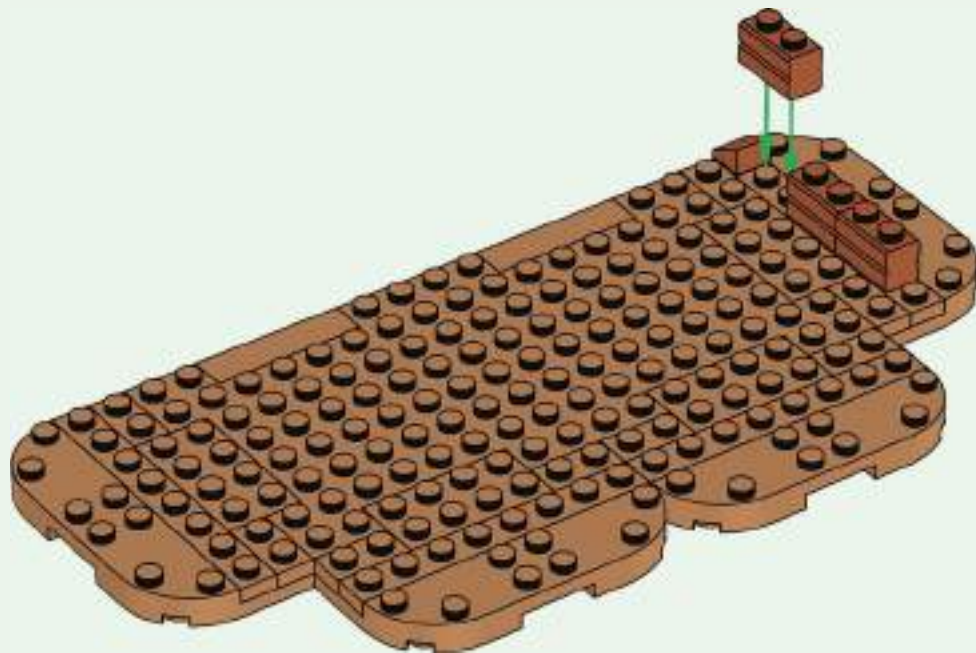



2x

6

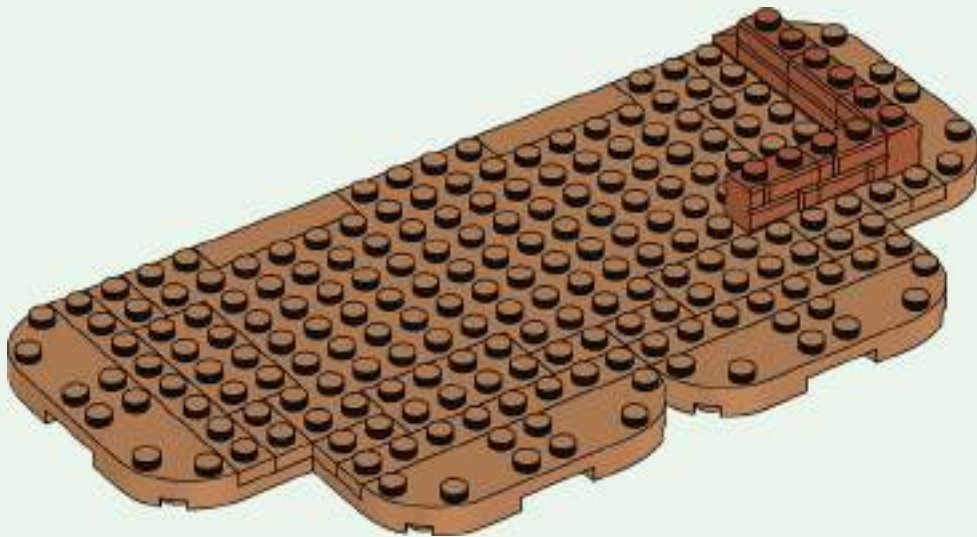



1x

7

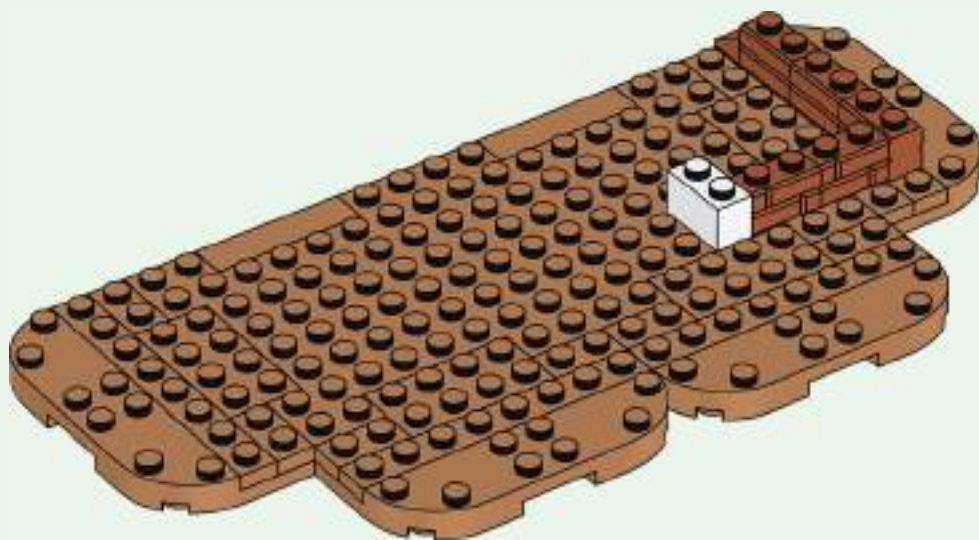



1x

8

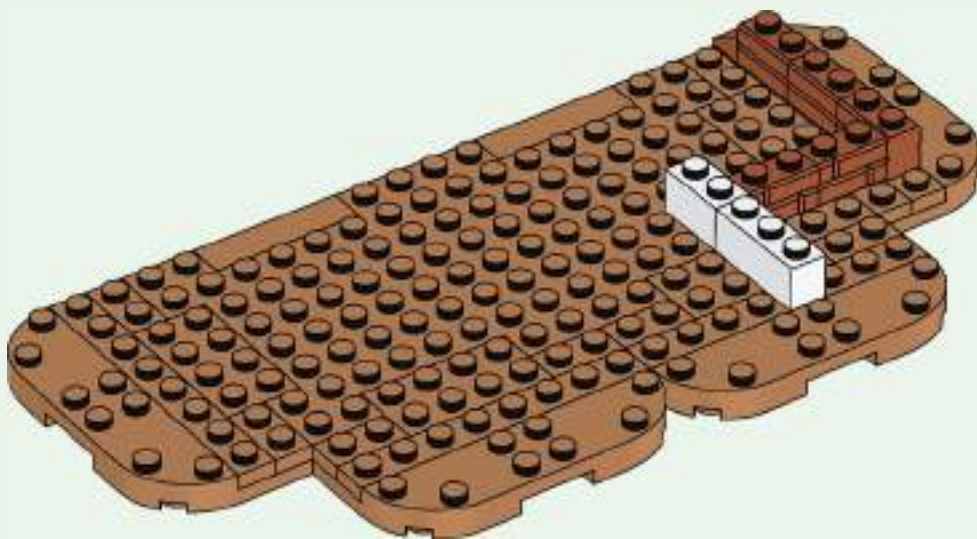

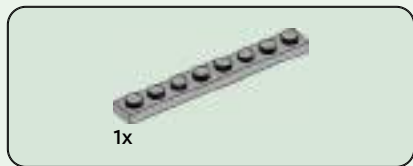

9

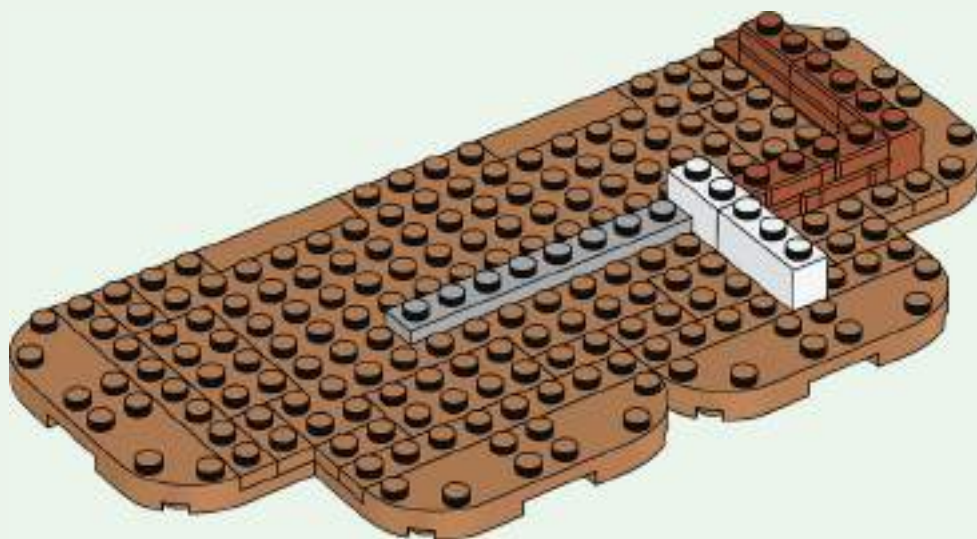



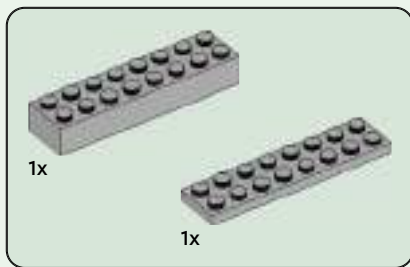

10

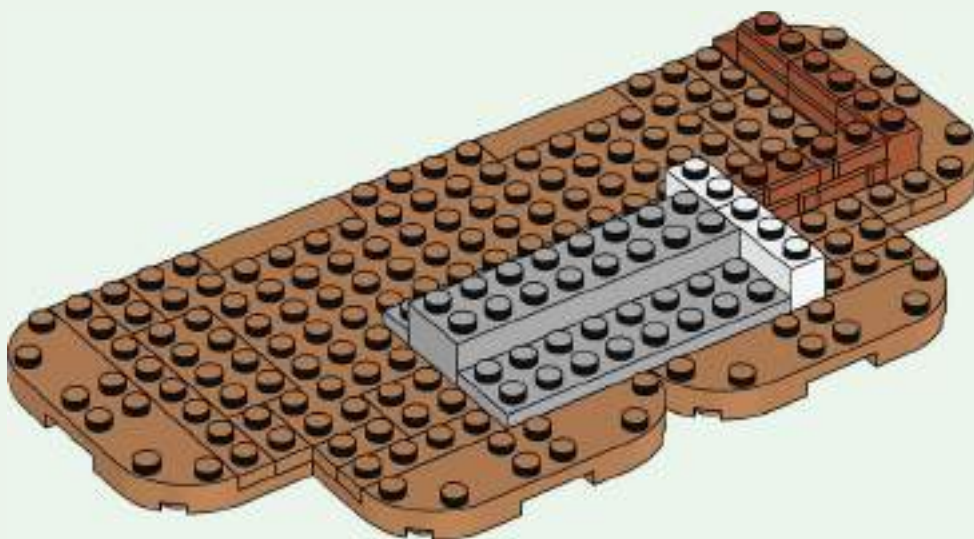



1x



1x

11

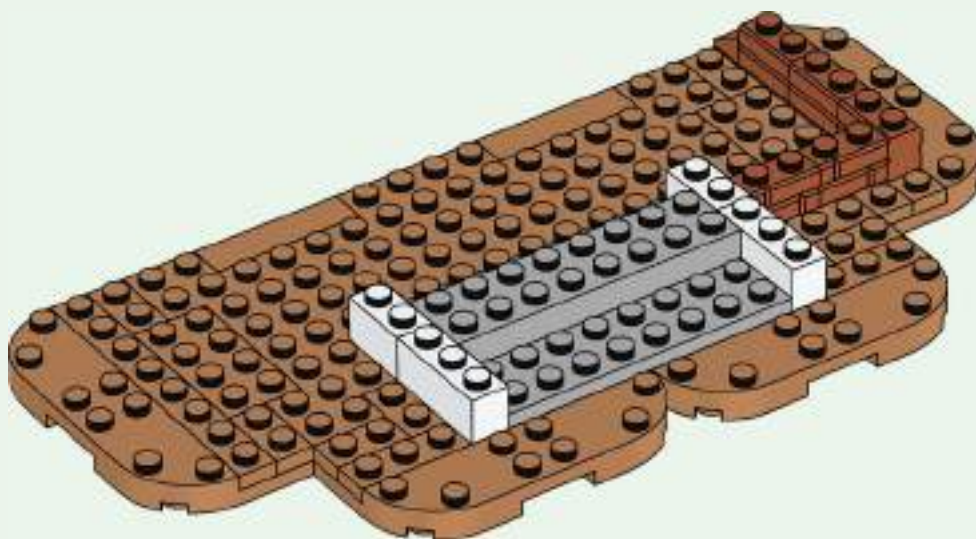



1x



5x

# 12

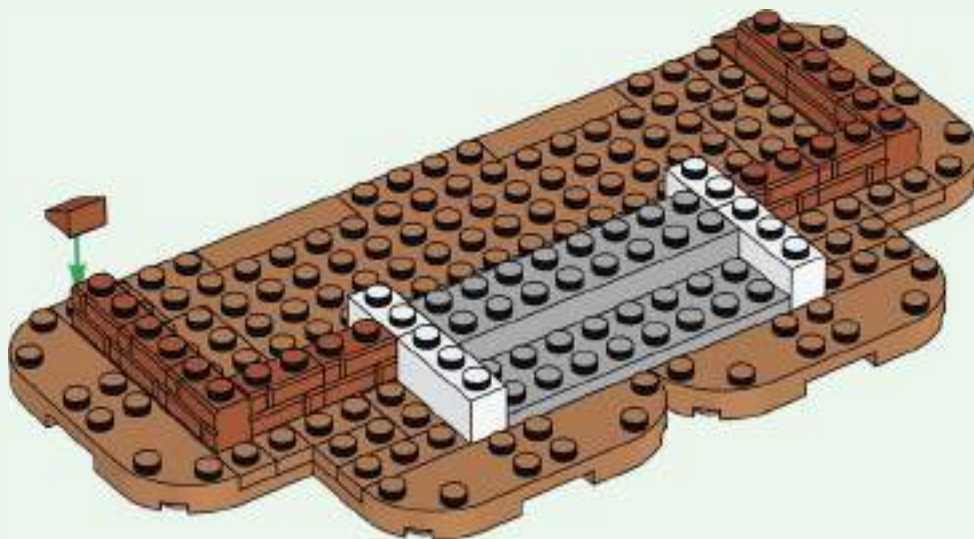



6x

13

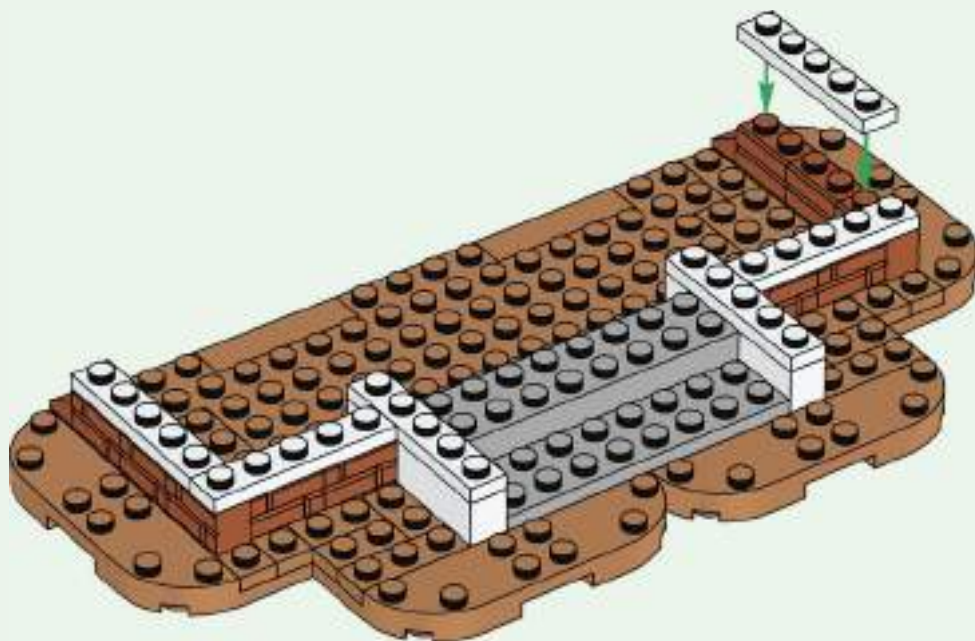

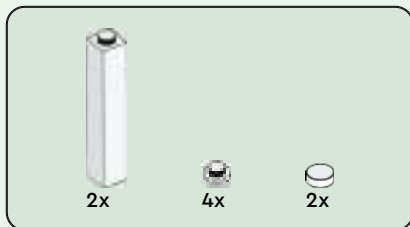

14

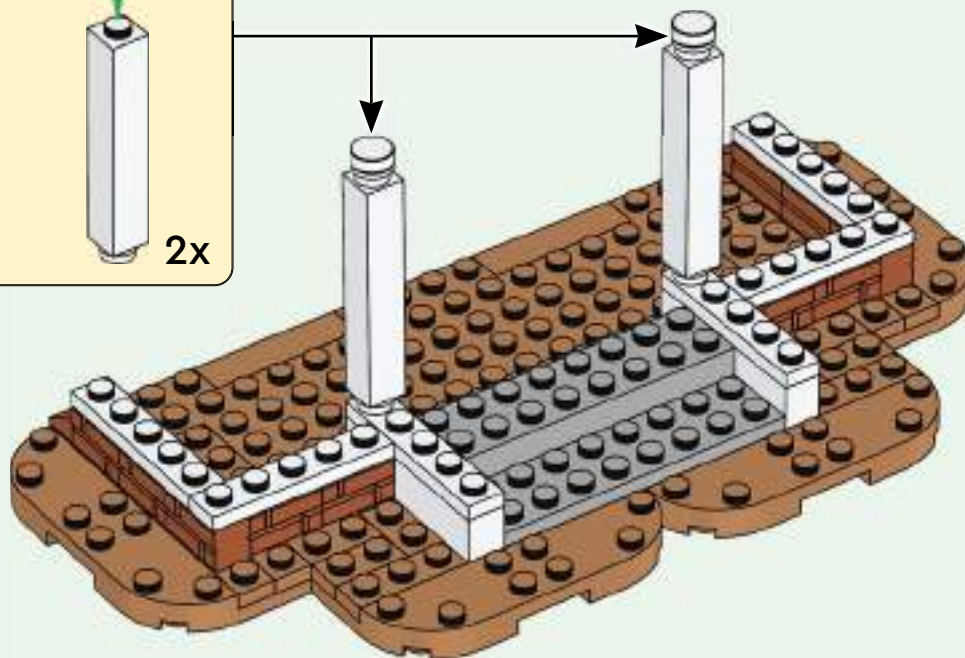
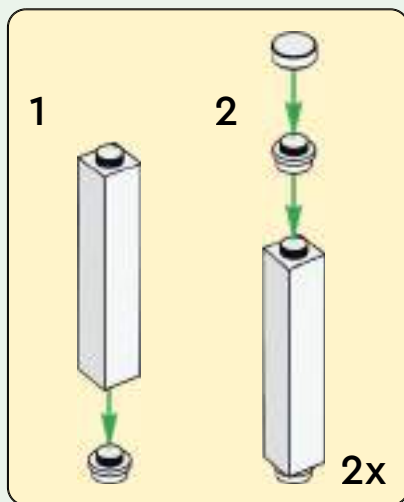

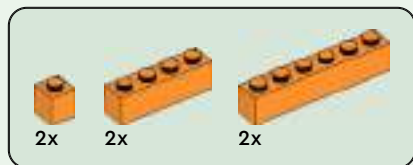

15

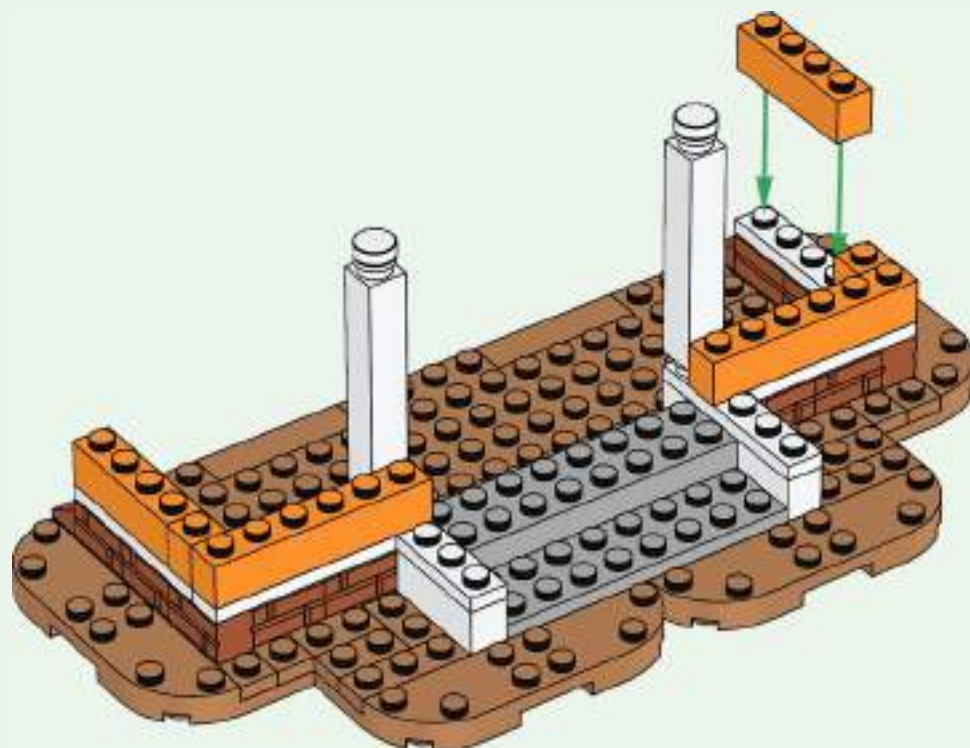

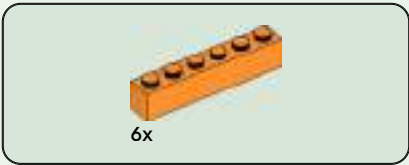

16

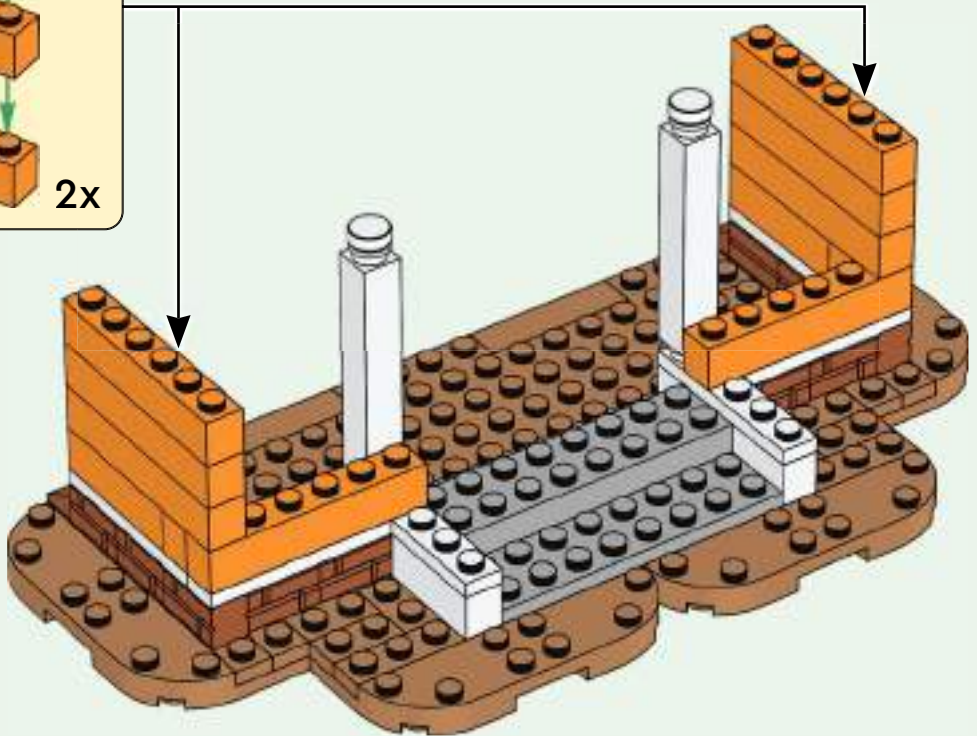
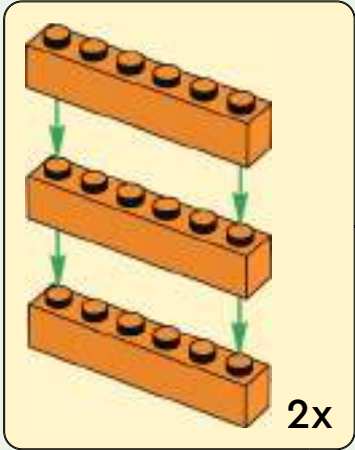

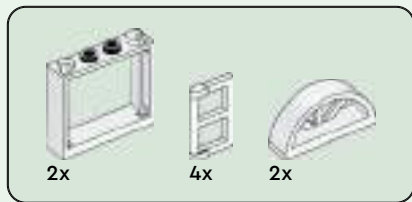

17

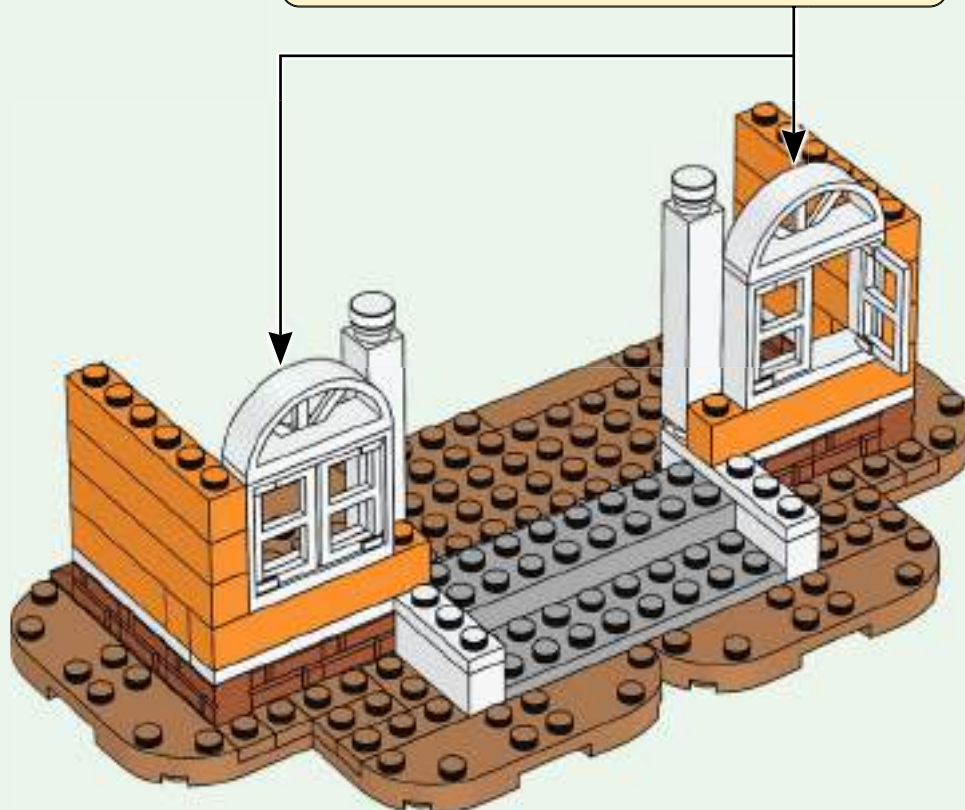
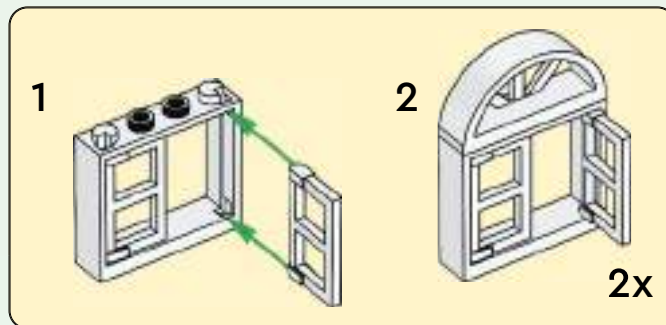





6x

18



2x

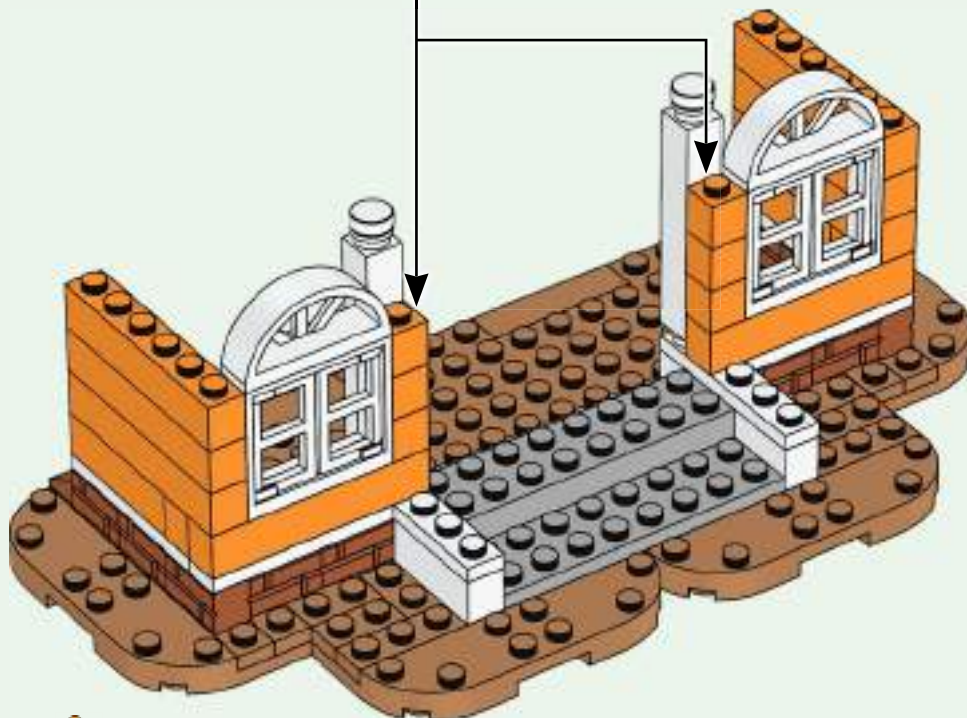



19

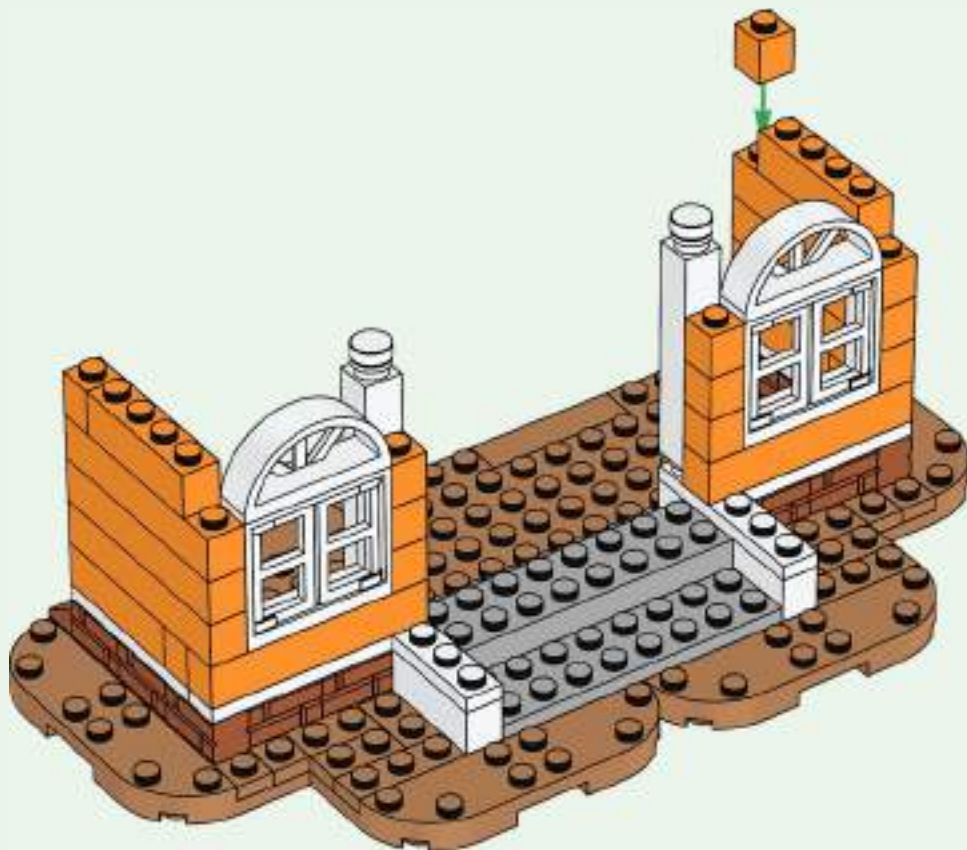

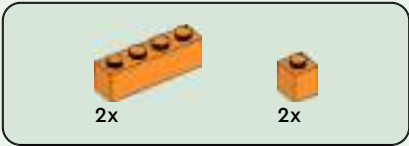

20

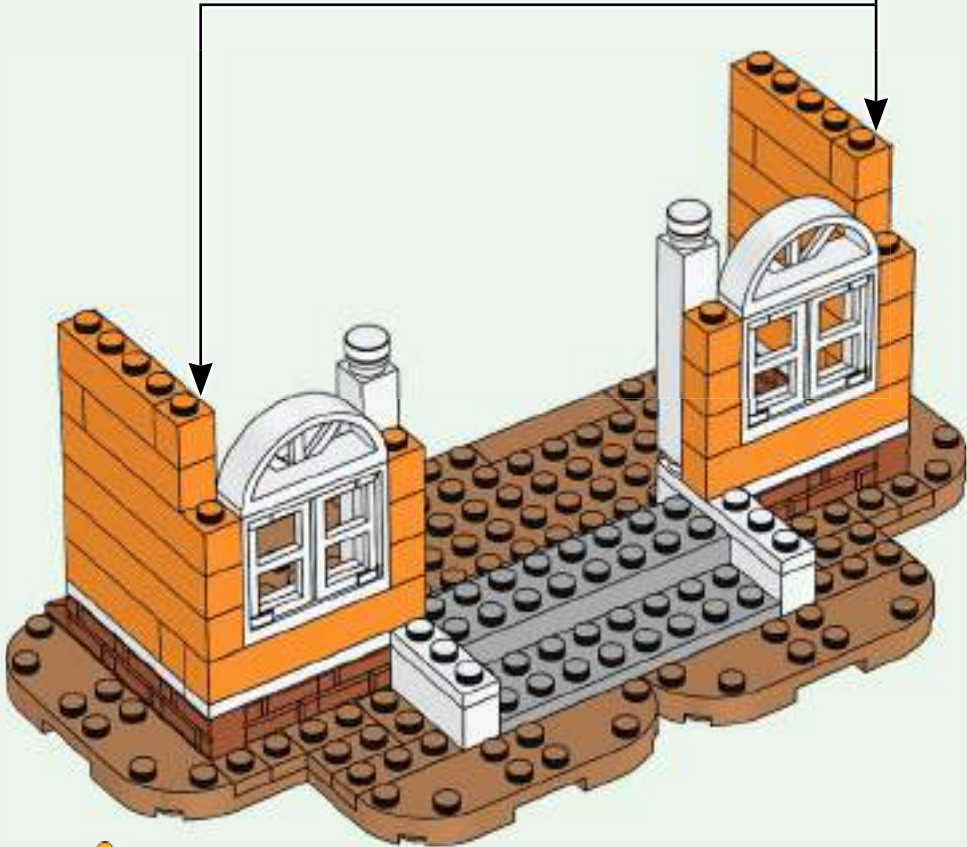
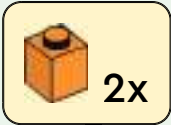



2x

21



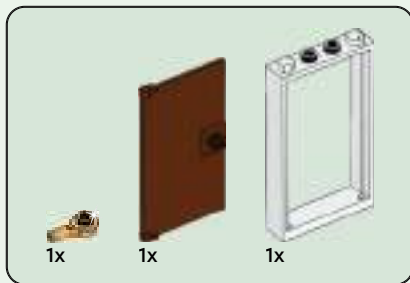

22

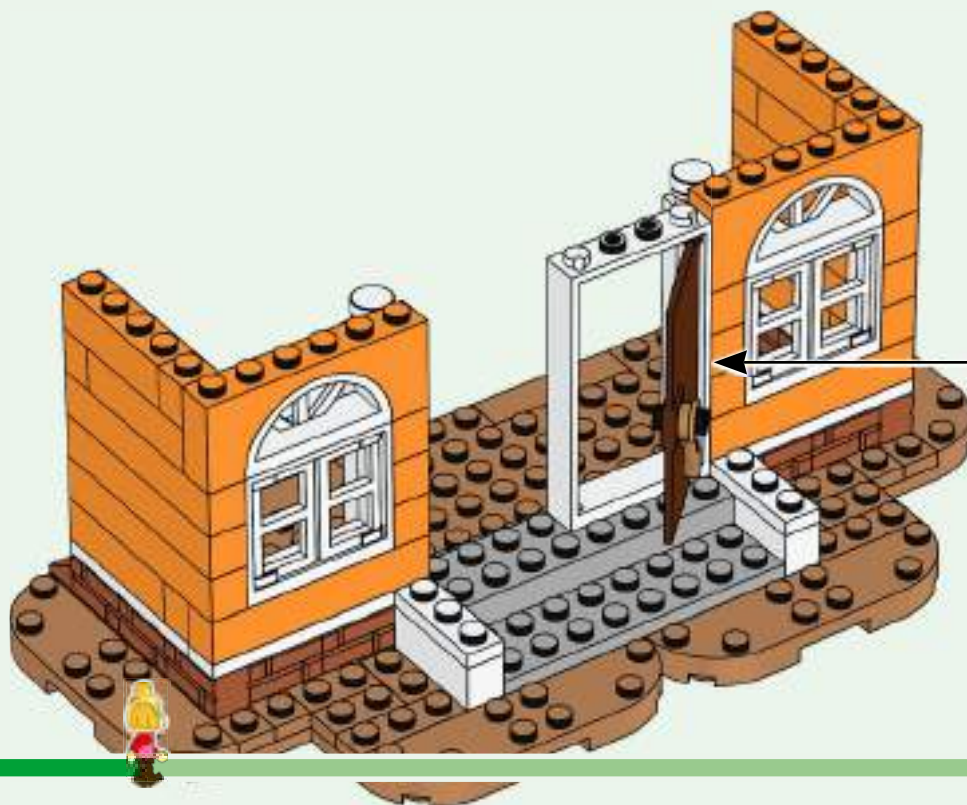
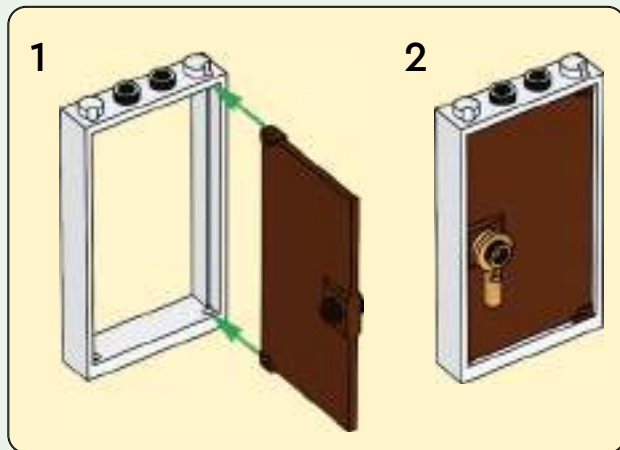

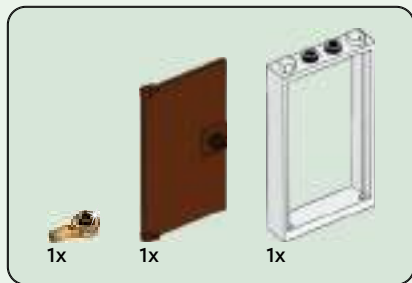

23

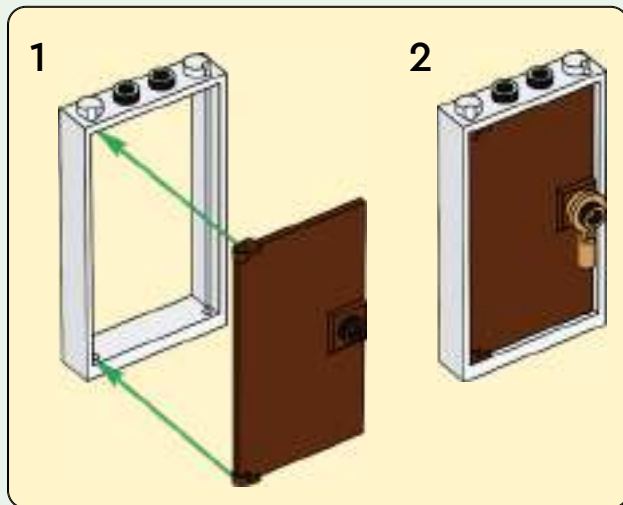

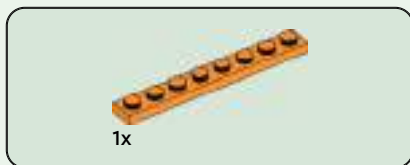

24





4x

25



4x

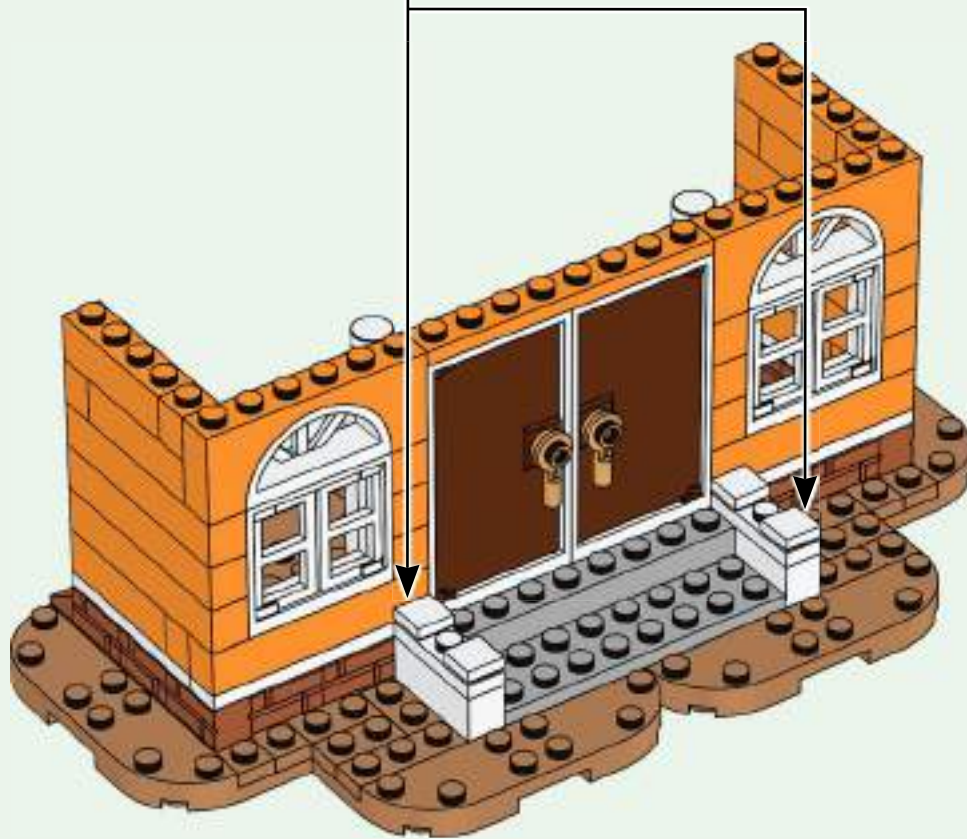





26



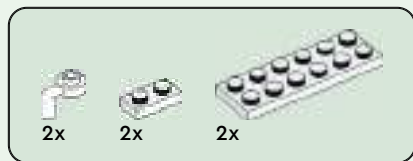

27



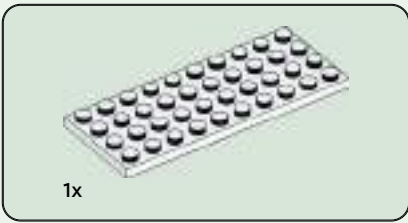

28



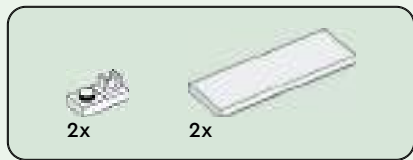

29





2x



1x

30







4x

31





4x

32







2x



1x



2x

33

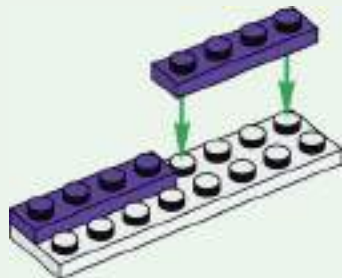

1x

34



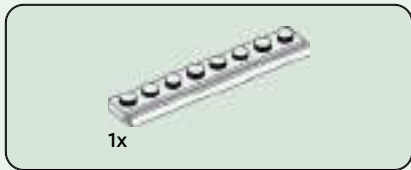

35



36

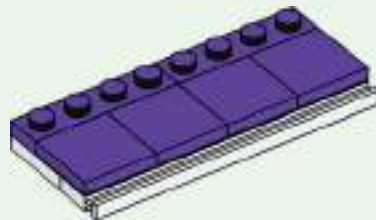



4x

37

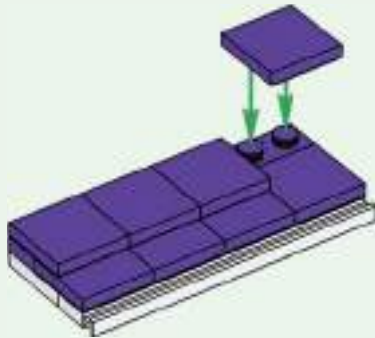

2x

38

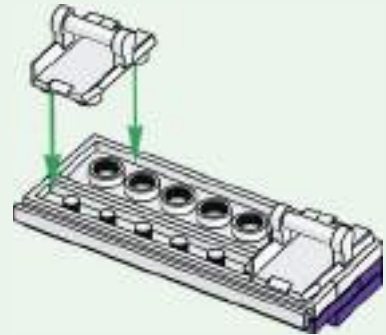

2x



39





40

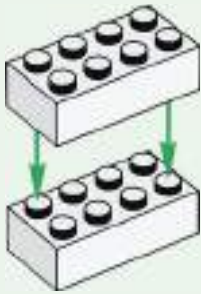

41

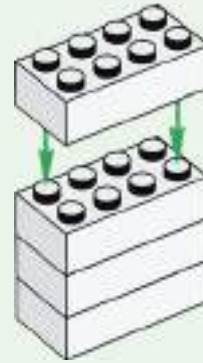



42

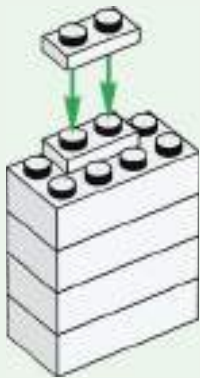

43

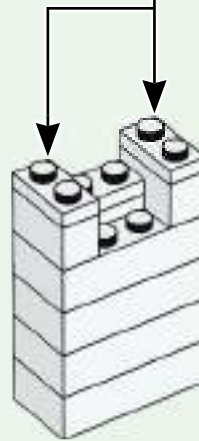
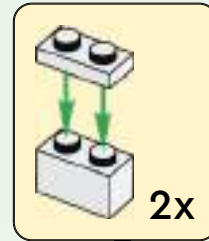



44

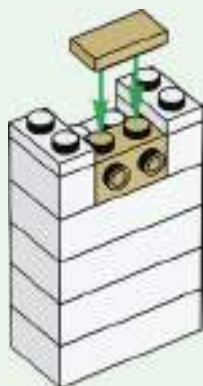

45





1x

46



2x

47







2x

48



49



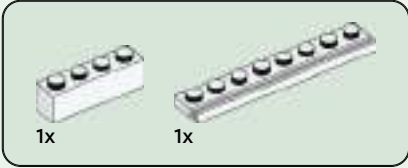

50

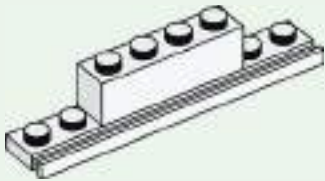

2x

51

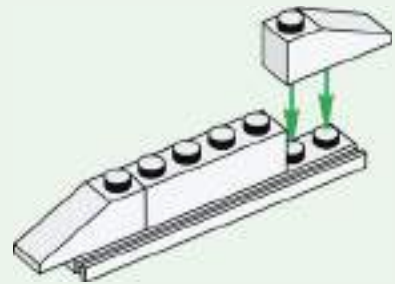



2x

52

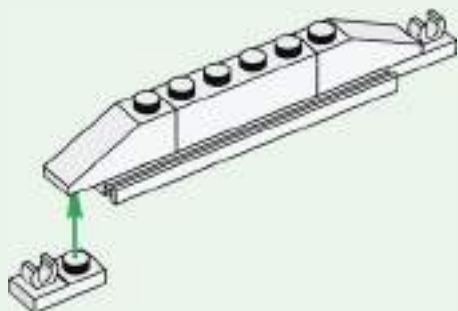

2x

53

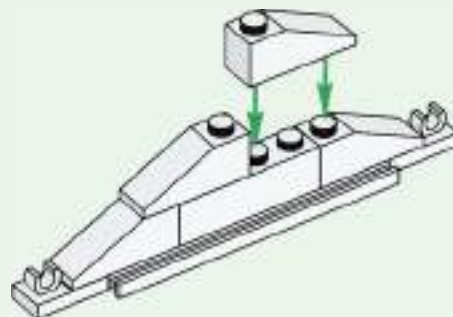



2x

54

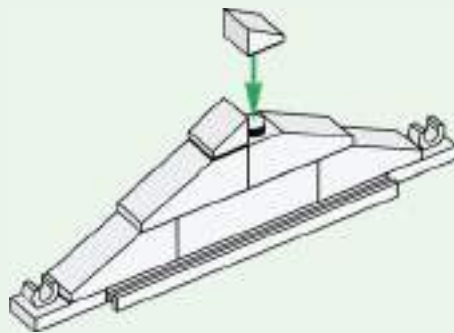



55

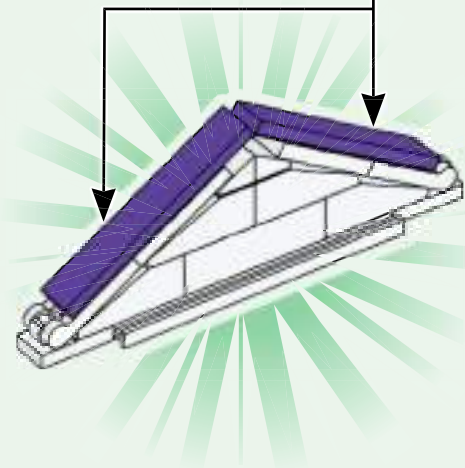
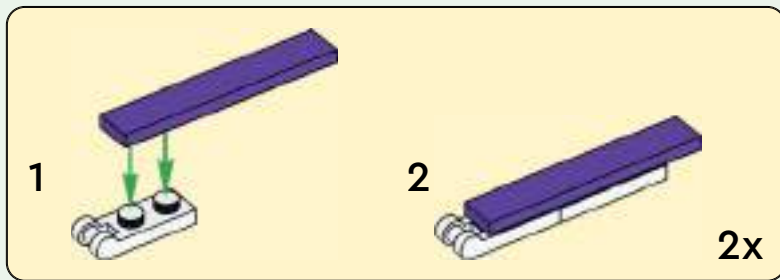

56









57

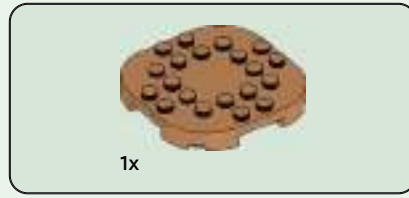
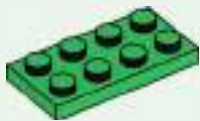

58



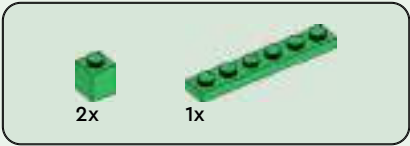

59

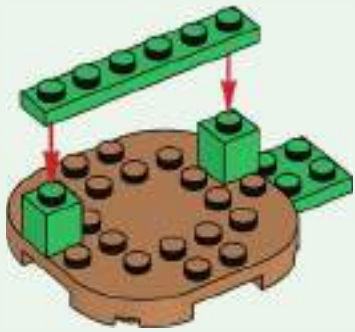

60

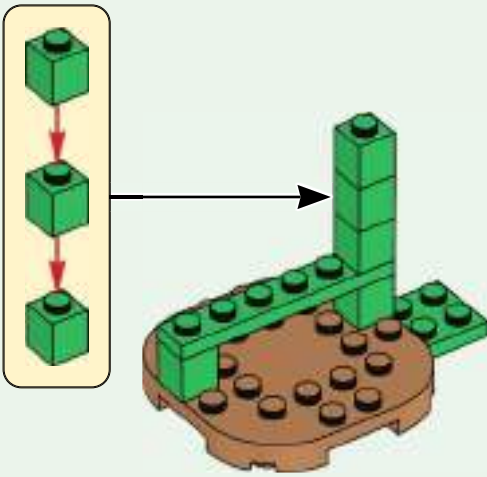



61

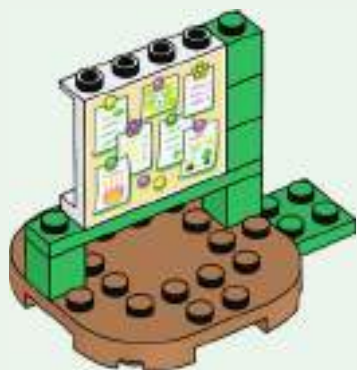

62

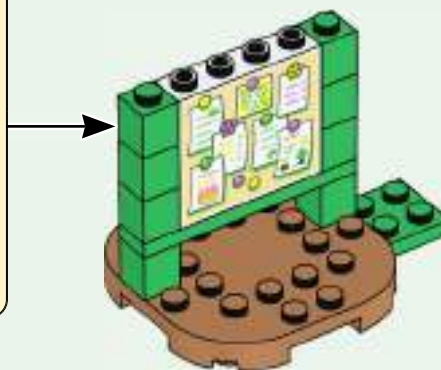

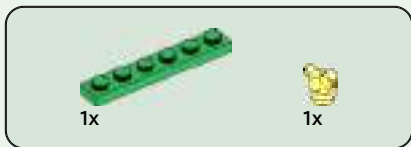

63



64





1x



1x



1x

65





1x

66





67



68







1x

69



1x



1x

70





1x

71



2x

72



1x

73

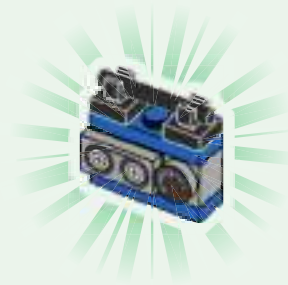

74





75

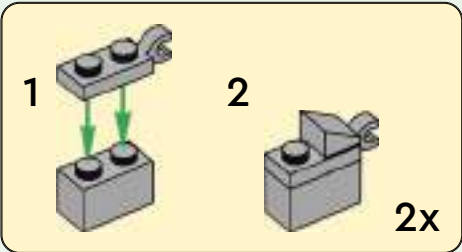

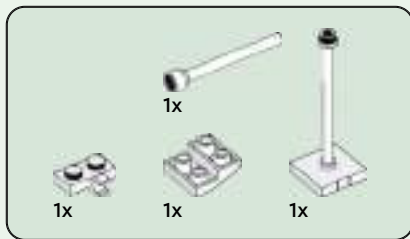

76

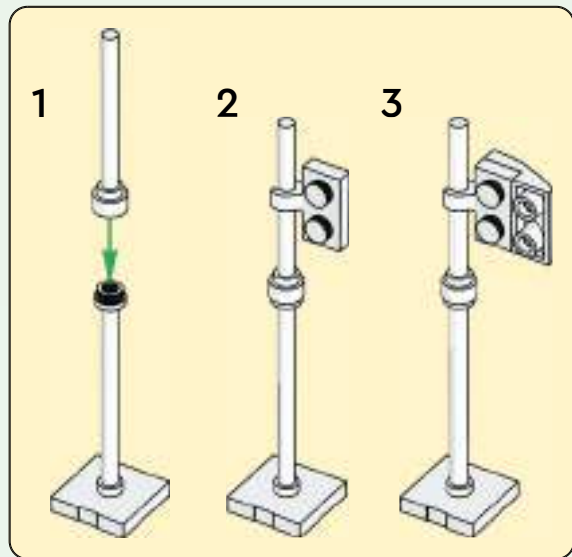
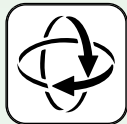



77





78

1



2



3



4



79







1x



1x

80



1x

81

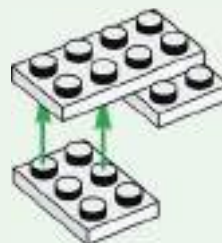



1x

82



1x

83

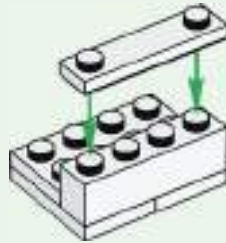



2x

84

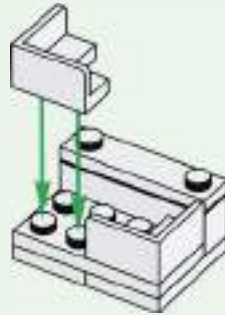

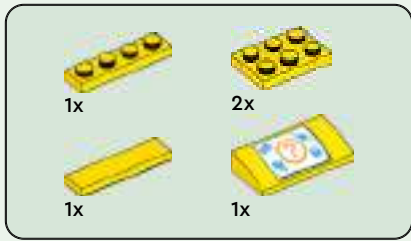

85

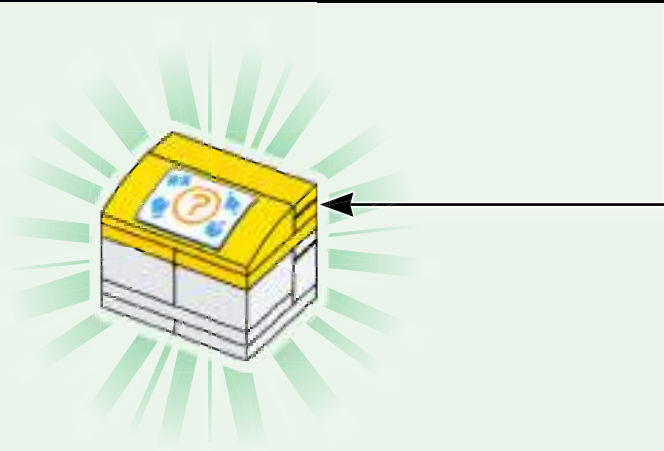
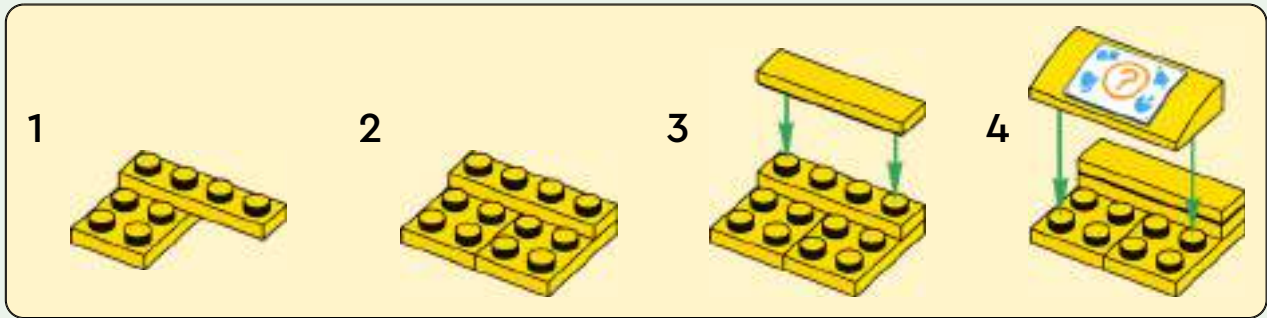

86





87

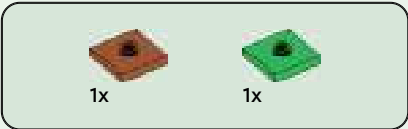

88





1x

89



1x



1x



1x



1x

90

1



2



3



4



91







1x



1x

92



1x

93



1x

94



1x

95





1x

96



1x

97



1x

98



99



100

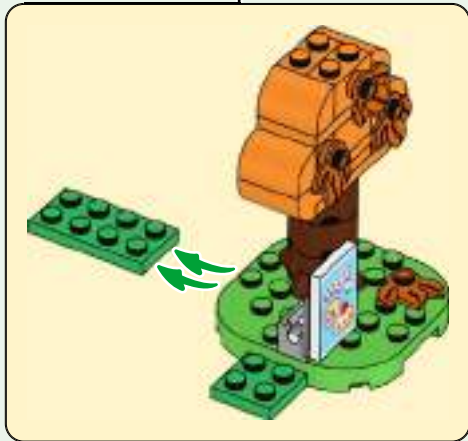
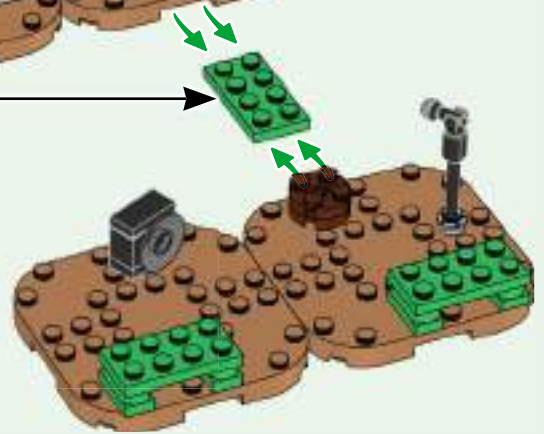







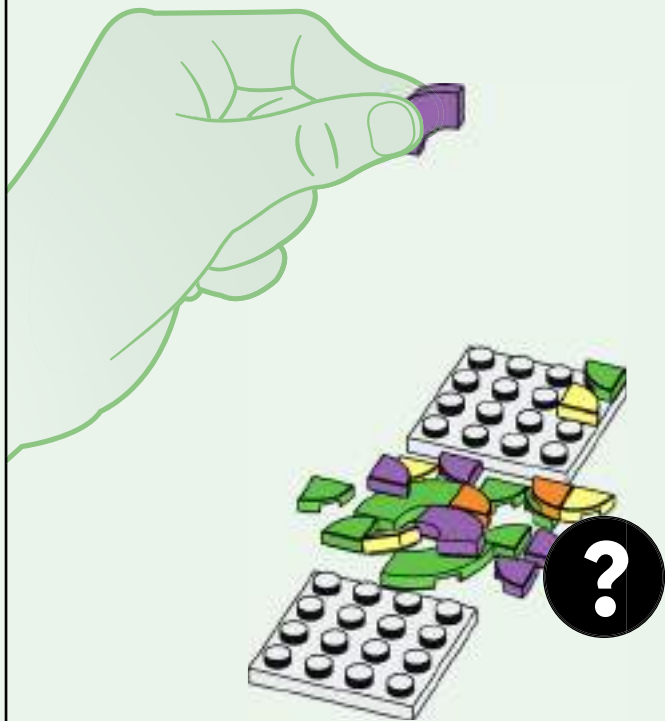
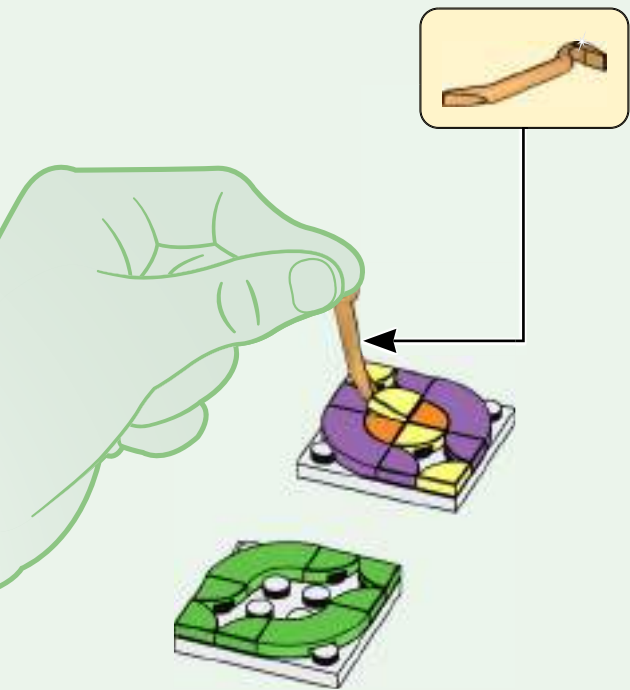



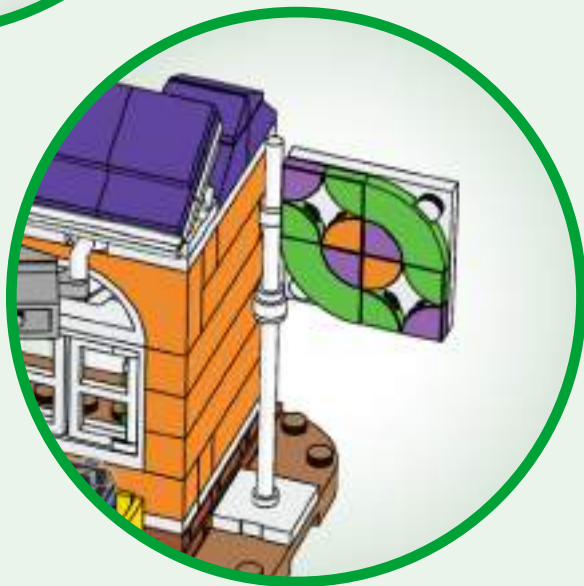
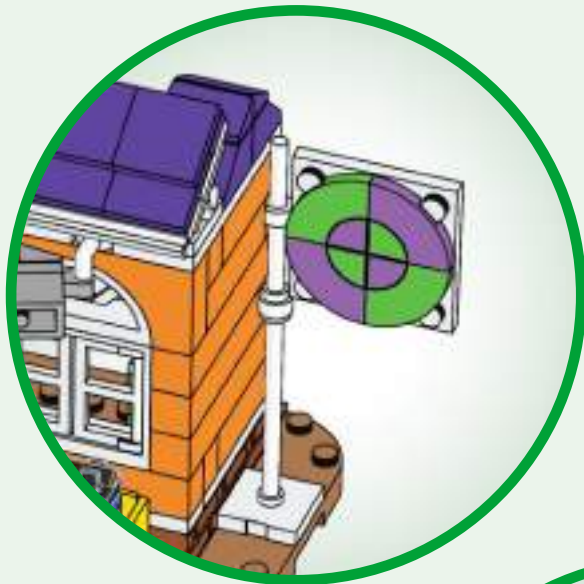



# Welcome to Animal Crossing





77052



77051



77047



77049



77050



 4x  
614101

 2x  
6284572

 1x  
6438901

 1x  
302401

 2x  
6235083

 2x  
6073345

 4x  
307001

 2x  
4504369

 2x  
245301

 4x  
6171058

 1x  
6132824

 2x  
6508268

 2x  
403201

 2x  
6489694

 1x  
6284507

 1x  
6270843

 1x  
287701

 2x  
6320300

 10x  
302301

 3x  
6248827

 1x  
6489719

 2x  
6327411

 6x  
6347309

 4x  
300401

 1x  
6469573

 1x  
6313115

 4x  
6117940

 1x  
6347287

 2x  
383101

 1x  
6489714

 1x  
6469556

 1x  
4612342

 1x  
6329696

 1x  
306801

 1x  
6170709

 2x  
6181753

 4x  
6260609

 1x  
6210385

 2x  
4515364

 1x  
6489722

 5x  
362201

 6x  
362301

 4x  
428601

 1x  
6509726

 4x  
6188400

 1x  
6489721

 2x  
302101

 1x  
6170504

 4x  
371001

 1x  
243101

 2x  
301001

 1x  
6249091

 2x  
4530590

 2x  
6173064

 1x  
6489720

 2x  
6262945

 2x  
6428165

 2x  
395701

 2x  
4583297

 2x  
302001

 4x  
300101

 4x  
6438923

6x  
6350399

2x  
366601

2x  
663601

1x  
300901

2x  
4243812

4x  
379501

2x  
6332042

3x  
4501853

2x  
303401

1x  
4503008

1x  
6287774

1x  
6361753

1x  
4529237

1x  
6463667

1x  
6422004

2x  
6387150

1x  
6024495

1x  
4114026

1x  
4565387

2x  
6469454

1x  
6302268

2x  
4243824

1x  
6100565

1x  
389921

1x  
302021

2x  
306923

2x  
362323

2x  
243123

1x  
4651237

1x  
6119197

1x  
302324

2x  
302124

1x  
371024

1x  
243124

1x  
6489724

1x  
4599378

1x  
6327722

1x  
6315887

1x  
6168646

2x  
6335388

2x  
6510061

3x  
241226

1x  
4226995

2x  
4515373

1x  
306926

1x  
370026

1x  
302326

2x  
6093525

2x  
4565323

2x  
4273703

4x  
4558170

4x  
6132299

2x  
6489725

2x  
6254045

2x  
6439175

2x  
6416444

1x  
366626

1x  
379526

3x  
244526

8x  
300528













4x  
6210271















4x  
302328

1x  
6389692

6x  
302028

2x  
366628

  
 1x  
 6206150  
  
 6x  
 6275873  
  
 2x  
 6235080  
  
 1x  
 6343326  
  
 1x  
 6442896  
  
 2x  
 6382958  
  
 1x  
 6469464  
  
 1x  
 6301631  
  
 2x  
 6104342  
  
 10x  
 6314383  
  
 1x  
 6315197  
  
 2x  
 6253231

  
 1x  
 6503221  
  
 2x  
 6258607  
  
 1x  
 6276023  
  
 1x  
 6514003  
  
 2x  
 6274740  
  
 2x  
 6173925  
  
 2x  
 6431334  
  
 12x  
 4173805  
  
 1x  
 4121739  
  
 4x  
 6385785  
  
 1x  
 6504996  
  
 3x  
 6504995  
  
 2x  
 6442089  
  
 1x  
 4159007

  
 6x  
 4118827  
  
 3x  
 4158355  
  
 8x  
 4189007  
  
 2x  
 6337195  
  
 1x  
 6210229  
  
 1x  
 6240515  
  
 1x  
 6508761  
  
 1x  
 6276071  
  
 2x  
 6250601  
  
 2x  
 6069006  
  
 2x  
 4234716

  
 2x  
 4187743  
  
 1x  
 6096991  
  
 1x  
 6263103  
  
 3x  
 6024286  
  
 1x  
 4622062  
  
 2x  
 6174487  
  
 1x  
 6295078  
  
 3x  
 6492634  
  
 1x  
 6072668  
  
 6x  
 6003004  
  
 1x  
 6257595  
  
 2x  
 6097511  
  
 1x  
 6393827

  
 3x  
 6365966  
  
 3x  
 6020074  
  
 1x  
 6186542  
  
 3x  
 6097509  
  
 2x  
 6504997  
  
 1x  
 4216581  
  
 2x  
 6438899  
  
 2x  
 4211159  
  
 2x  
 4211166  
  
 1x  
 6078605  
  
 2x  
 4211149  
  
 1x  
 6468829  
  
 1x  
 6236915



2x  
6248918



1x  
4211186



1x  
4221775



2x  
6401957



1x  
6343322



1x  
6329581



1x  
4211483



1x  
6329584



2x  
4521921



1x  
4211535



2x  
4211414



1x  
4211398



1x  
4211469



2x  
4211388



1x  
6015344



1x  
4654046



2x  
6117967



2x  
6319336



2x  
4211397



1x  
6448319



2x  
4211445



1x  
4211395



2x  
6408542



1x  
4211452



1x  
4211425



1x  
6037399



1x  
4211406



1x  
4211010



1x  
6322821



1x  
6326495



2x  
6223767



1x  
6212501



2x  
6451205



2x  
6250598



1x  
6465604



4x  
6228969



2x  
6301835



2x  
6147726



1x  
6469559



2x  
6036232



6x  
4566607



6x  
6107200



16x  
6057386



4x  
6167464



2x  
4619657



1x  
6056774



2x  
6335111



1x  
6489716



8x  
6218360



2x  
6102998



1x  
6160320



4x  
6093494



1x  
6301636



4x  
6347603



4x  
6353587



3x  
6509766



1x  
6445924



4x  
6199893



2x  
6199900



1x  
6508744



4x  
6463129



1x  
6508759



1x  
6489715



1x  
6491152

 [LEGO.com/service](https://www.LEGO.com/service)

YOU COULD **WIN**



Scan this QR code or go to **LEGO.COM/PRODUCTFEEDBACK** and give us your short feedback about this LEGO® set for a chance to win a cool LEGO prize.

Terms and Conditions apply\*

**EN: YOU COULD WIN.** Terms and Conditions apply\* **DE: Du könntest GEWINNEN.** Es gelten die Teilnahmebedingungen\* **FR: Tu pourrais GAGNER.** Des conditions s'appliquent\* **IT: Potresti VINCERE tu.** Termini e condizioni sono applicabili\* **ES: Puedes GANAR.** Aplican términos y condiciones\* **PT: Poderá GANHAR.** Aplicam-se termos e condições\* **ZH: 轻松获奖. 条款和条件适用\*** **PL: Szansa na WYGRANĄ.** Obowiązują warunki korzystania\* **CS: Máte šanci VYHRÁT.** Platí všeobecné smluvní podmínky\* **SK: Máte šancu VYHRAŤ.** Platia všeobecné zmluvné podmienky\* **HU: TE IS NYERHETSZ.** Felhasználási feltételek érvényesek\* **RO: Ai putea CÂȘTIGA.** Se aplică termeni și condiții\* **BG: Можете да СПЕЧЕЛИТЕ.** Има определени правила и условия\* **LV: Tu vari LAIMĒT.** Ir spēkā noteikumi un nosacījumi.\* **ET: Sul on võimalus VÕITA.** Kehtivad tingimused\* **LT: Jūs galite LAIMĖTI.** Taikomos sąlygos\*

\*[LEGO.com/productfeedback-terms](https://www.lego.com/productfeedback-terms)