

HISTORICAL COLLECTION

WORLD WAR II



M4A3E8 SHERMAN "EASY EIGHT"
IN SERVICE - 1944-1980's
PLACE OF ORIGIN - UNITED STATES
TYPE - MEDIUM TANK
WEIGHT - 30,3t (66,800Lb)
ARMOUR - 76MM (3") MAXIMUM
ARMAMENT - 1x GUN 76MM L/55 M1A12,
1x MG 12,7MM (.5") BROWNING M2HB
ENGINE - 1x DOHC FORD GAA V8, 518HP
SPEED - 48KM/H (30MPH) 
CREW - 5

2711

PAD PRINTED
NO STICKERS

Printed in EU



320 

M4A3E8 SHERMAN

SCALE 1:48

1

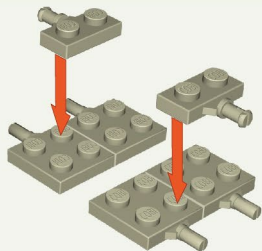

x4



x2

2

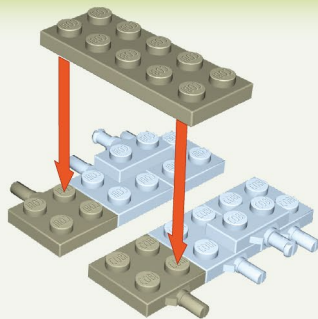

x2



x1

3

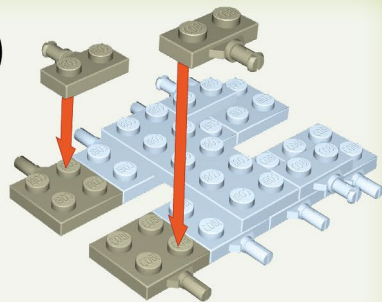

x2



x2

4

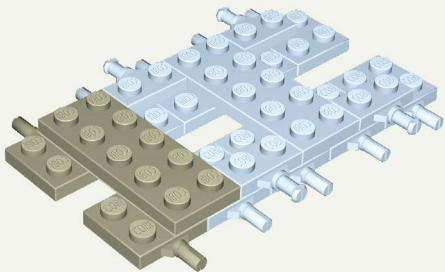

x2



x1

5

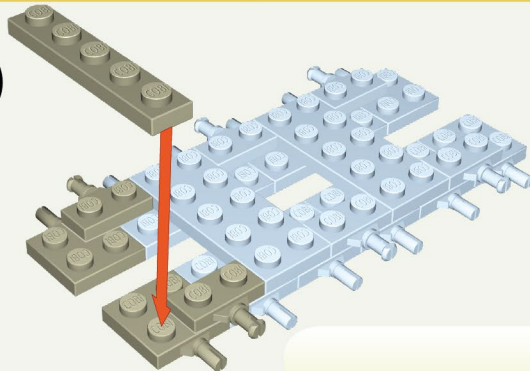

x2



x2

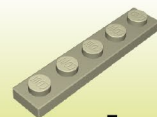

x1

6

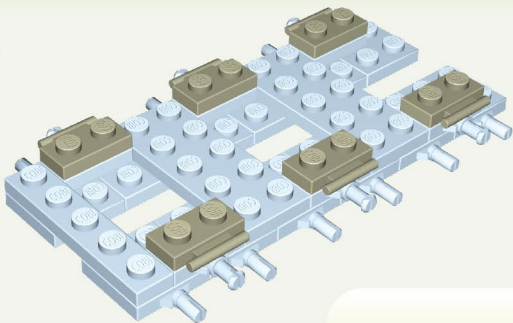

x6

7

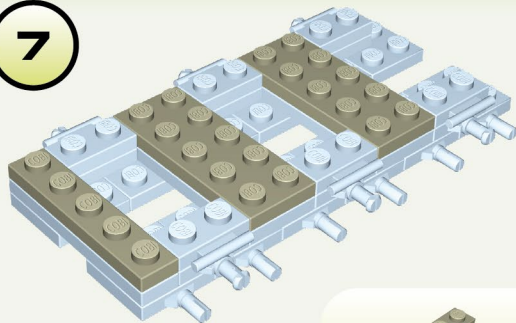

x1



x2

8

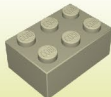
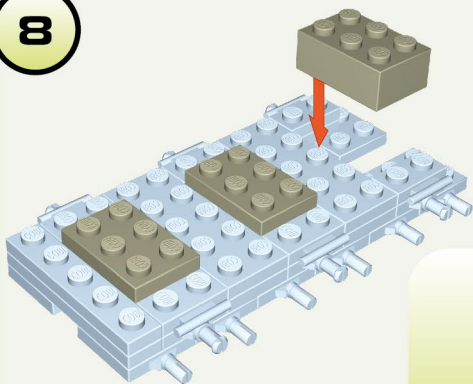

x3

9

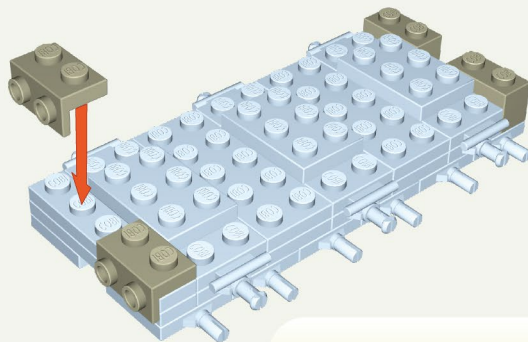

x2



x2

10

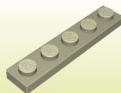
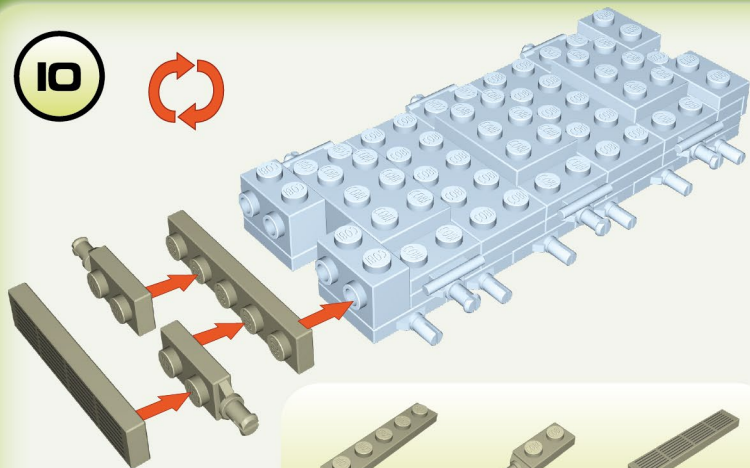

x1



x2

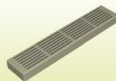

x1

11

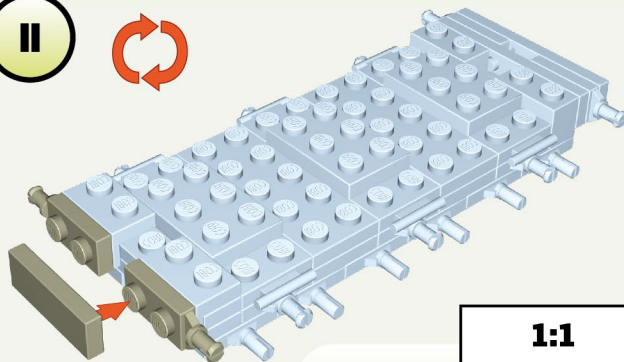

1:1



x2



x1

12

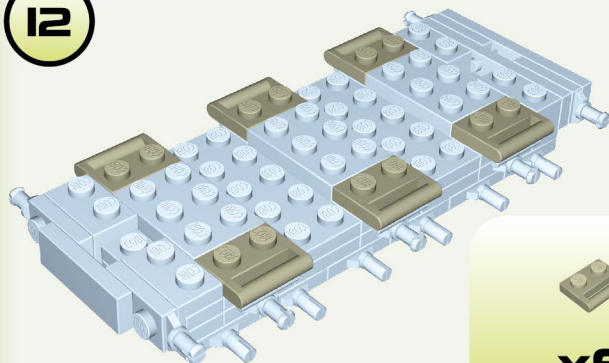

x6

13

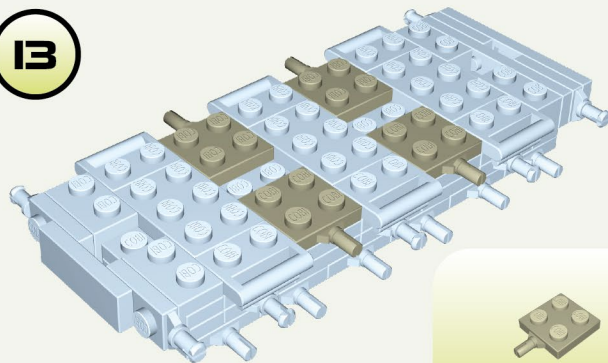

x4

14

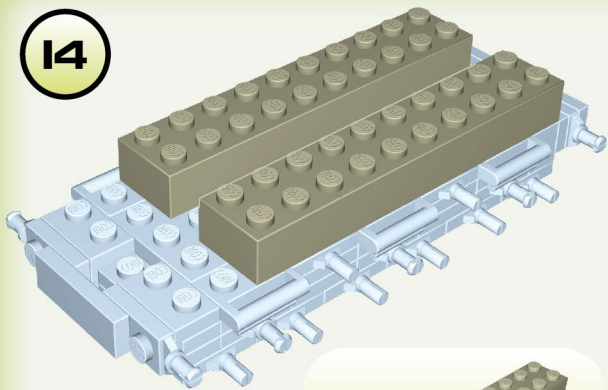

x2

15

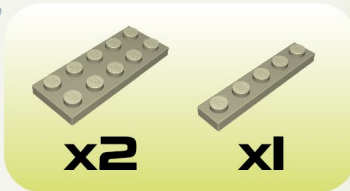
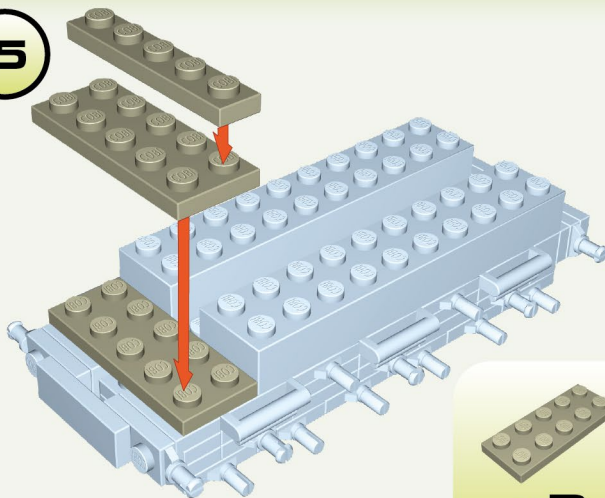

x2

x1

16

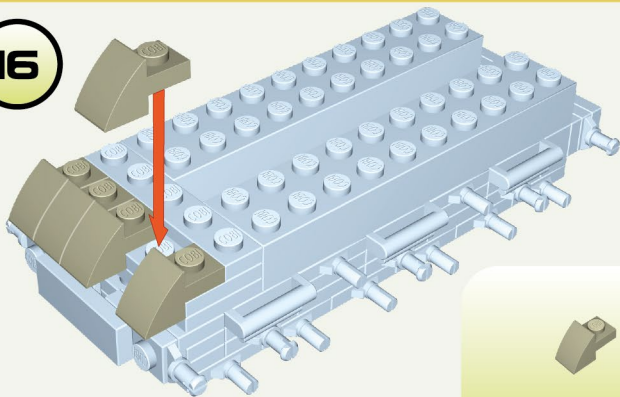

x5

17

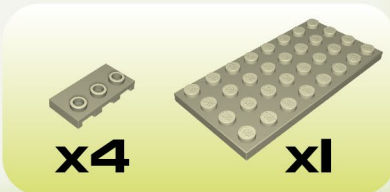
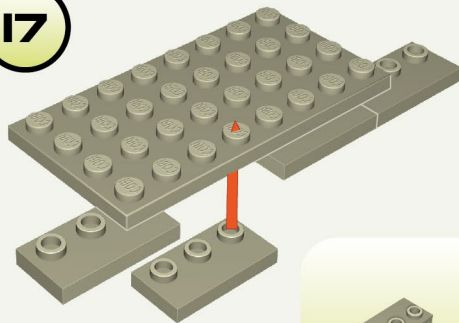

x4

x1

18

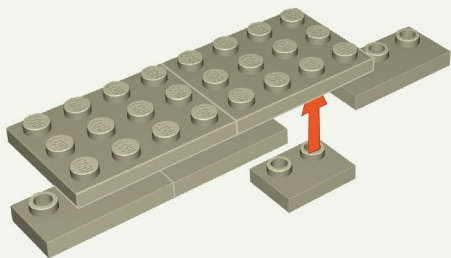

x2



x3



x1

19

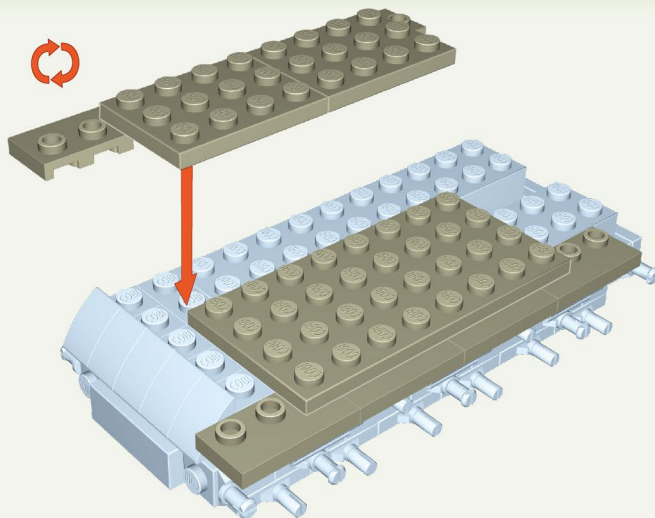

20

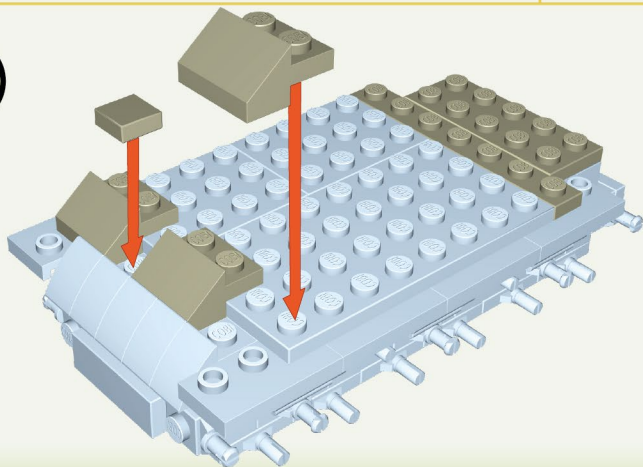

x1

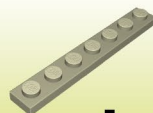

x1



x3



x1

21

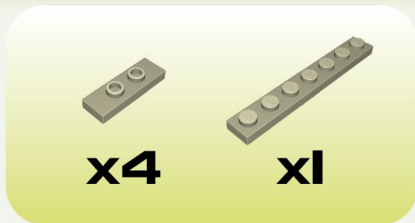
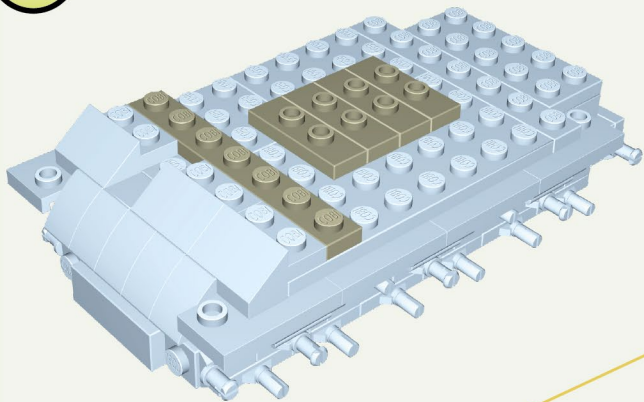

22

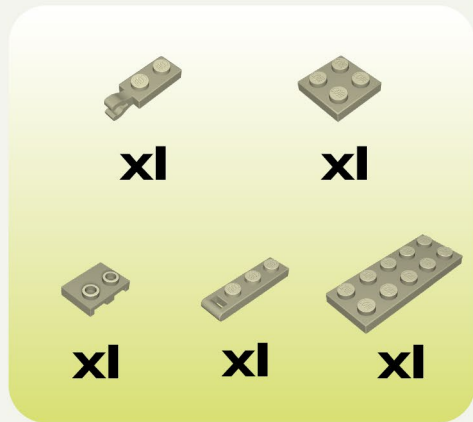
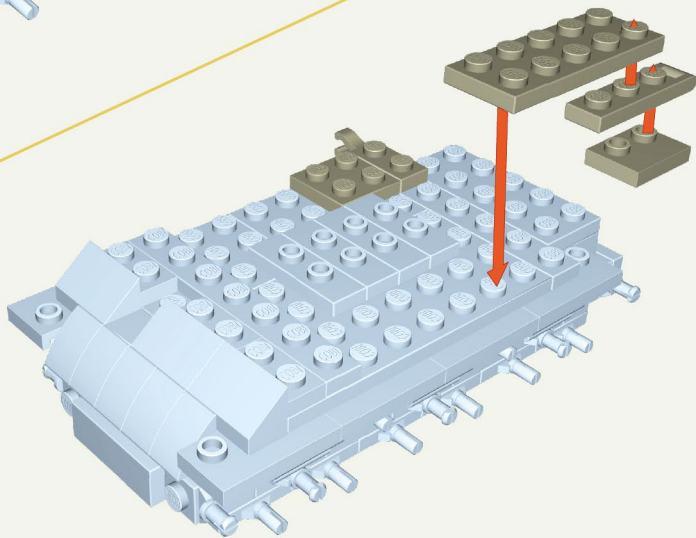

23

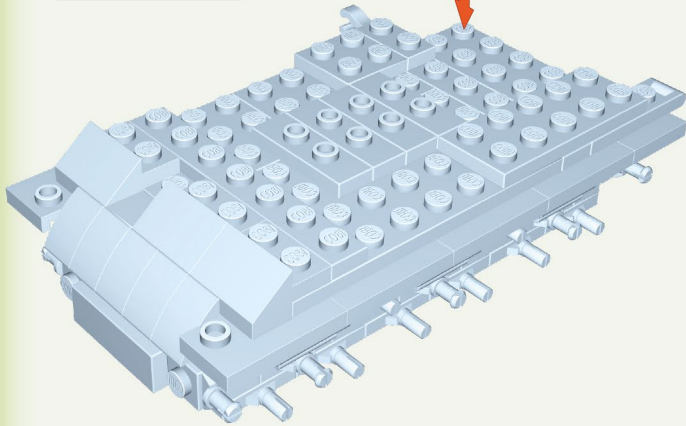
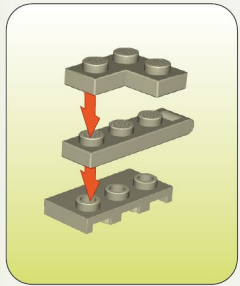

24

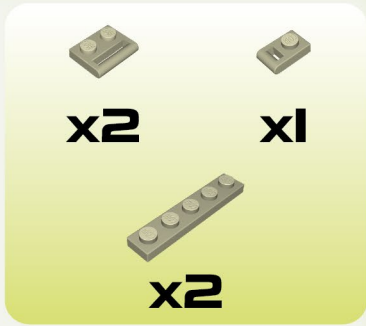
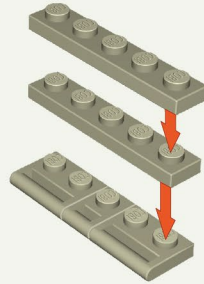

25

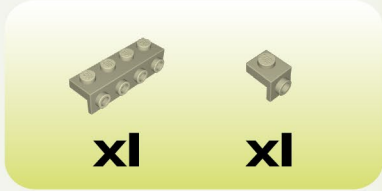
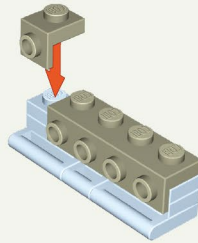

26

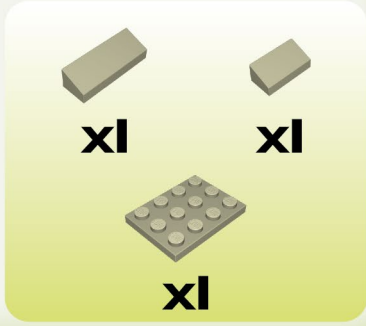
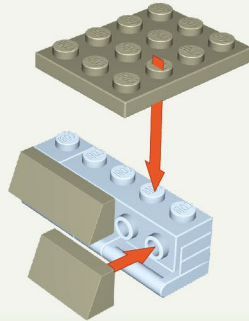

27

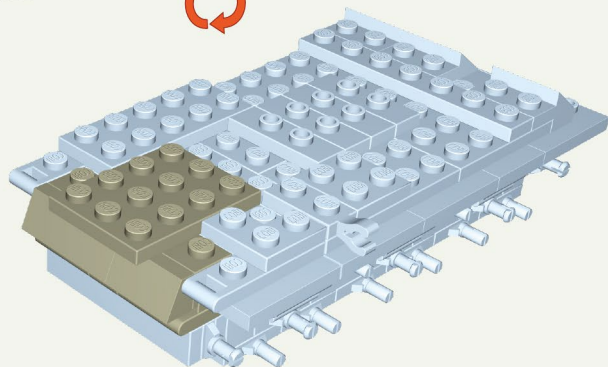

28

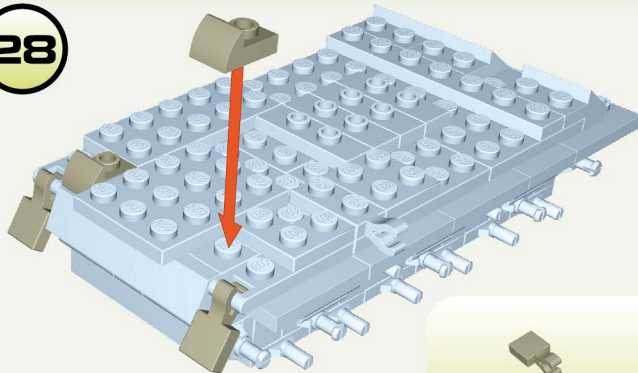

x2



x2

29

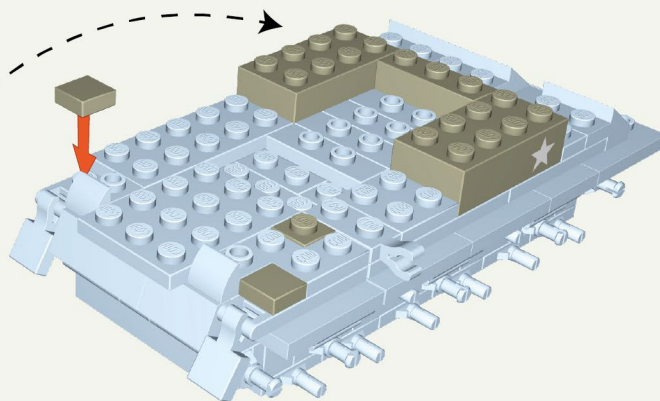
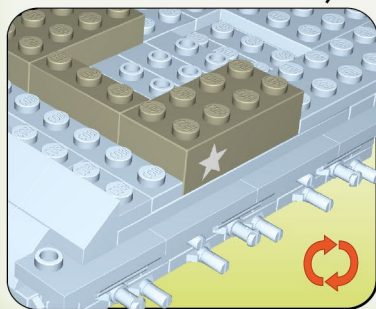

x1



x1



x1



x1



x2

30



x2



x2



x1

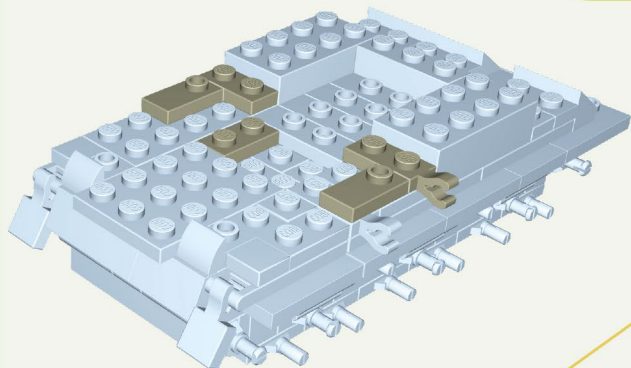

31

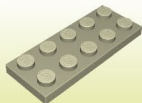
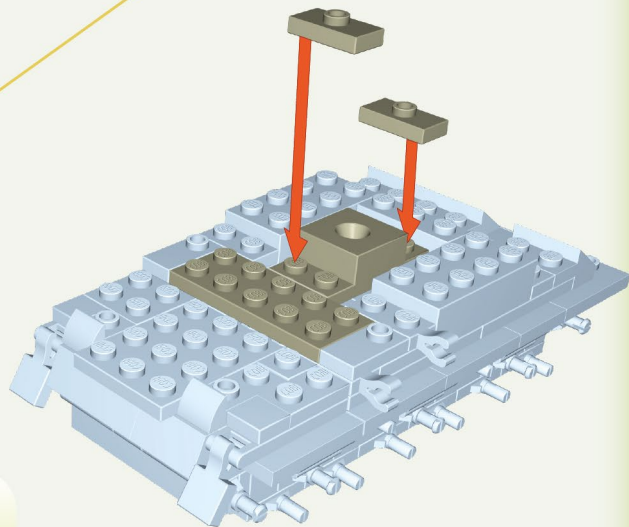

x1

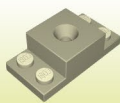

x1



x2

32

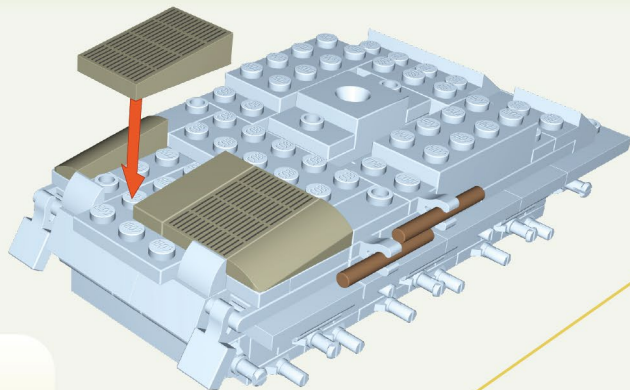

33

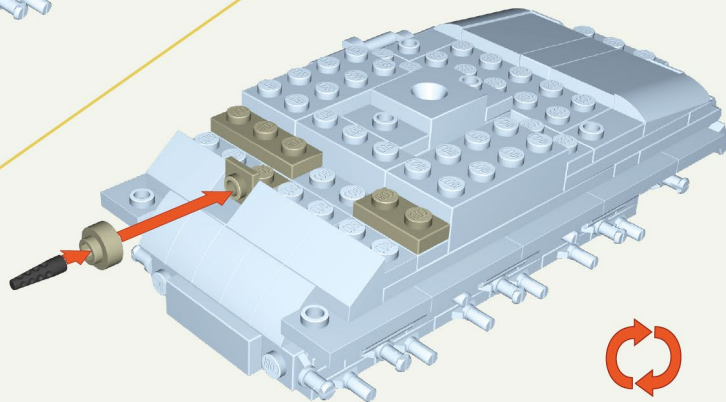

x1	x1
x1	x2
	x2

x1	x1	x1	x1	x1

34

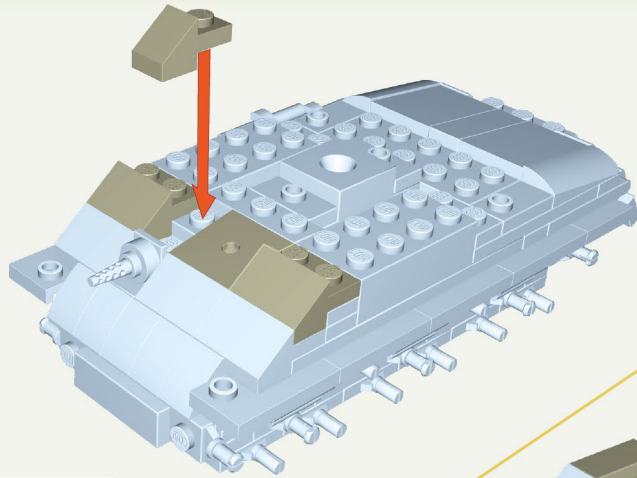

x1 x2 x1

35

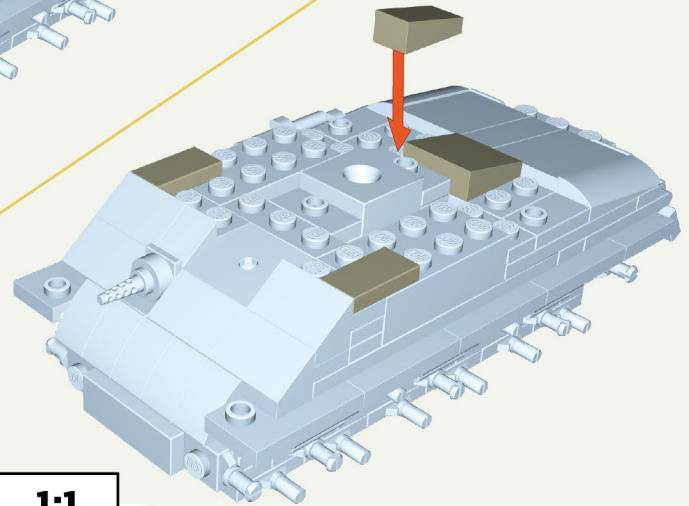



1:1

x1 x1 x2

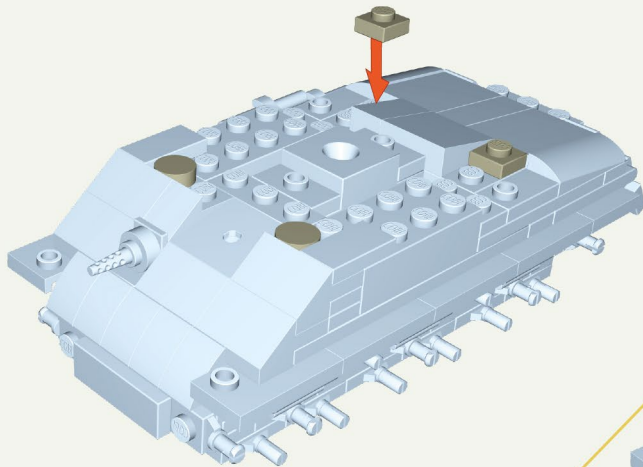
36





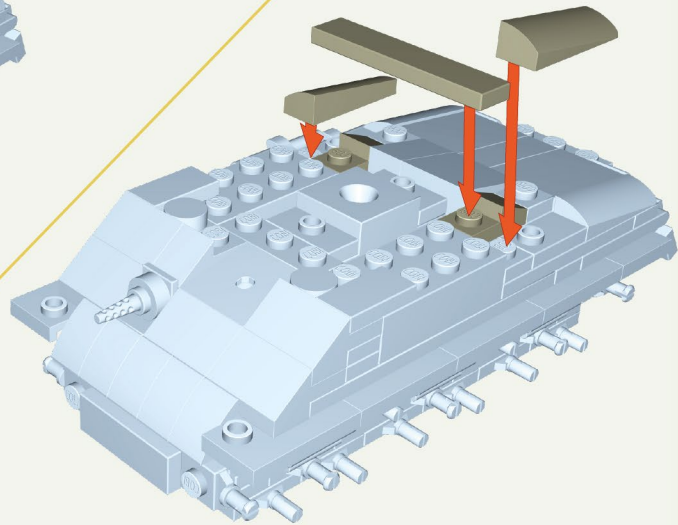

x2 **x2**

37

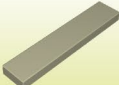

1:1



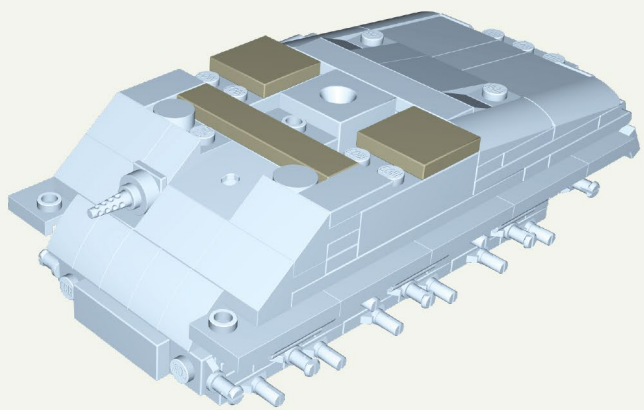

x2 **x1** **x1** **x1**

38

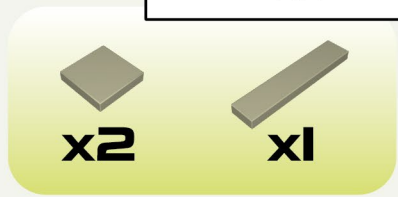

1:1



39

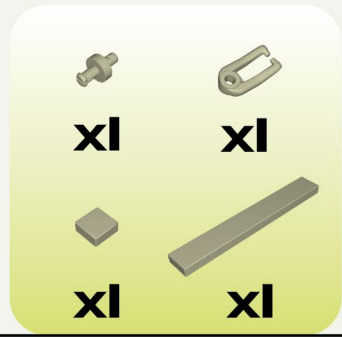
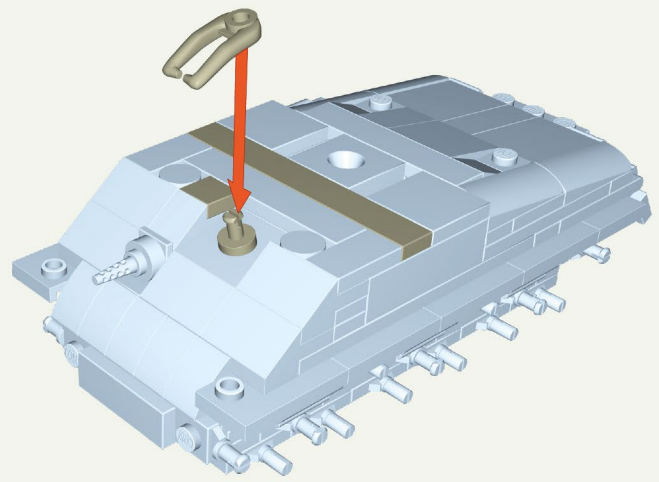

1:1

40

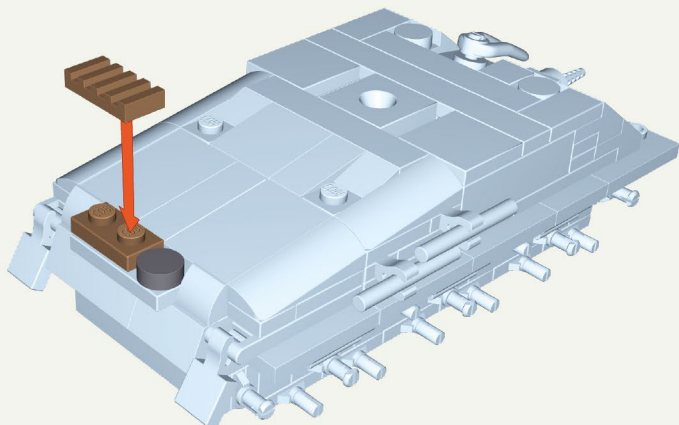

x1



x1



x1

41



x12

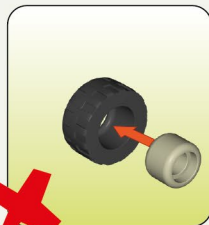

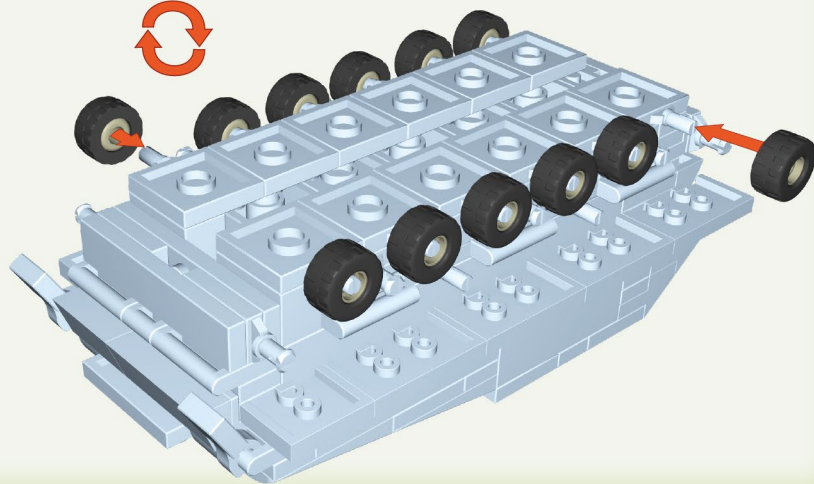

x12

x12

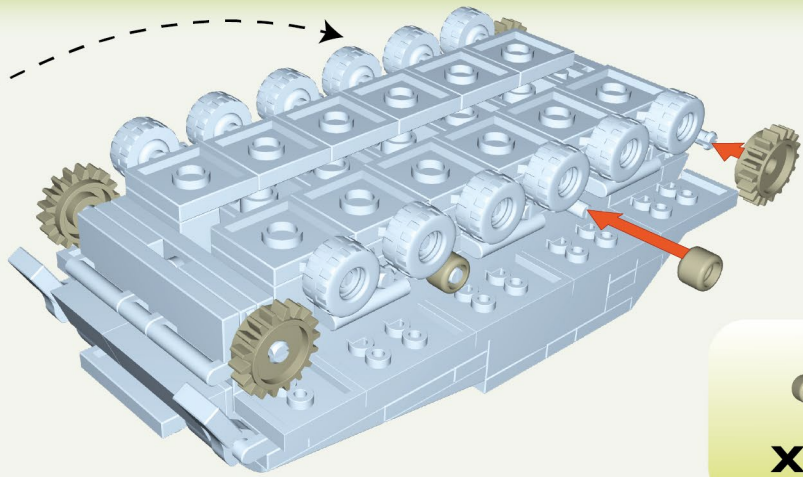
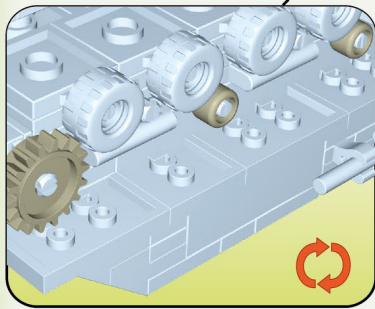

42



 
x4 **x4**

43

x64

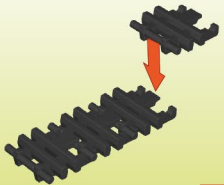
x32

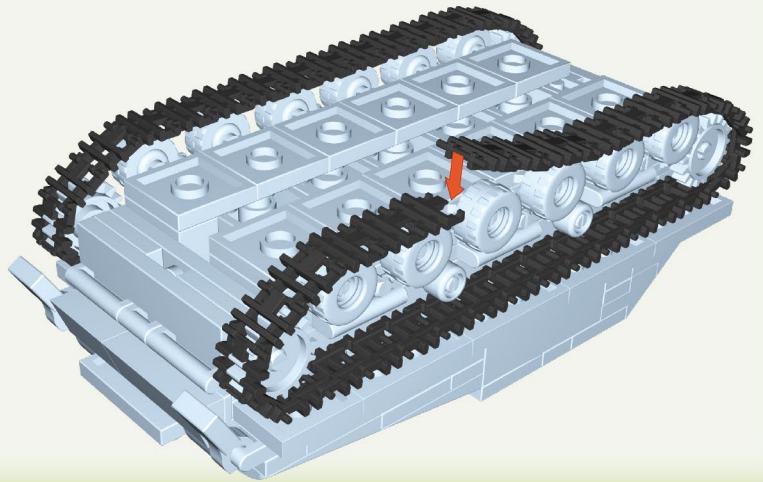
x2

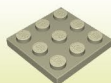
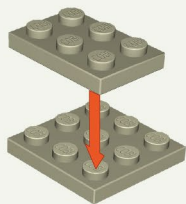

44



x1



x1

45

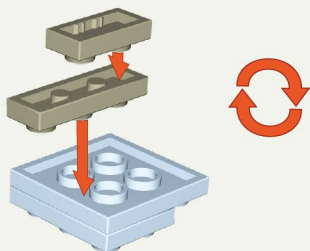

x1



x1

46

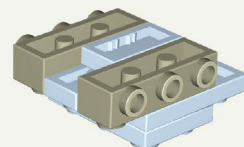

x2

47

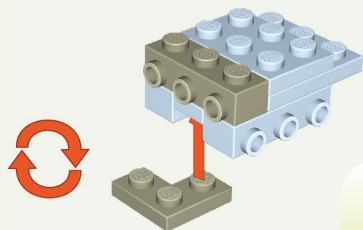

x1



x1

48

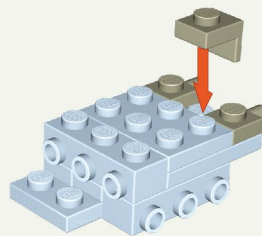

x2



x1

49

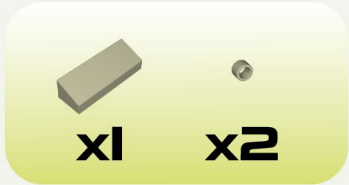
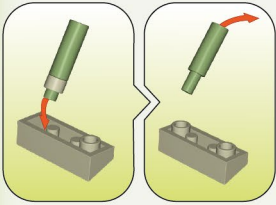
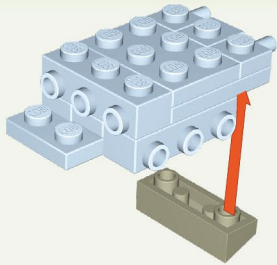

50

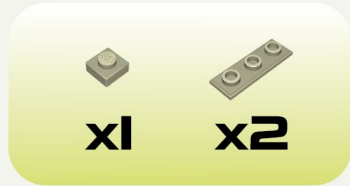
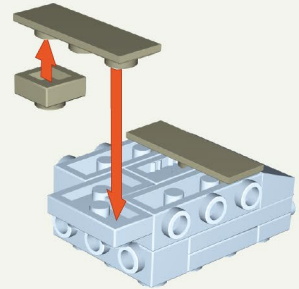

51

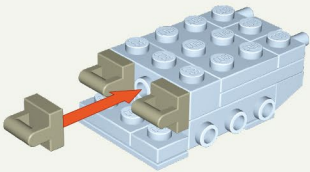

52

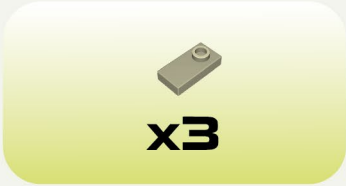
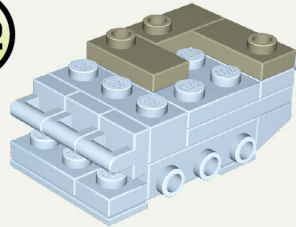

53

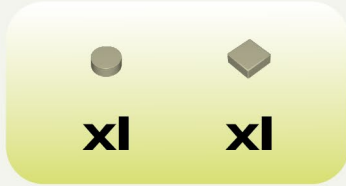
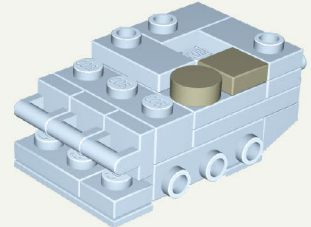

54

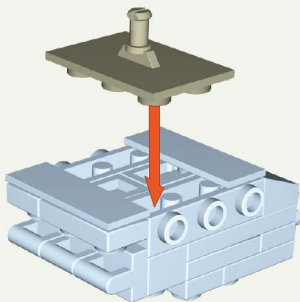

x1

55

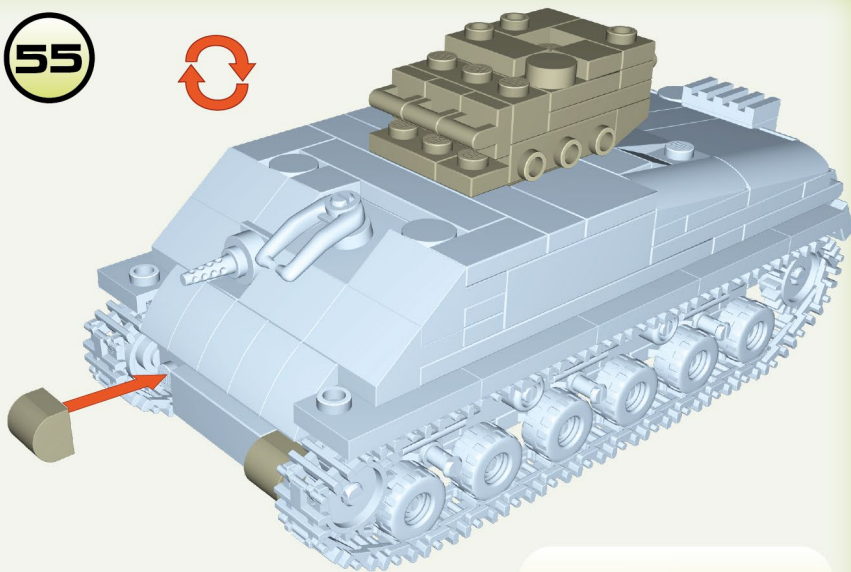

56

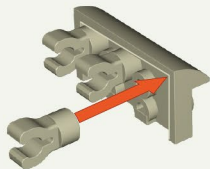

x1



x3

57

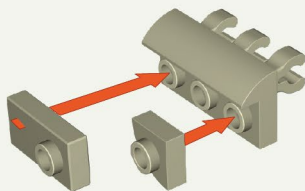

x2



x1



x1

58

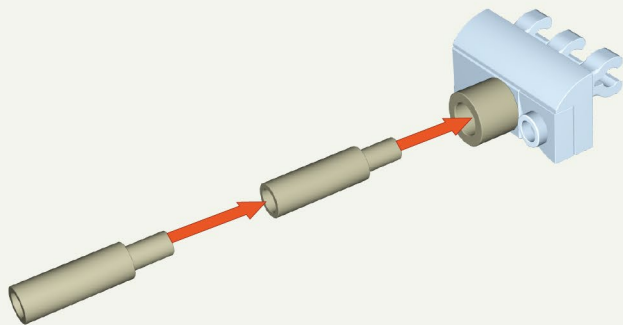

x1



x2

59

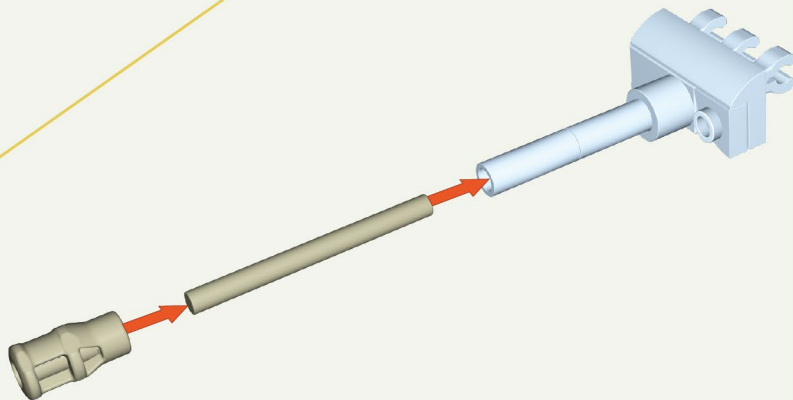

x1



x1

60

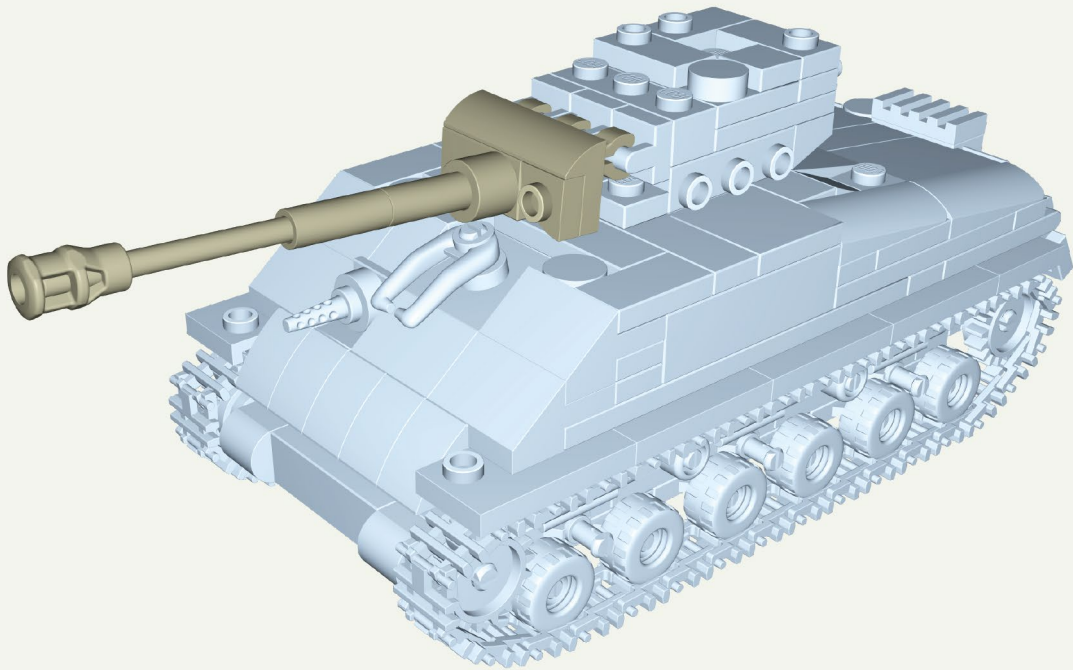

61

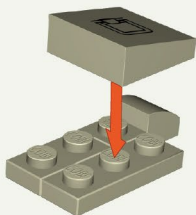
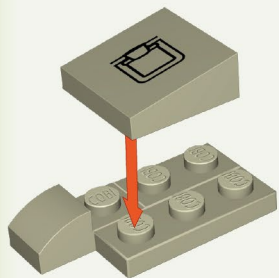

x2



x2



x2



x1



x1

62

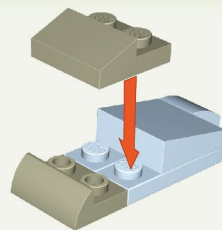
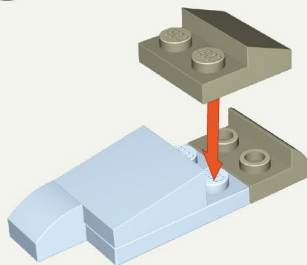

x2



x2

63

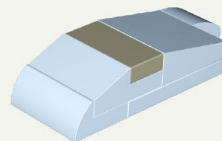
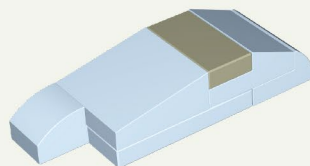

1:1



x2

64

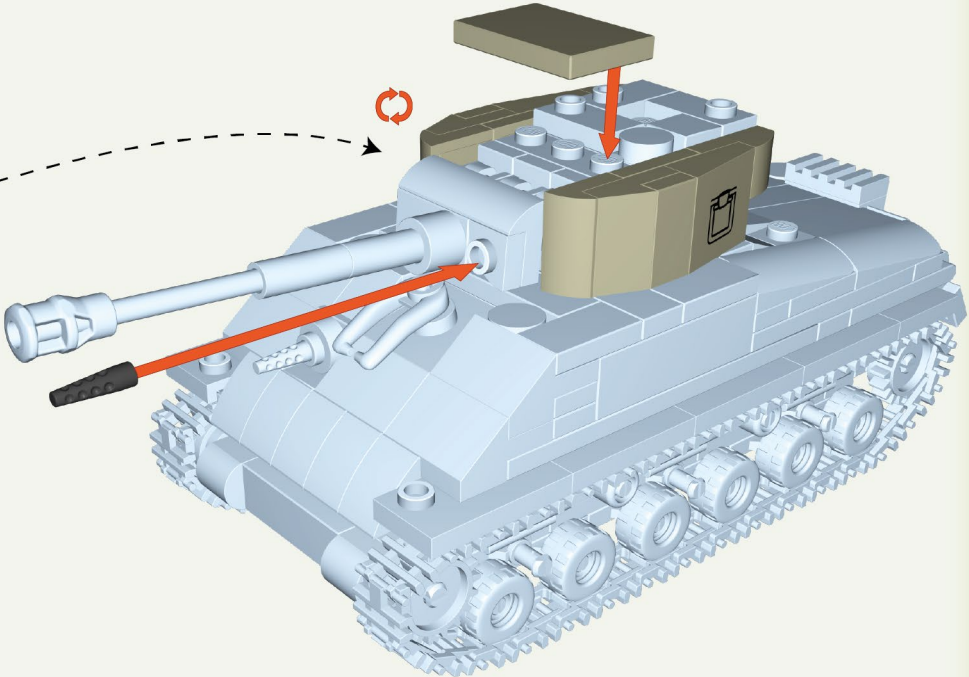
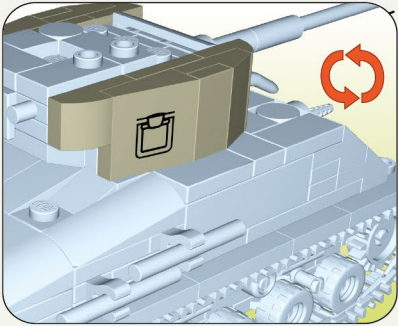
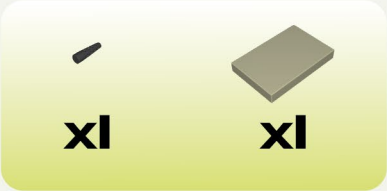

65

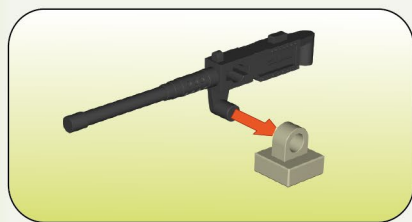
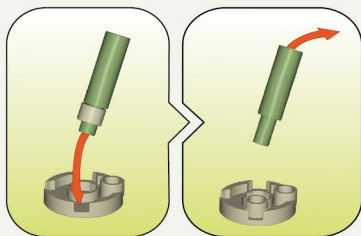

x1



x2



x1



x1

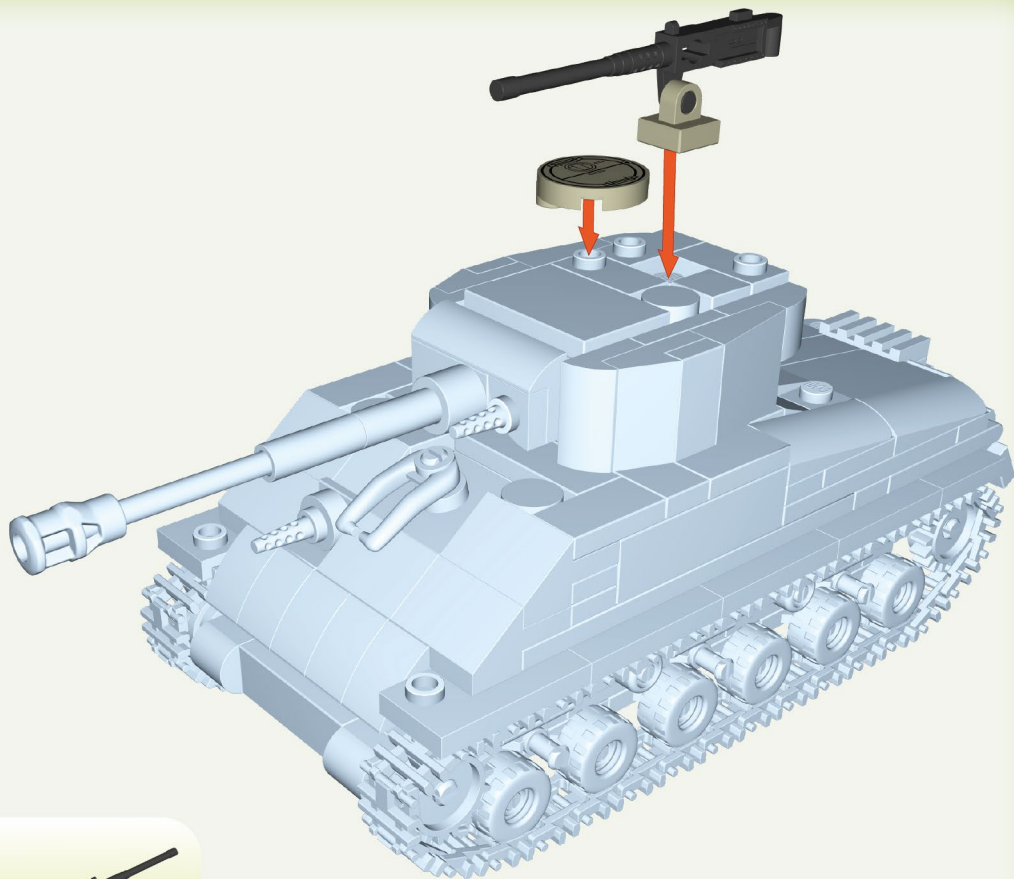



x2
134434



x2
141251



x2
129720



x8
142702



x1
129721



x4
129722



x1
142673



x2
141239



x2
141115



x2
129755



x1
129727



x1
129701



x5
129728



x1
100990



x3
129729



x3
129732



x1
129734



x5
130630



x1
129741



x1
42928



x6
129744



x2
141249



x2
129746



x4
129749



x6
142703



x1
100921



x2
129750



x2
129751



x5
130704



x2
129753



x6
129703



x6
141247



x2
142698



x1
130629



x5
130632



x1
129872



x4
129763



x1
129765



x4
129766

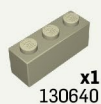

x1
130640



x3
129873



x2
132328



x2
132366



x2
129768



x2
129769



x1
142696



x6
129777

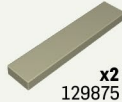

x2
129875



x1
142642



x2
129781

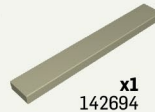

x1
142694



x1
129785



x2
129786



x1
142643

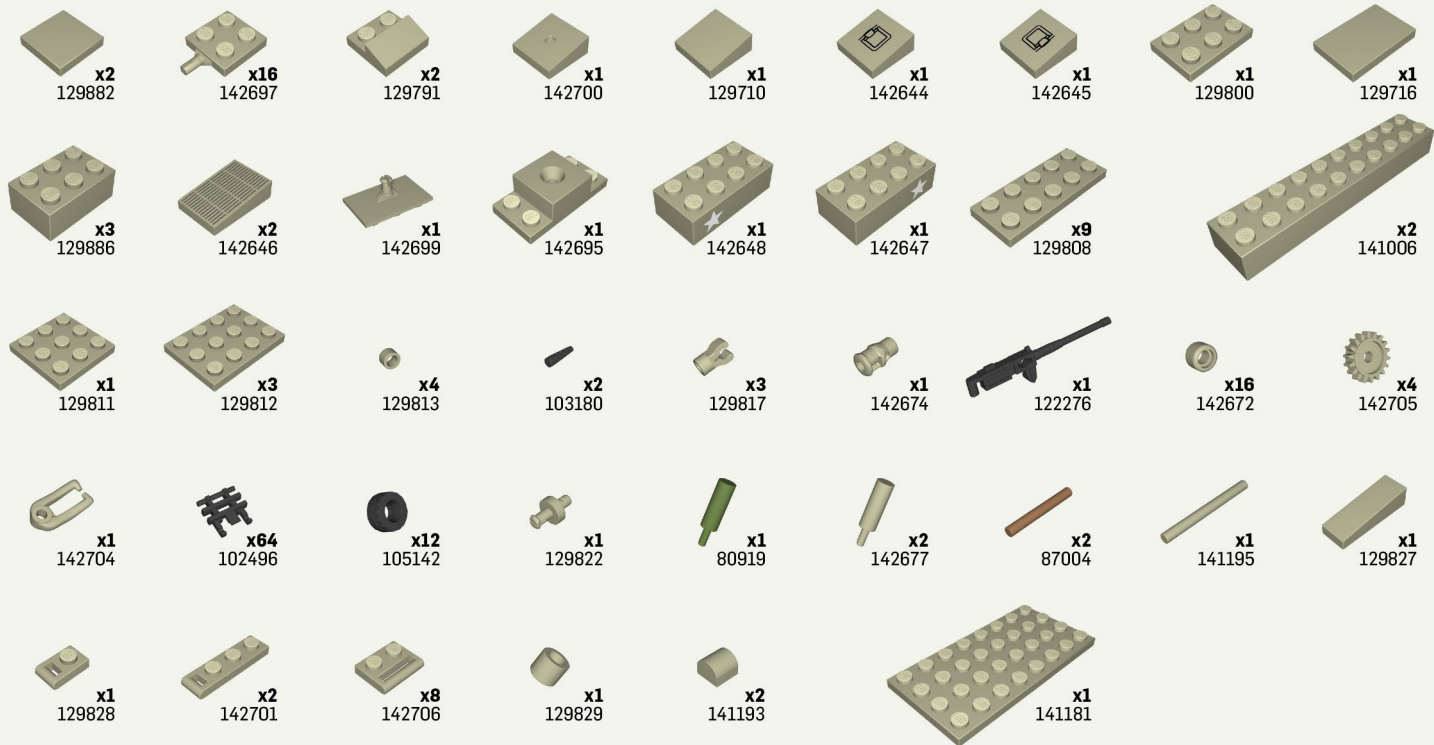



HISTORICAL COLLECTION



RENAULT R35
+ 2553



PANZER VIII „MAUS”
+ 2559



FLAKPANZER IV WIRBELWIND
+ 2548



CITROËN 15CV SIX D
+ 2267



HISTORICAL COLLECTION



SHERMAN M4A1
scale 1:48
★ 2715



PzKpfw VI TIGER "131"
scale 1:48
+ 2710



PzKpfw VI TIGER "131"
+ 2556



WARNING: CHOKING HAZARD-
Toy contains small parts.
Not for children under 3 years.

For
news and
special deals

Find us on:
  [cobi.bricks](https://www.facebook.com/cobi.bricks)
[cobi.bricks](https://www.instagram.com/cobi.bricks)
 [cobi.bricks](https://www.youtube.com/cobi.bricks)
COBI SA

WWW.COBI.EU

19-02711-316