

# HISTORICAL COLLECTION

## WORLD WAR II

### VICKERS WELLINGTON MK II

PLACE OF ORIGIN - UNITED KINGDOM  
 IN RAF SERVICE - 1939 - 1945  
 ROLE - MEDIUM BOMBER  
 CREW - 6  
 WINGSPAN - 26,27M (86' 2")  
 LENGTH - 19,69M (64' 7")  
 HEIGHT - 5,31M (17' 5")  
 WEIGHT - 8435KG (18,556LB)  
 ENGINE - 2x BRISTOL PEGASUS XVIII, 2x 1050HP (780KW)  
 RANGE - 4106KM (2,558MI)  
 RATE OF CLIMB - 5,7M/S (1,120FT/MIN)  
 MAXIMUM FLIGHT LEVEL - 5490M (18,000FT)  
 SPEED - 378KM/H (235MPH)  
 ARMAMENT - 8x 7,7MM (.303") BROWNING GUNS,  
 2040KG (4,500LB) BOMBS



**PAD PRINTED**  
**NO STICKERS**

Printed in EU 5723

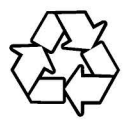

**WARNING: CHOKING HAZARD-**  
 Toy contains small parts.  
 Not for children under 3 years.

1162 2

**VICKERS WELLINGTON MKII**

SCALE **1:37**



BE CAREFUL: NOTICE THE DIFFERENCE

A



B



UWAGA: RÓŻNE KLOCKI

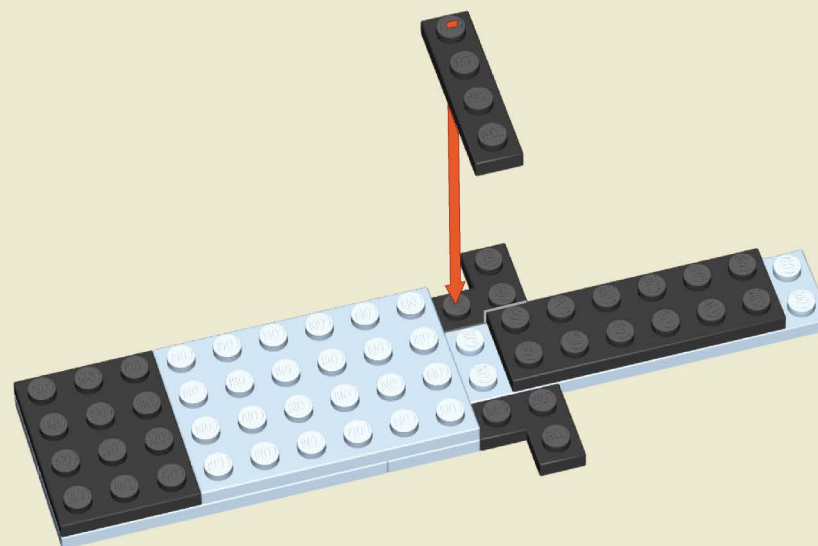
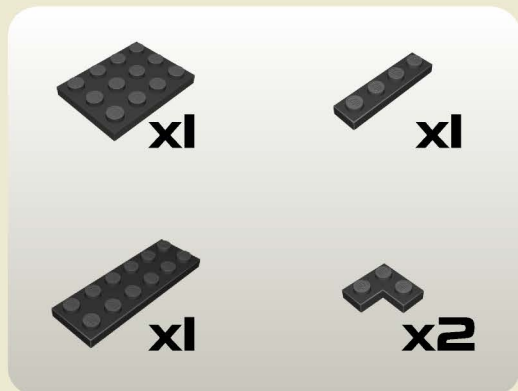
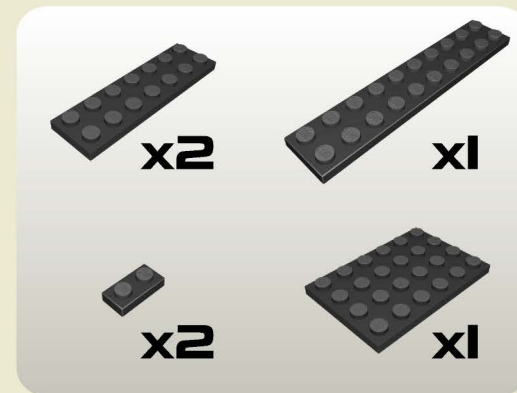
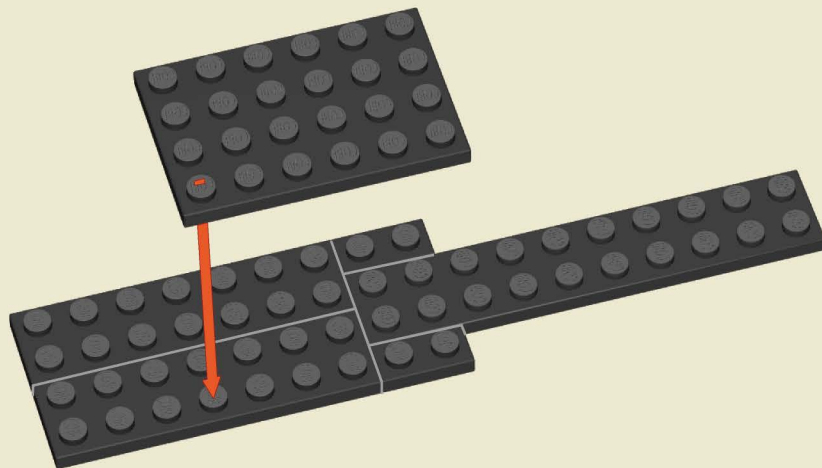

3

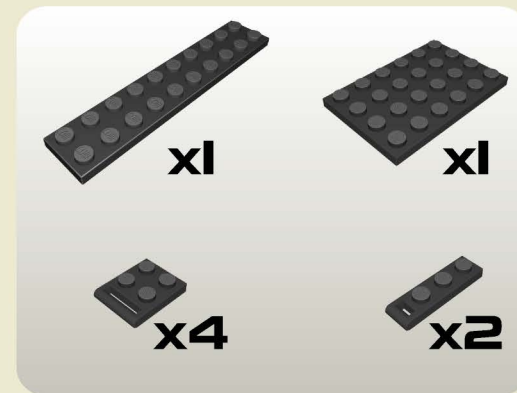
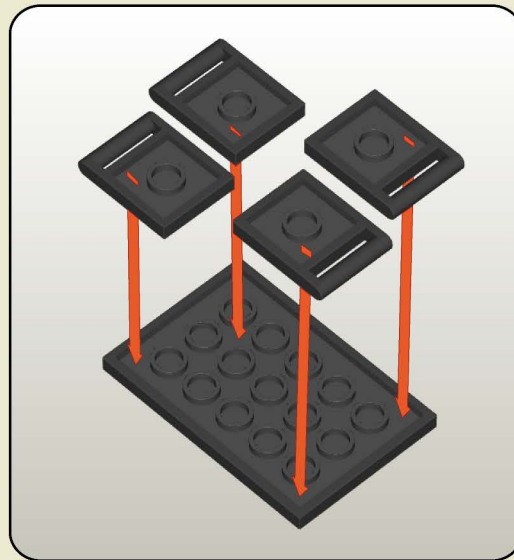
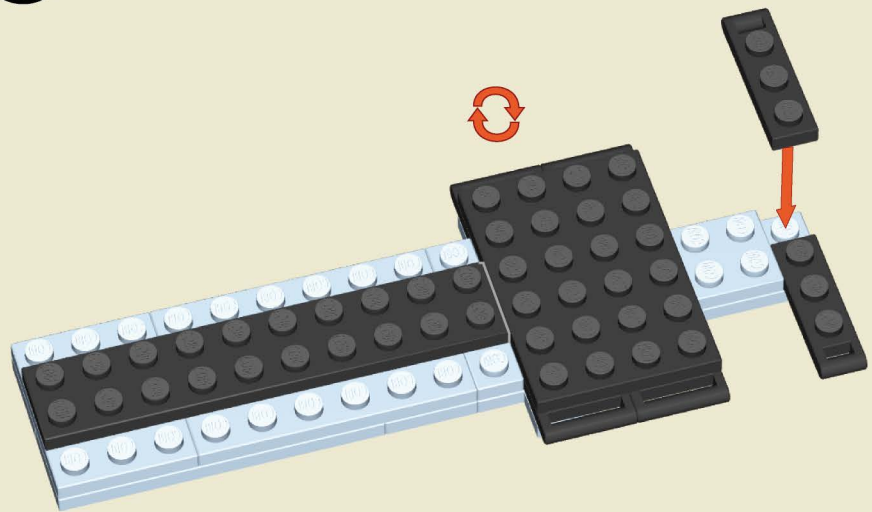

4

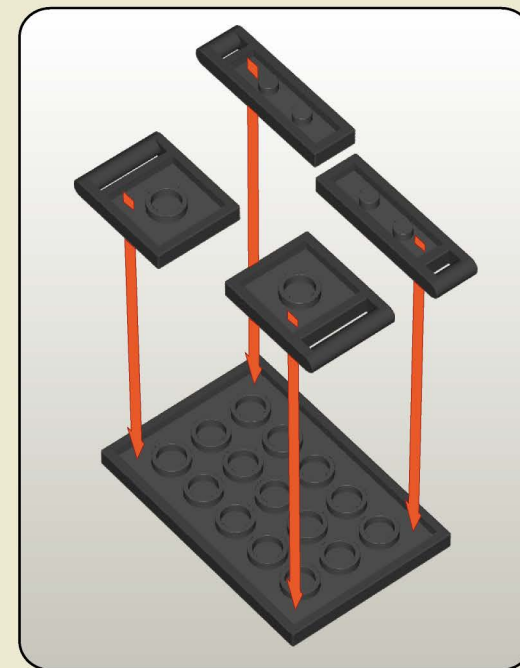
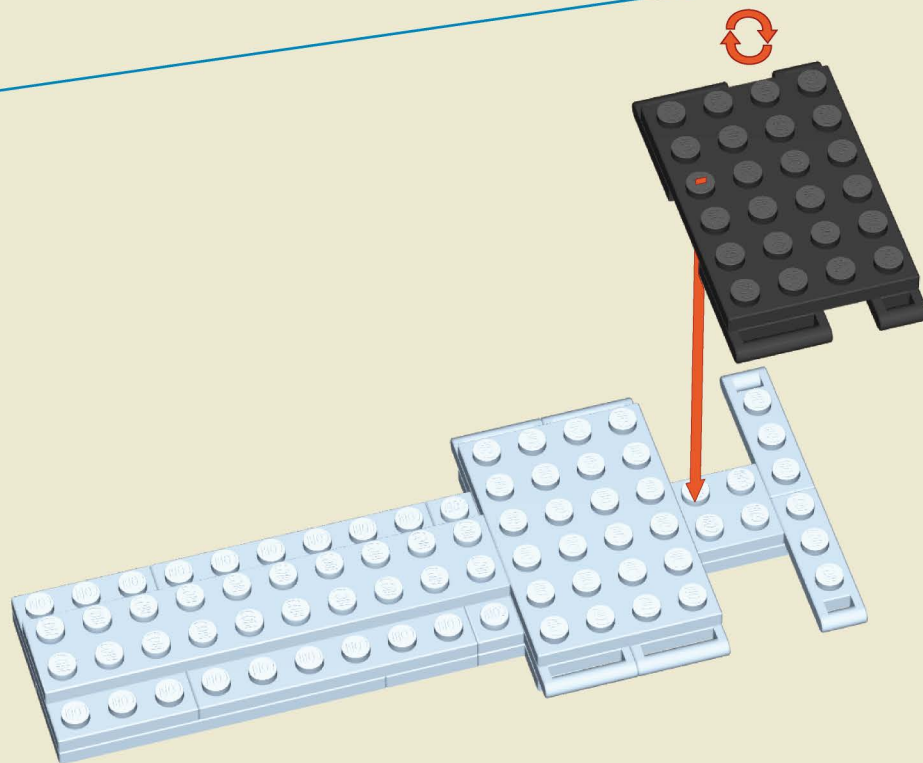
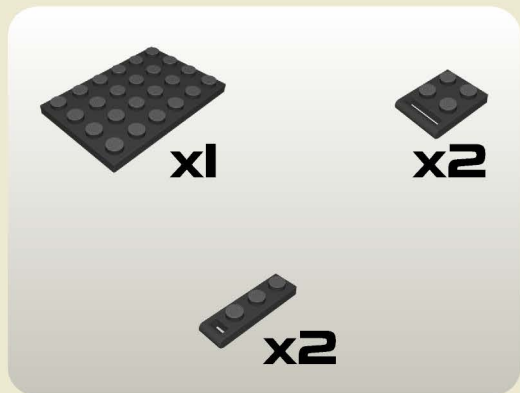



5

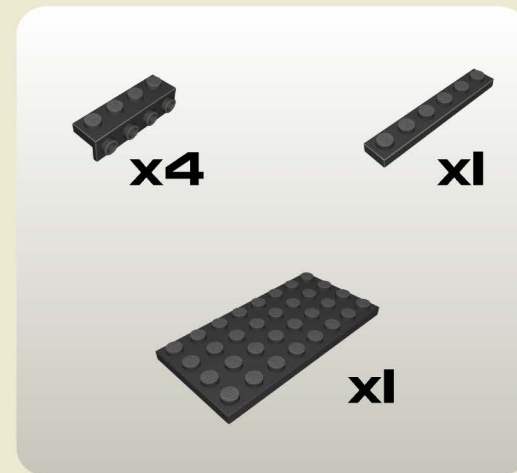
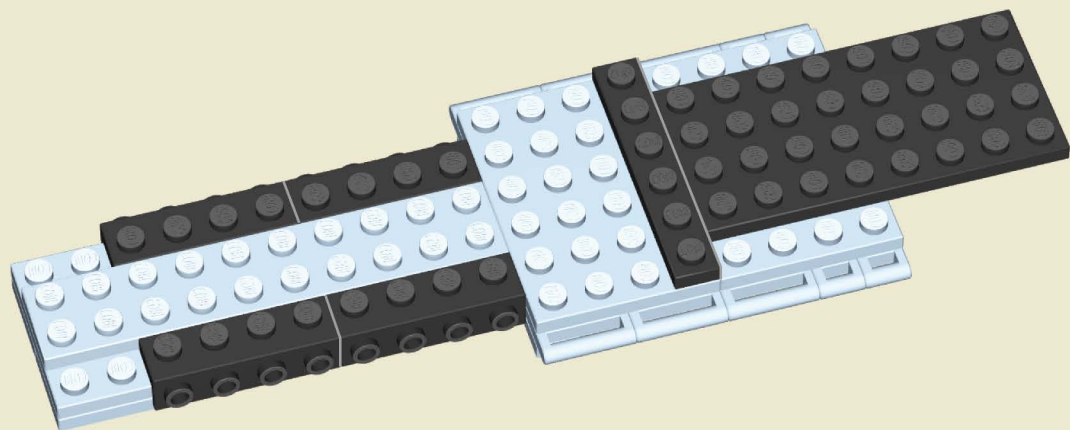

6

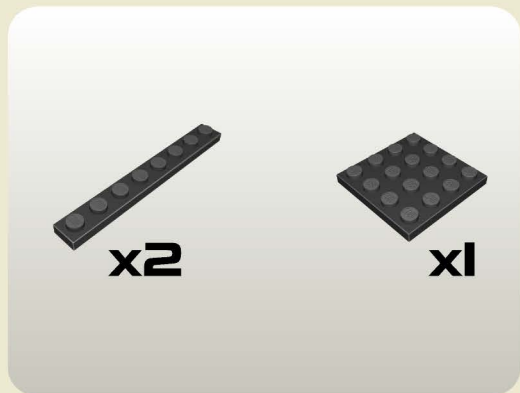
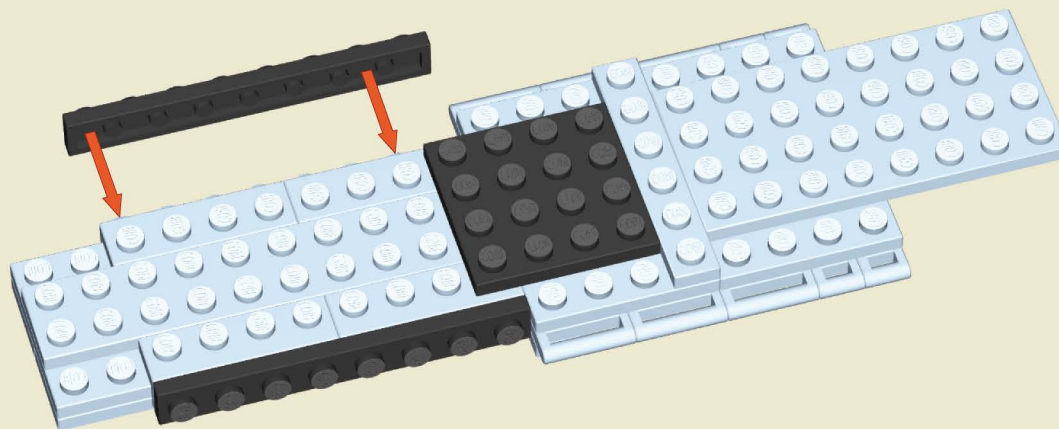



7

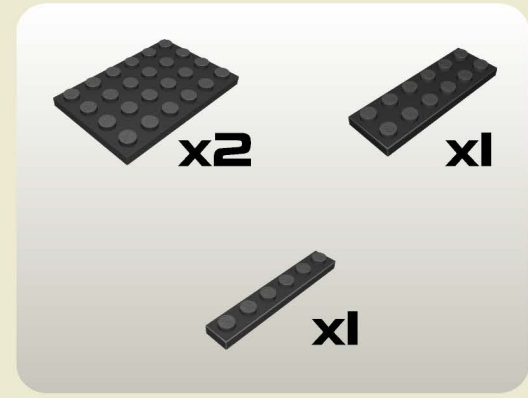
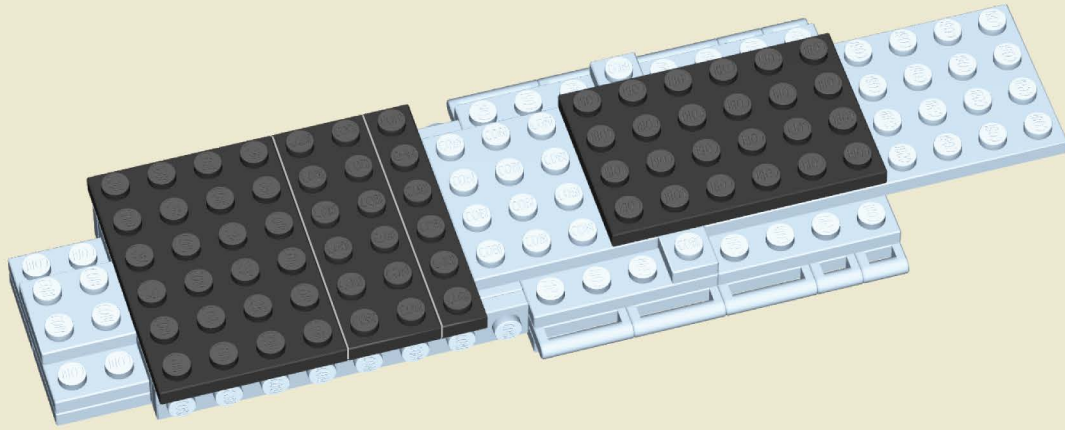

8

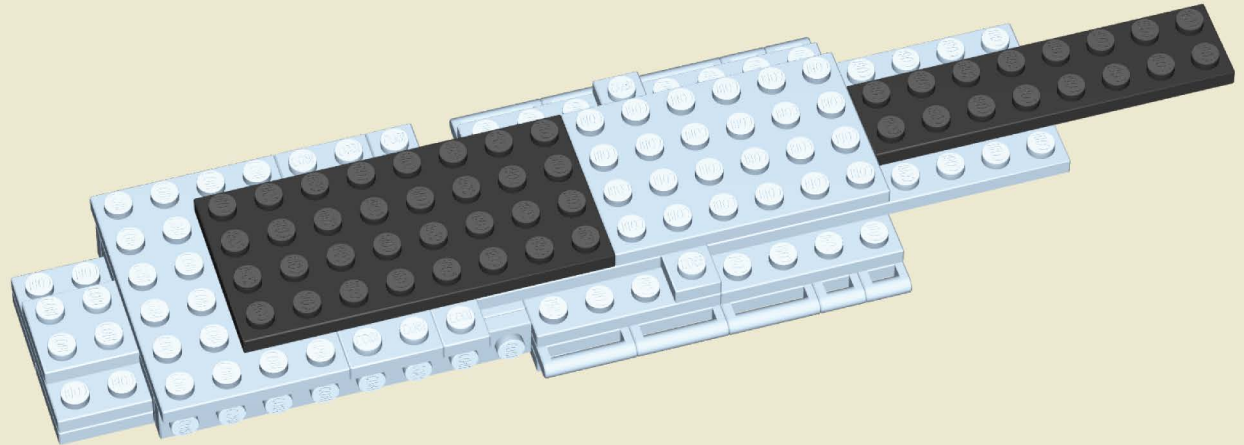
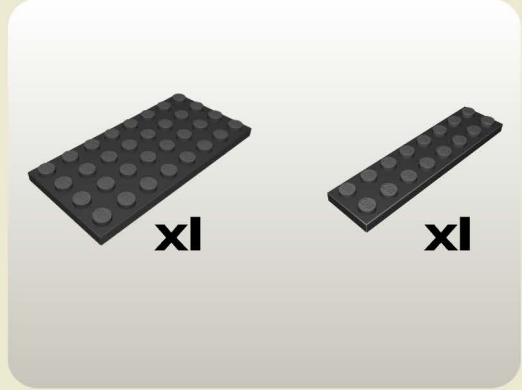

9

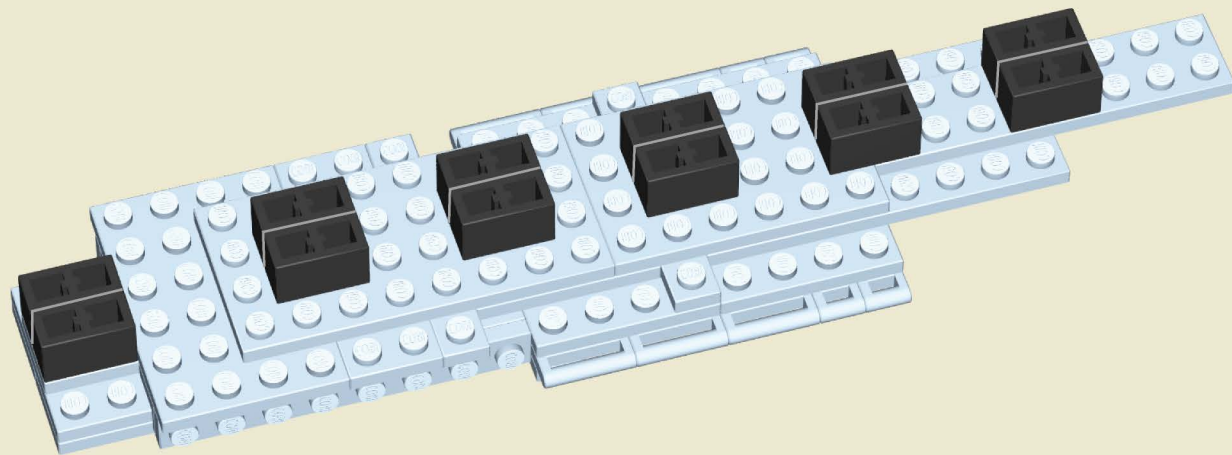

10

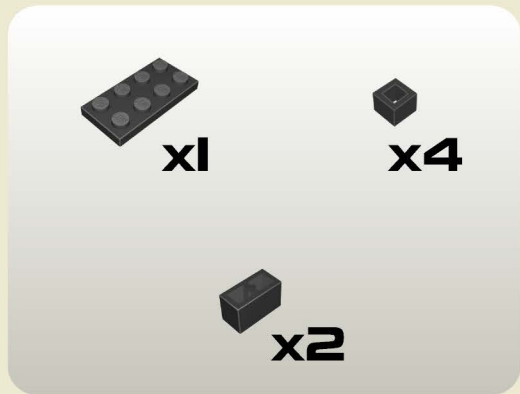
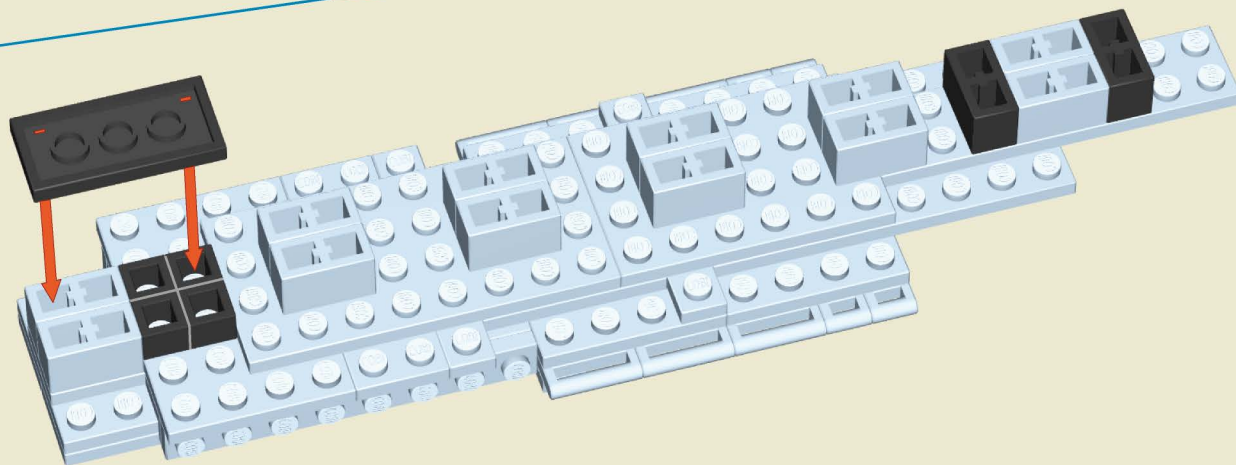

11

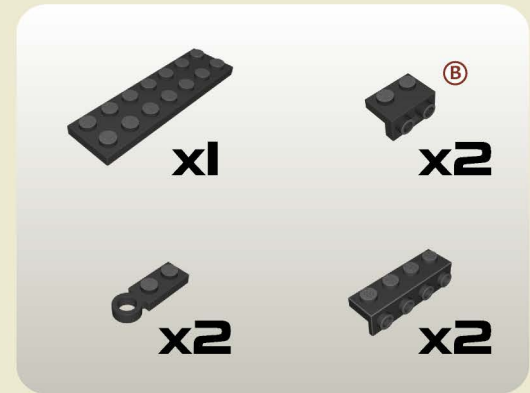
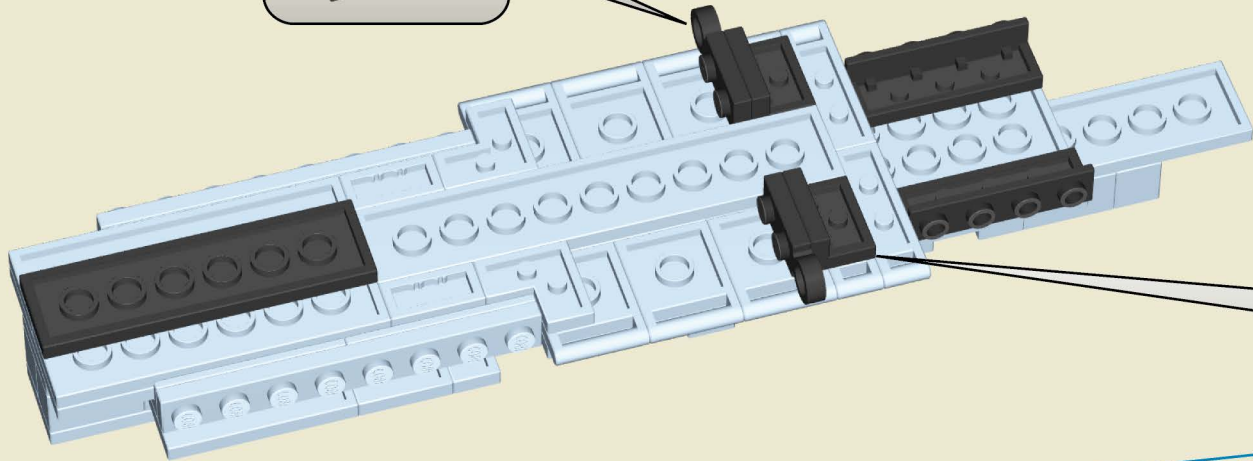
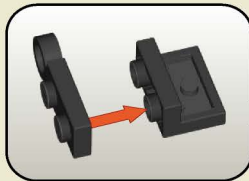

12

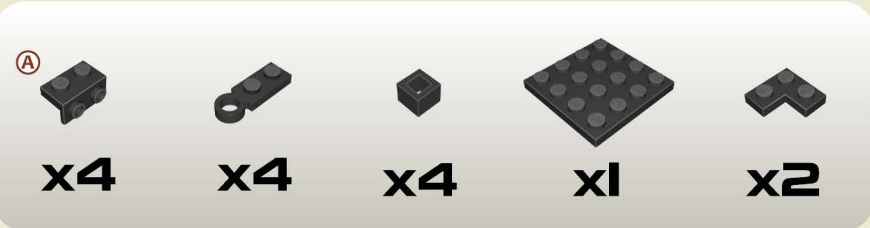
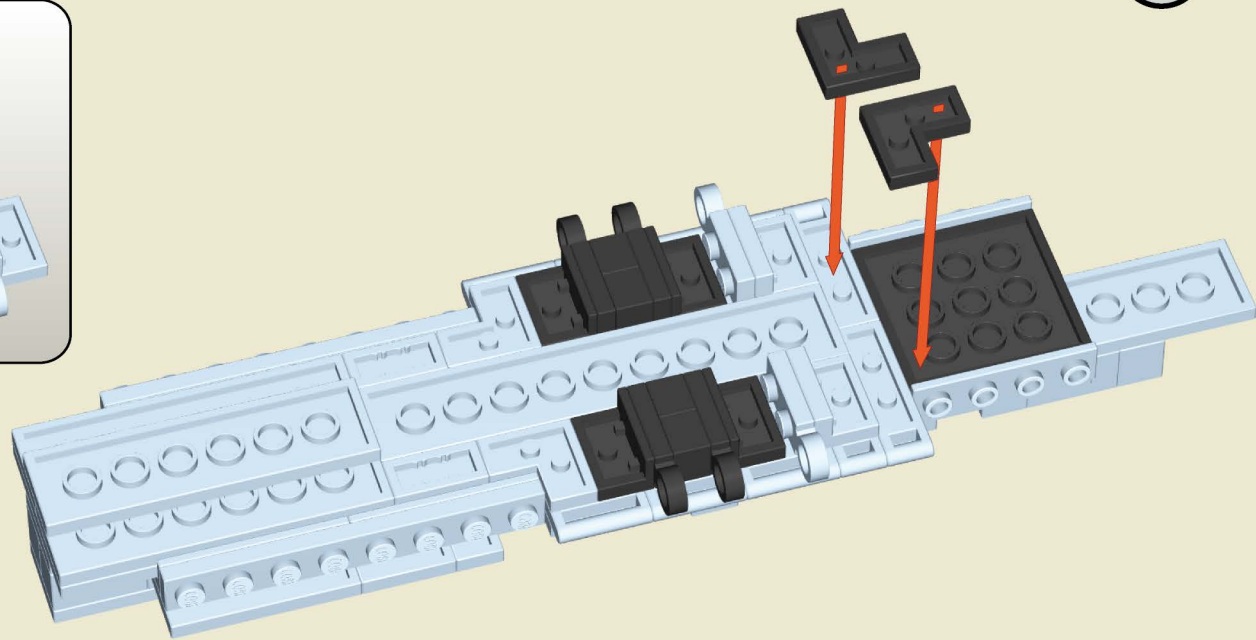
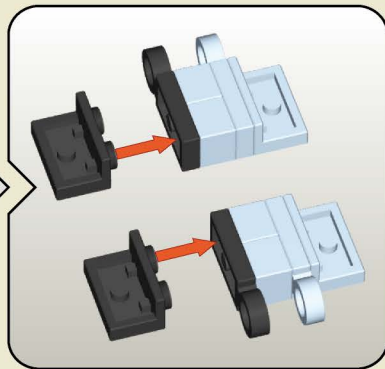
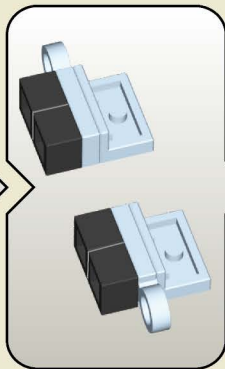
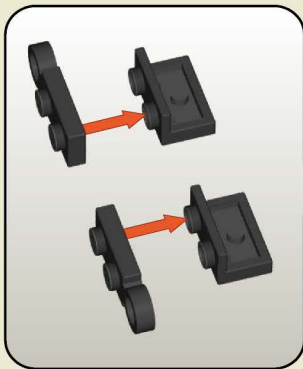



13

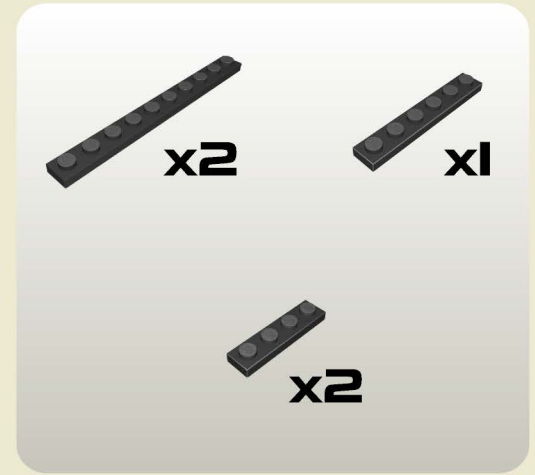
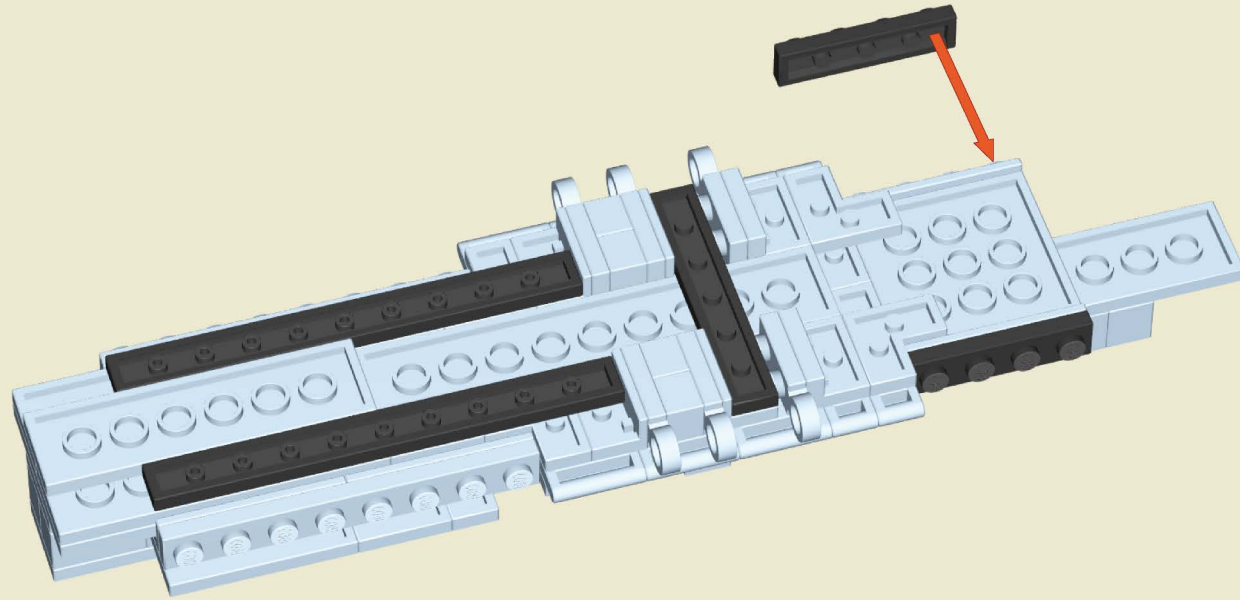

14

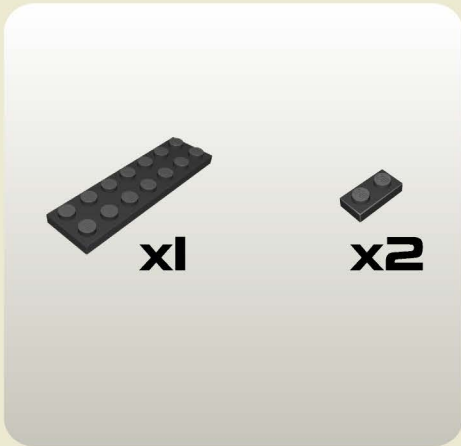
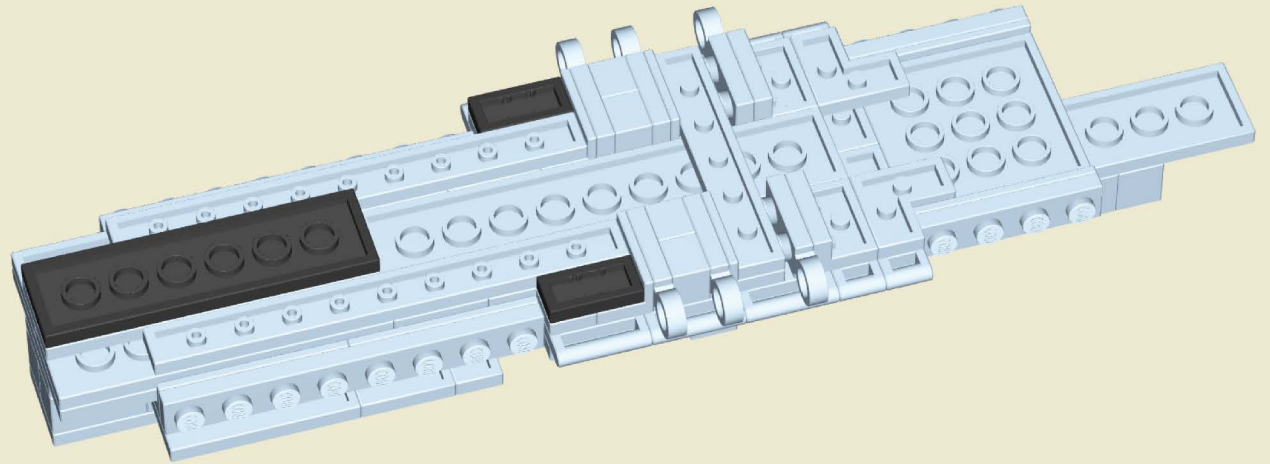

15

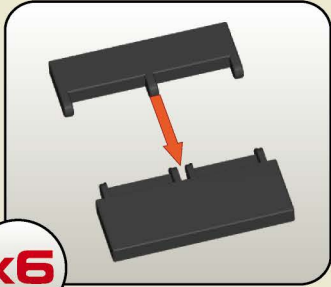
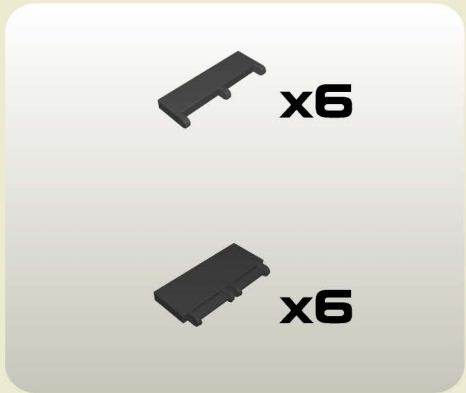
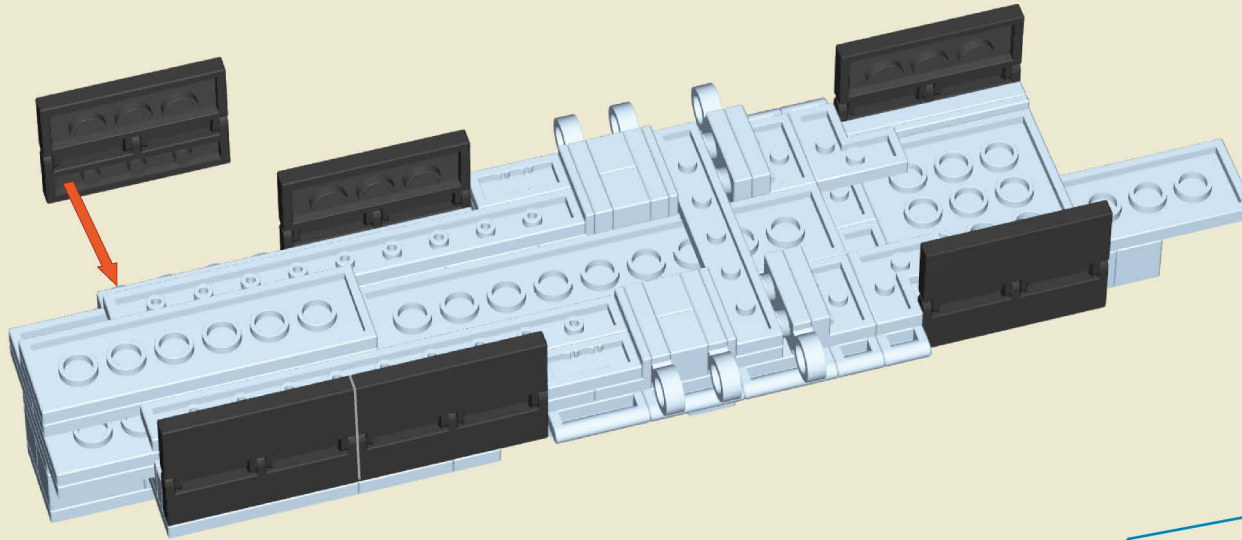

16

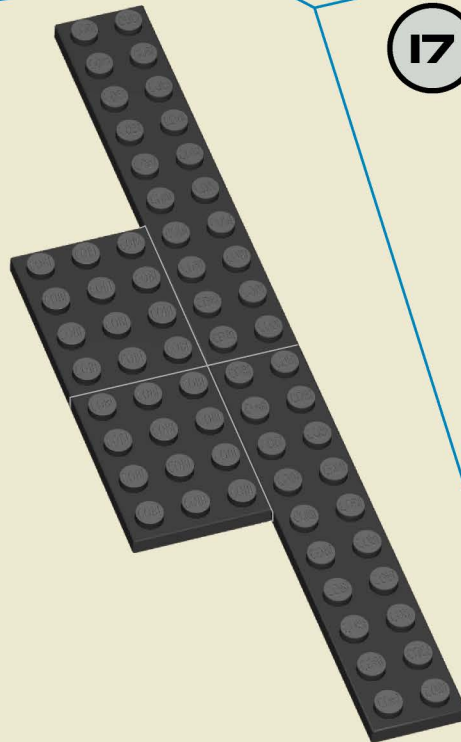
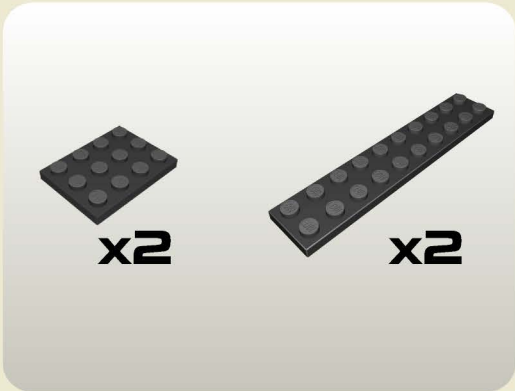

17

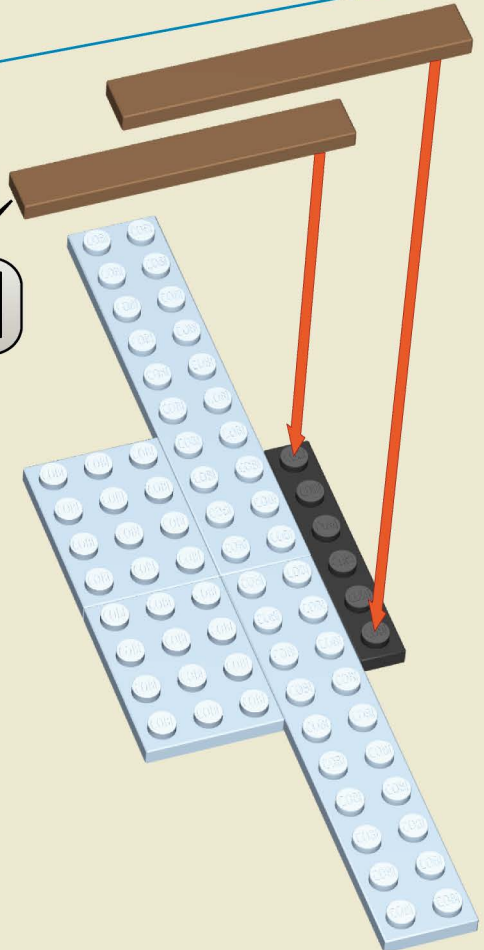
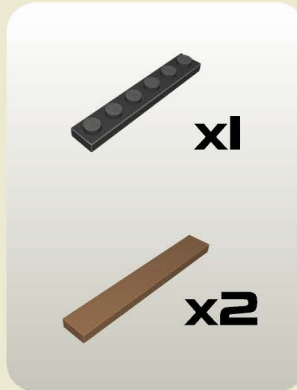

18

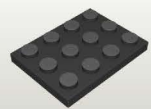
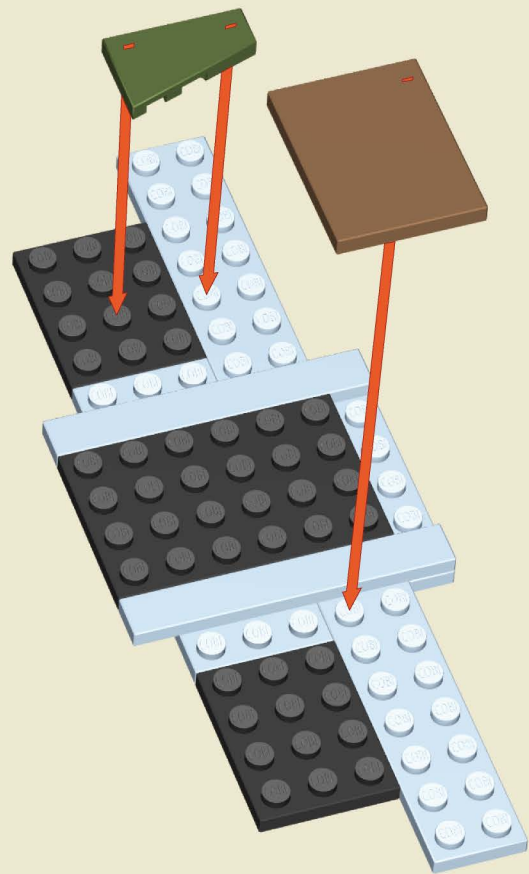

x2

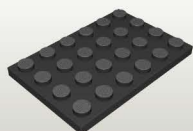

x1

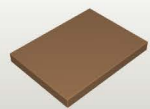

x1



x1

19

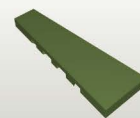
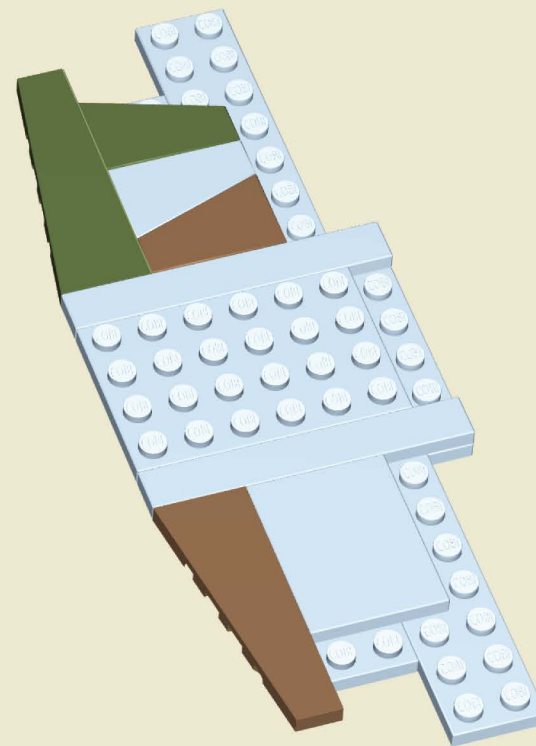

x1

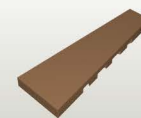

x1



x1



x1



20

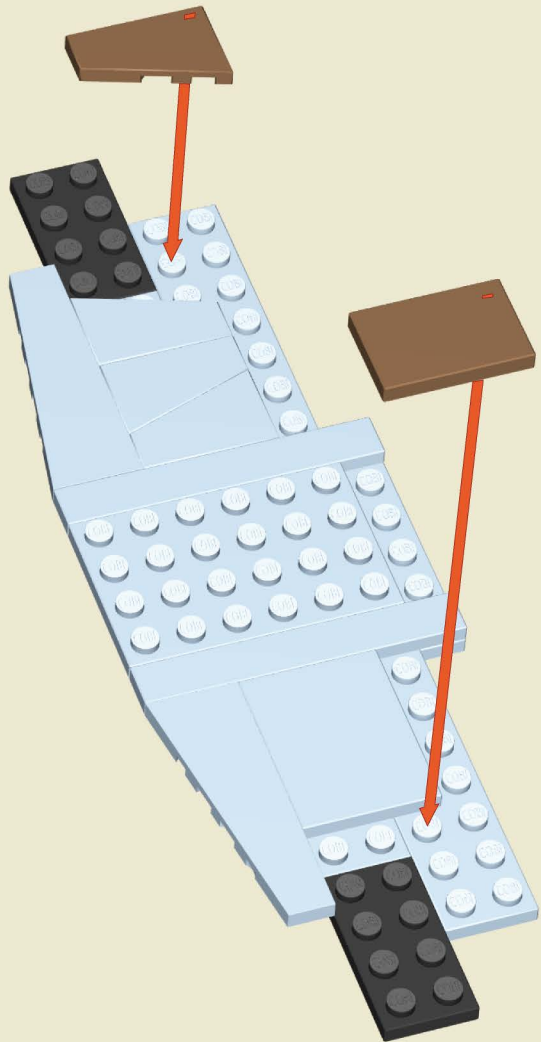

x2



x1



x1

21

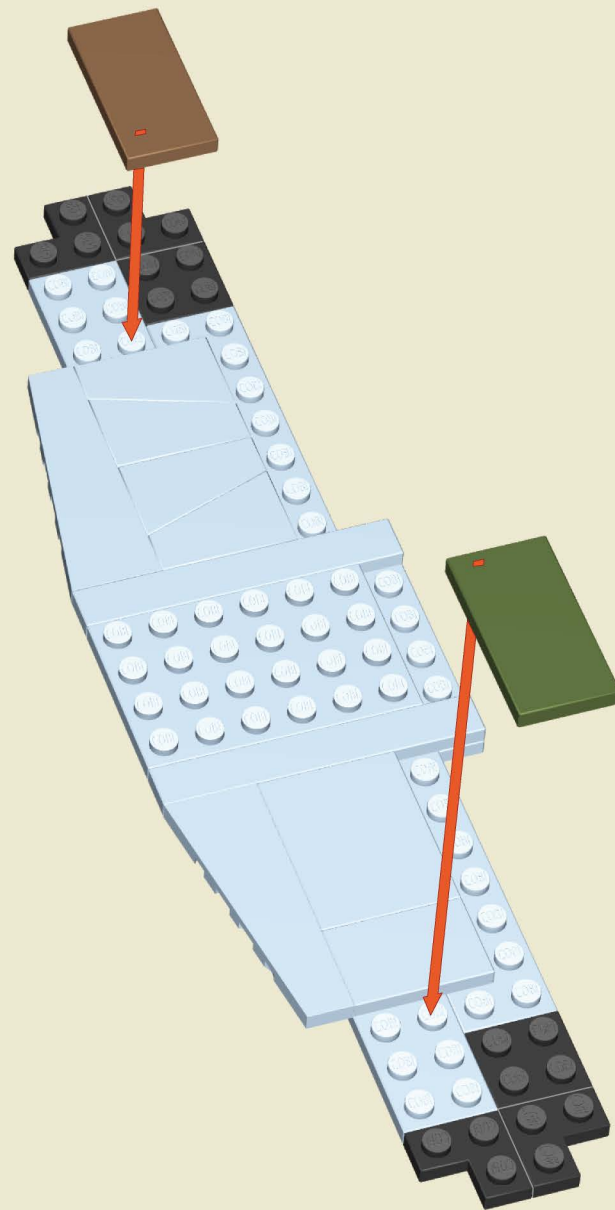

x4



x2

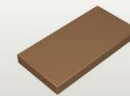

x1

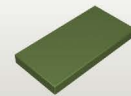

x1

22

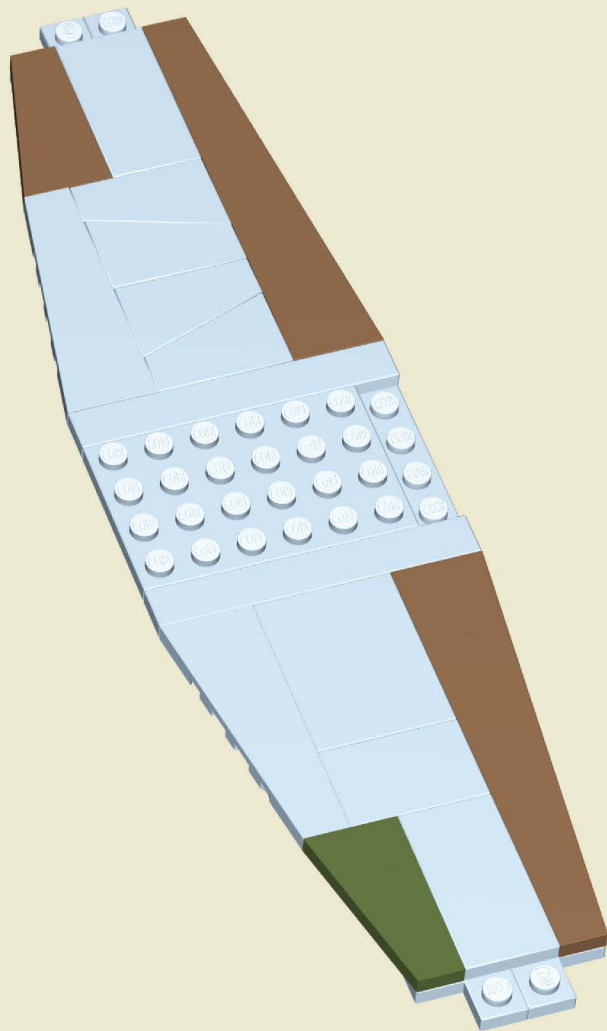

23

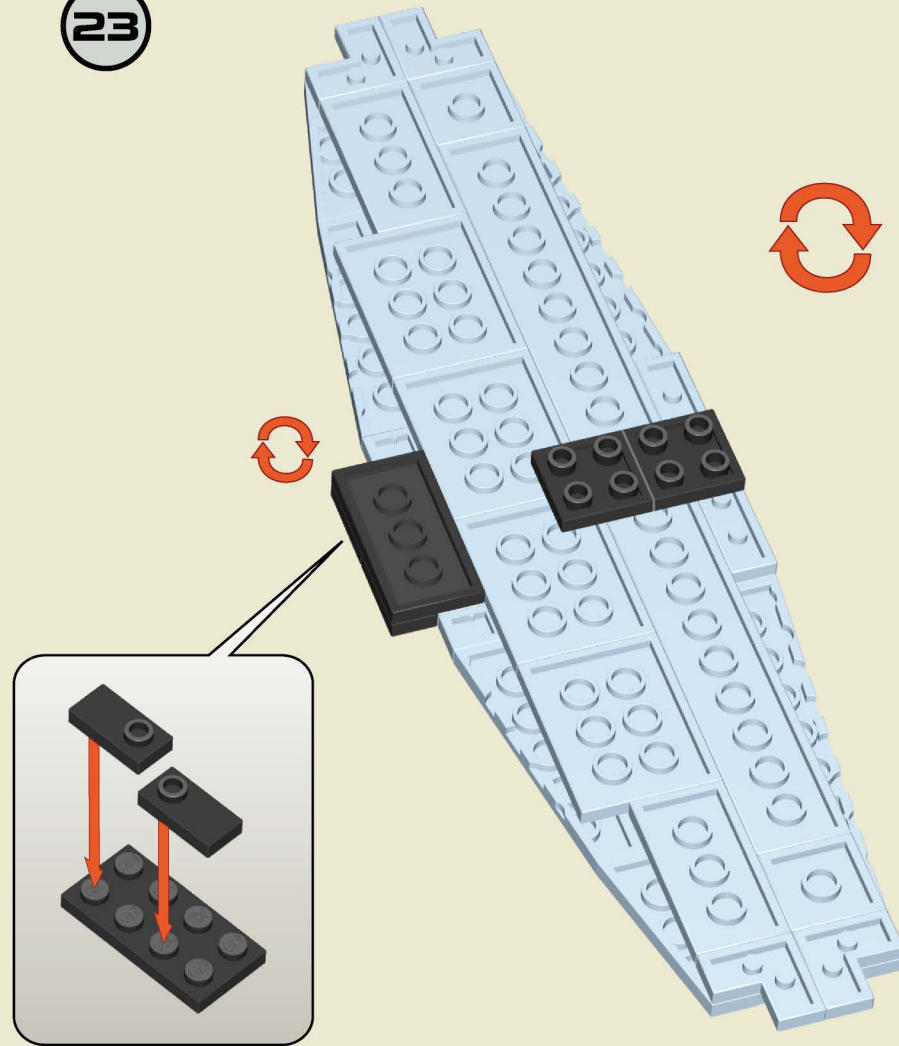

x1

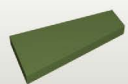

x1



x1



x1

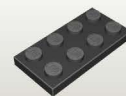

x1



x2



x2

24

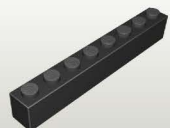
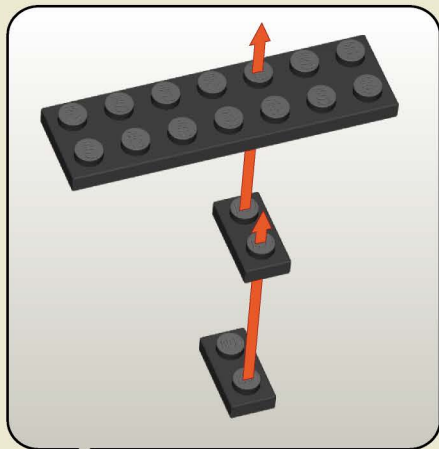
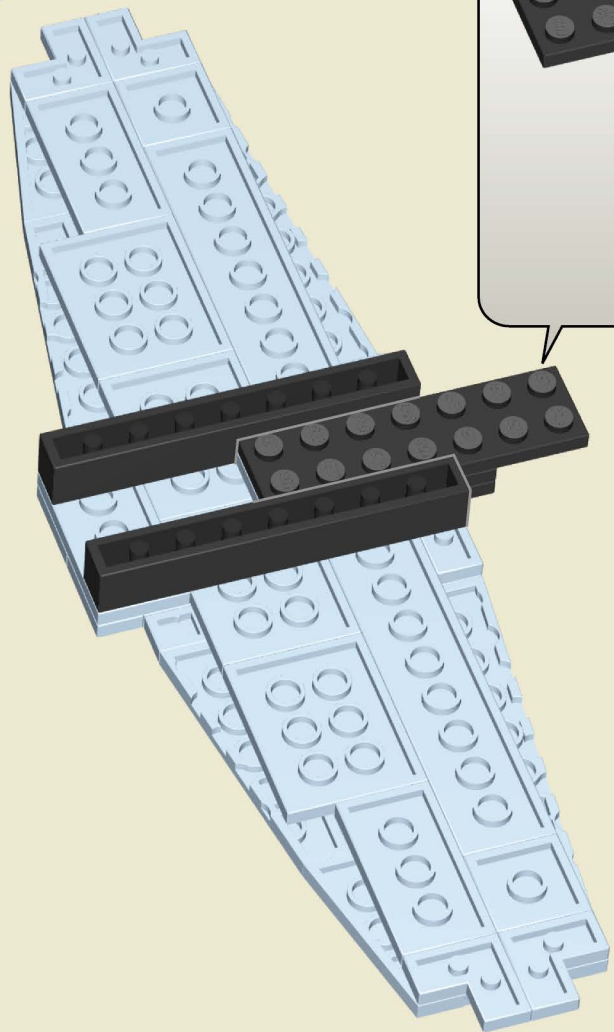

x2



x1



x2

25

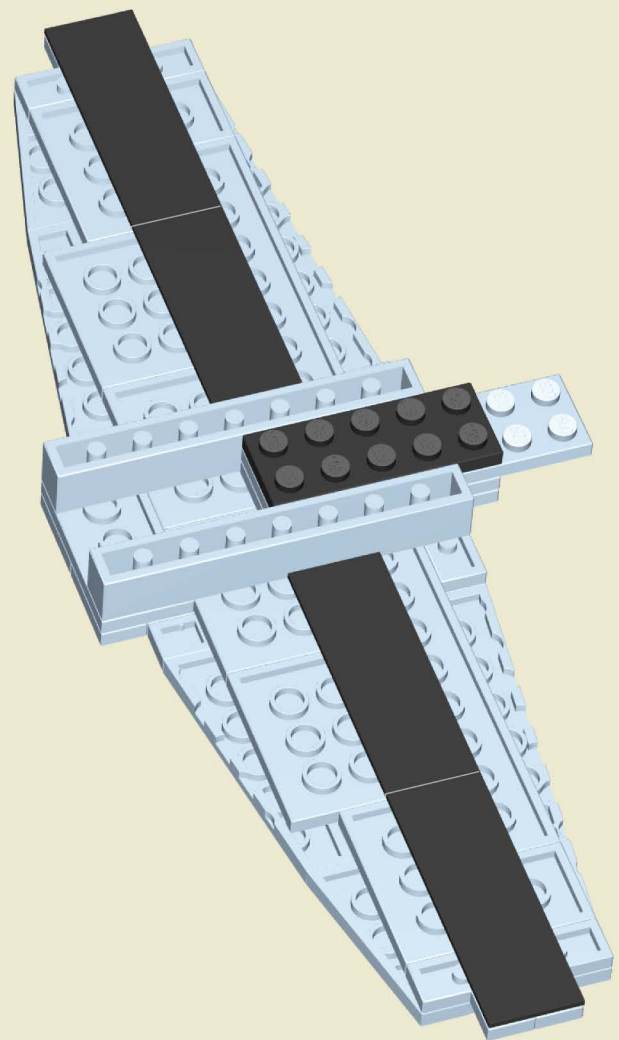

x4



x1



26

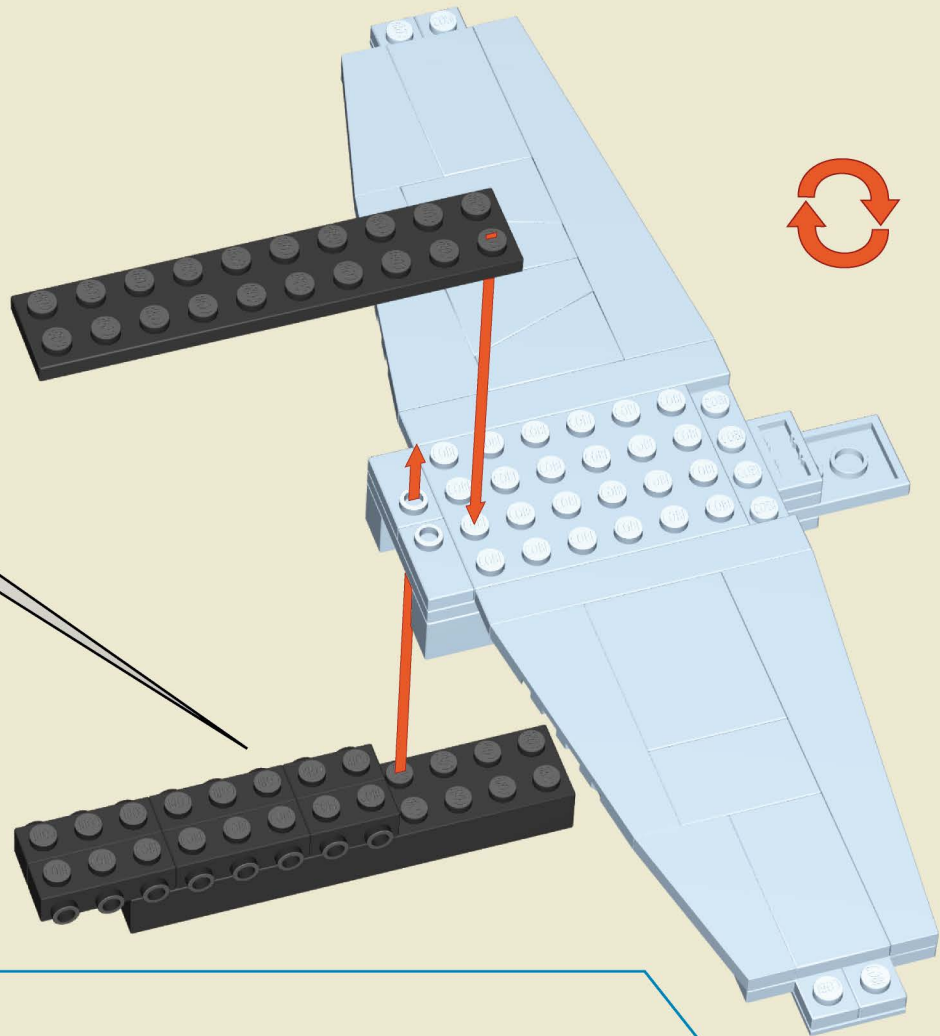
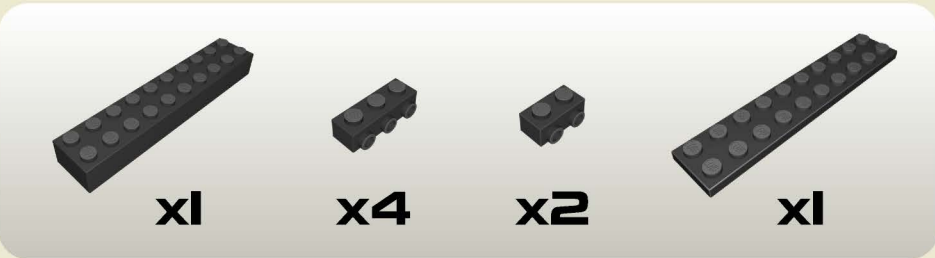
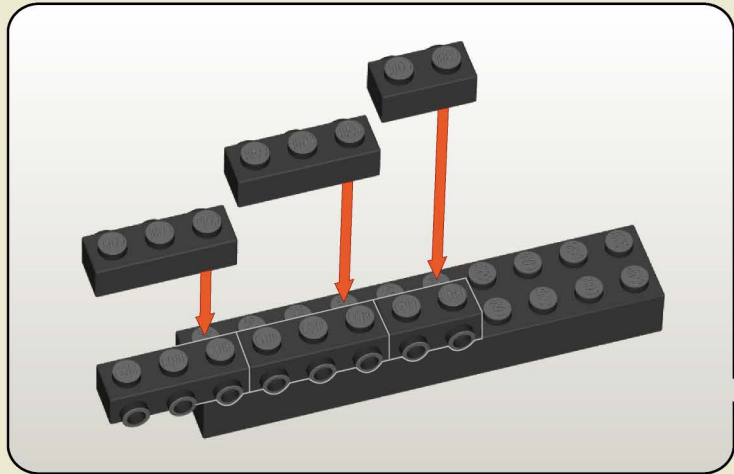

27

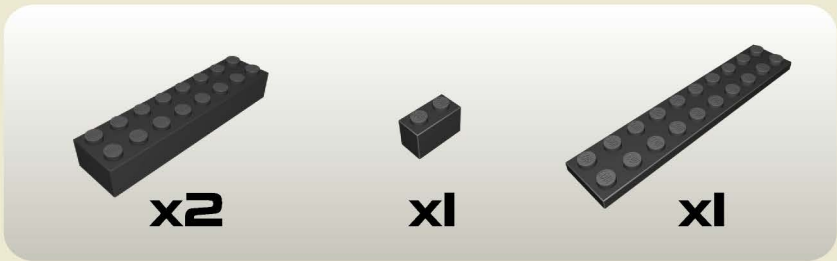
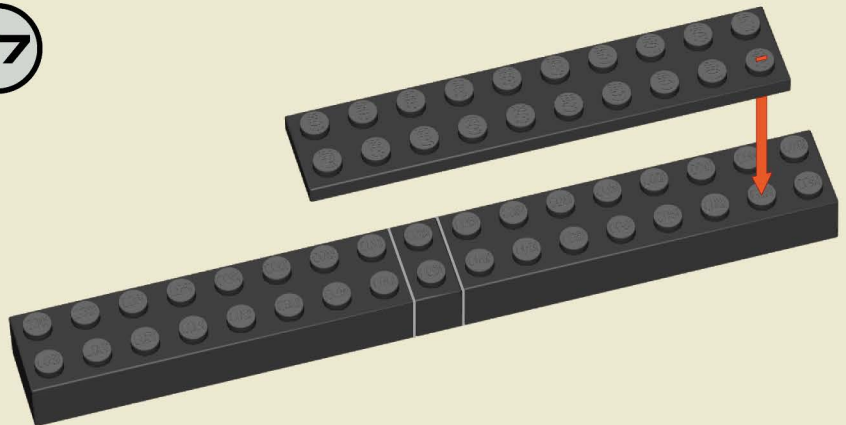

28

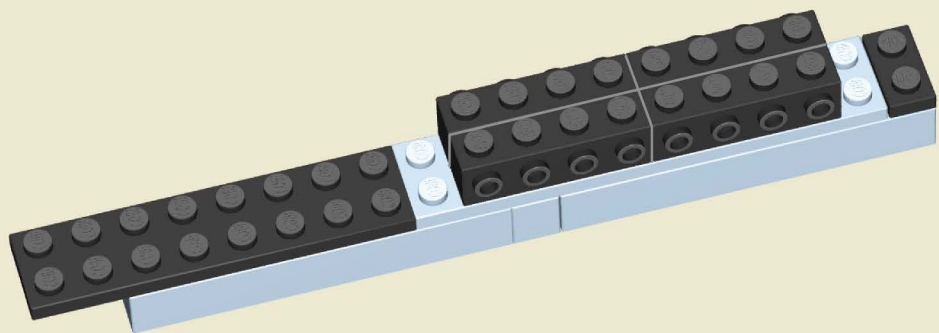

x1



x4



x1

29

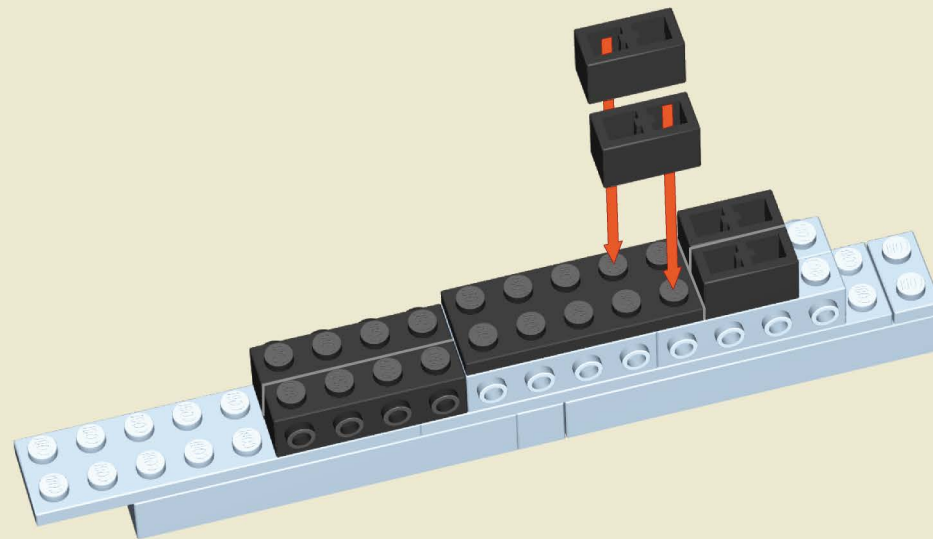

x2



x1



x4

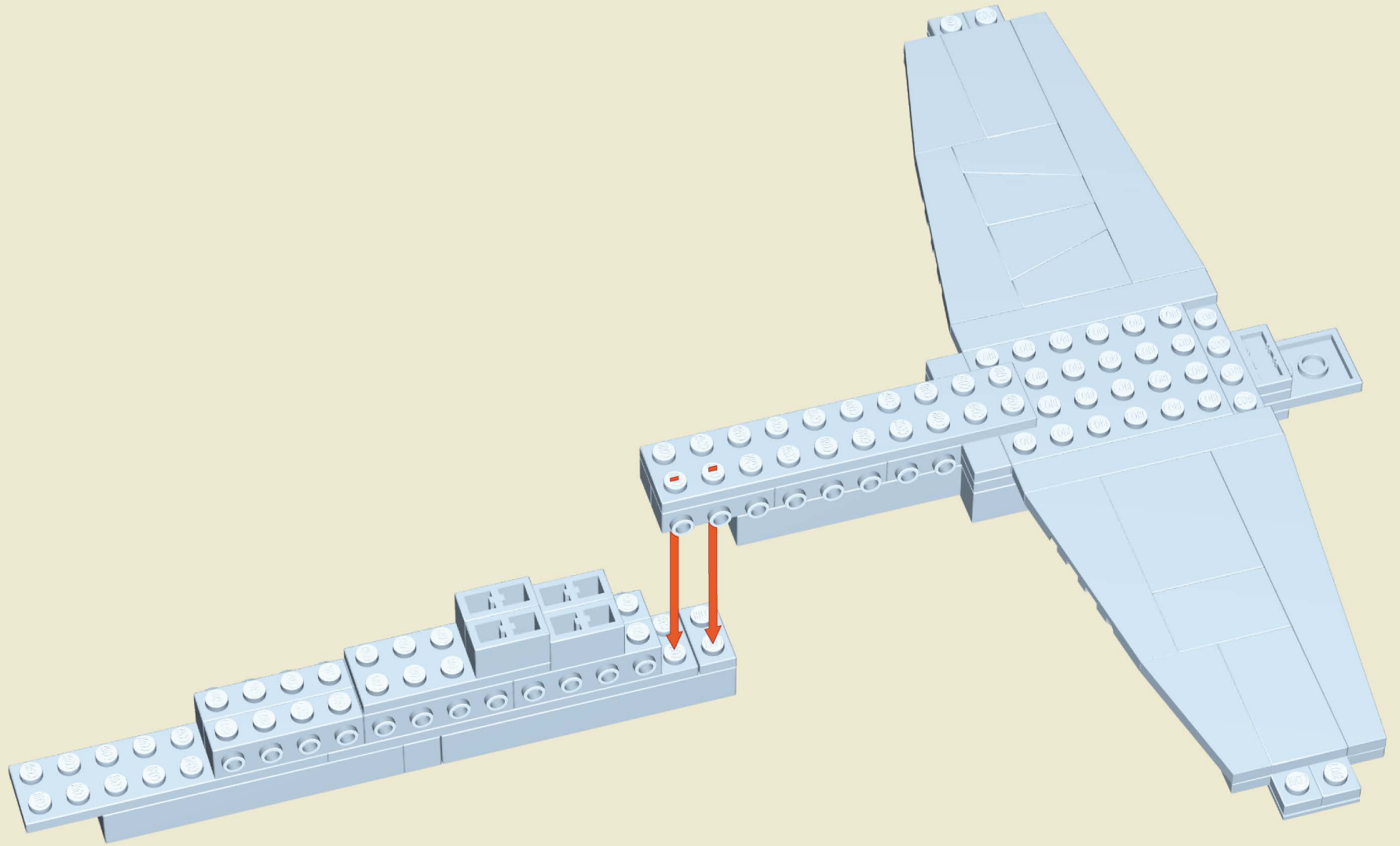



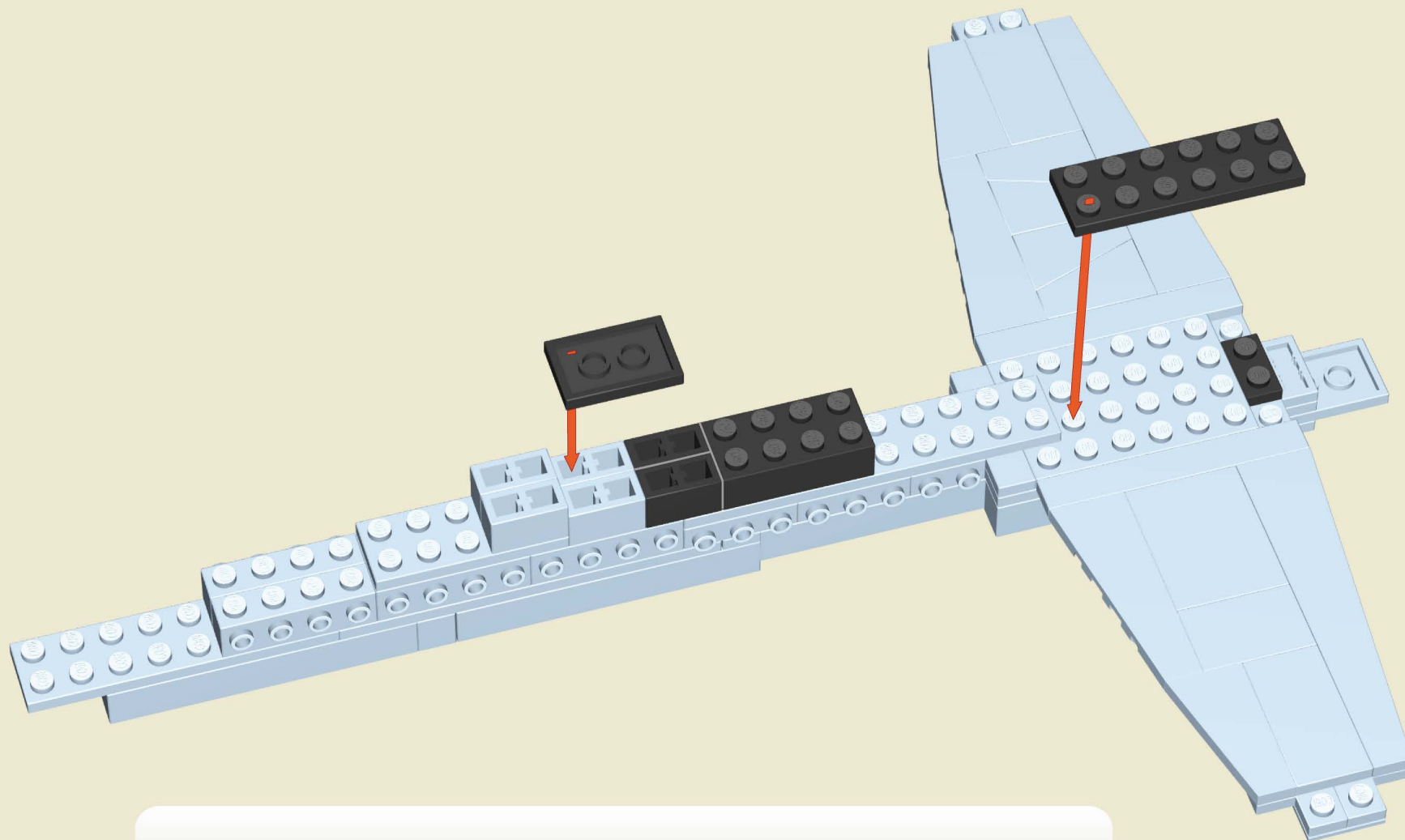

x2

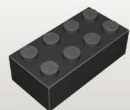

x1

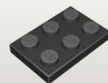

x1



x1



x1

32

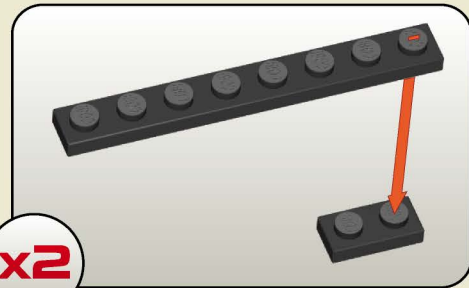
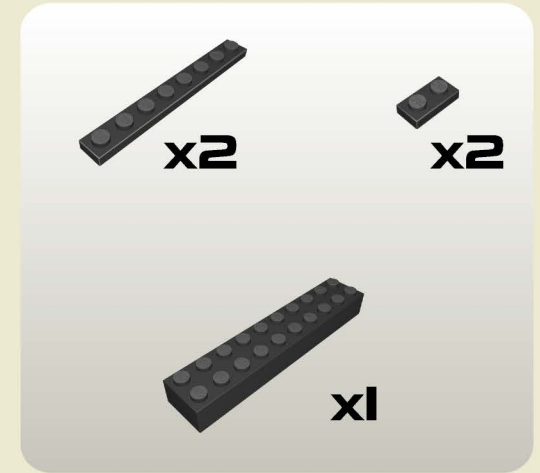
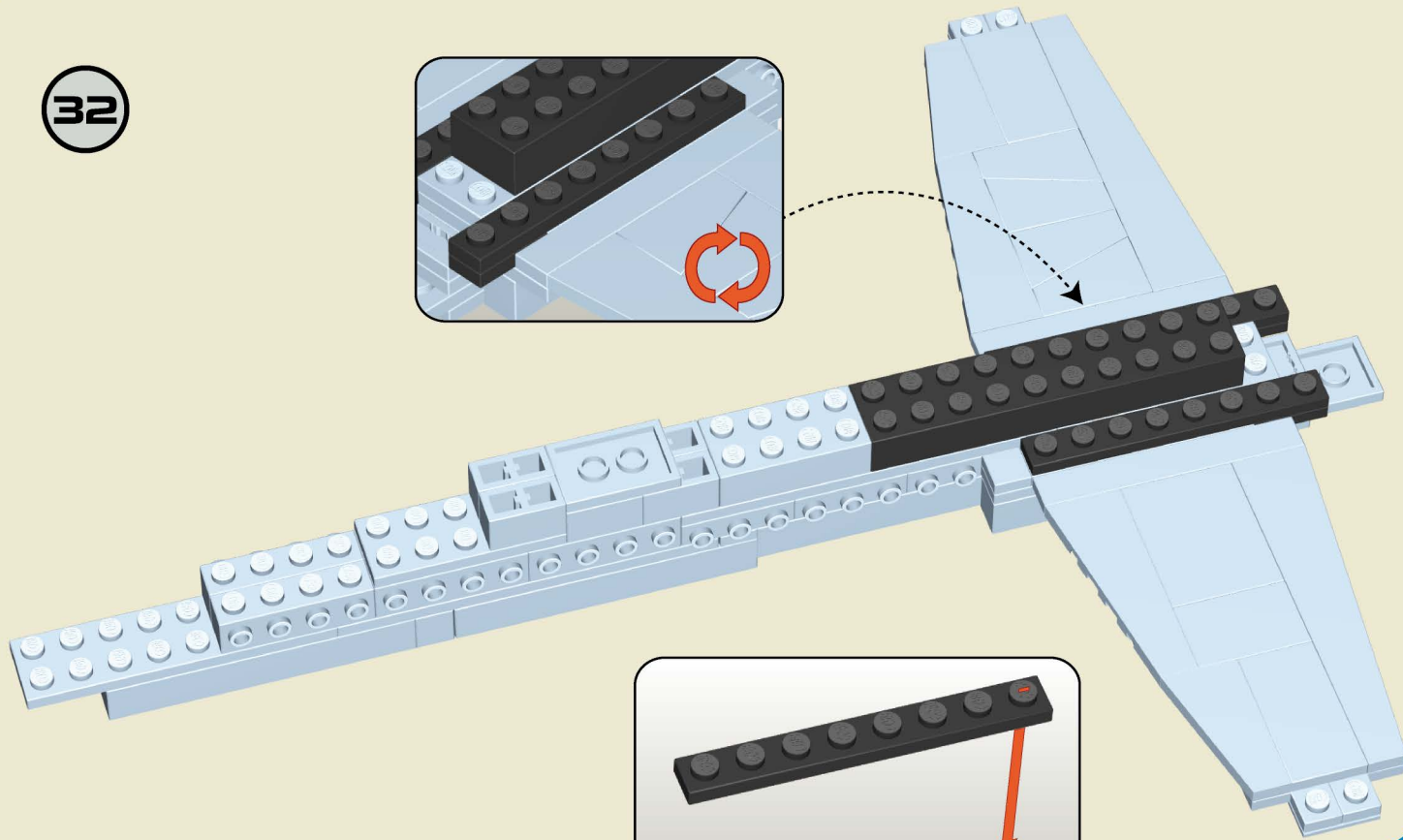
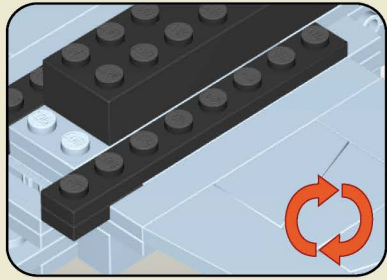

x2

33

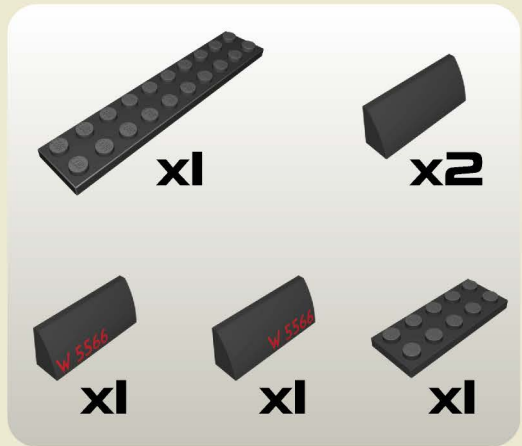
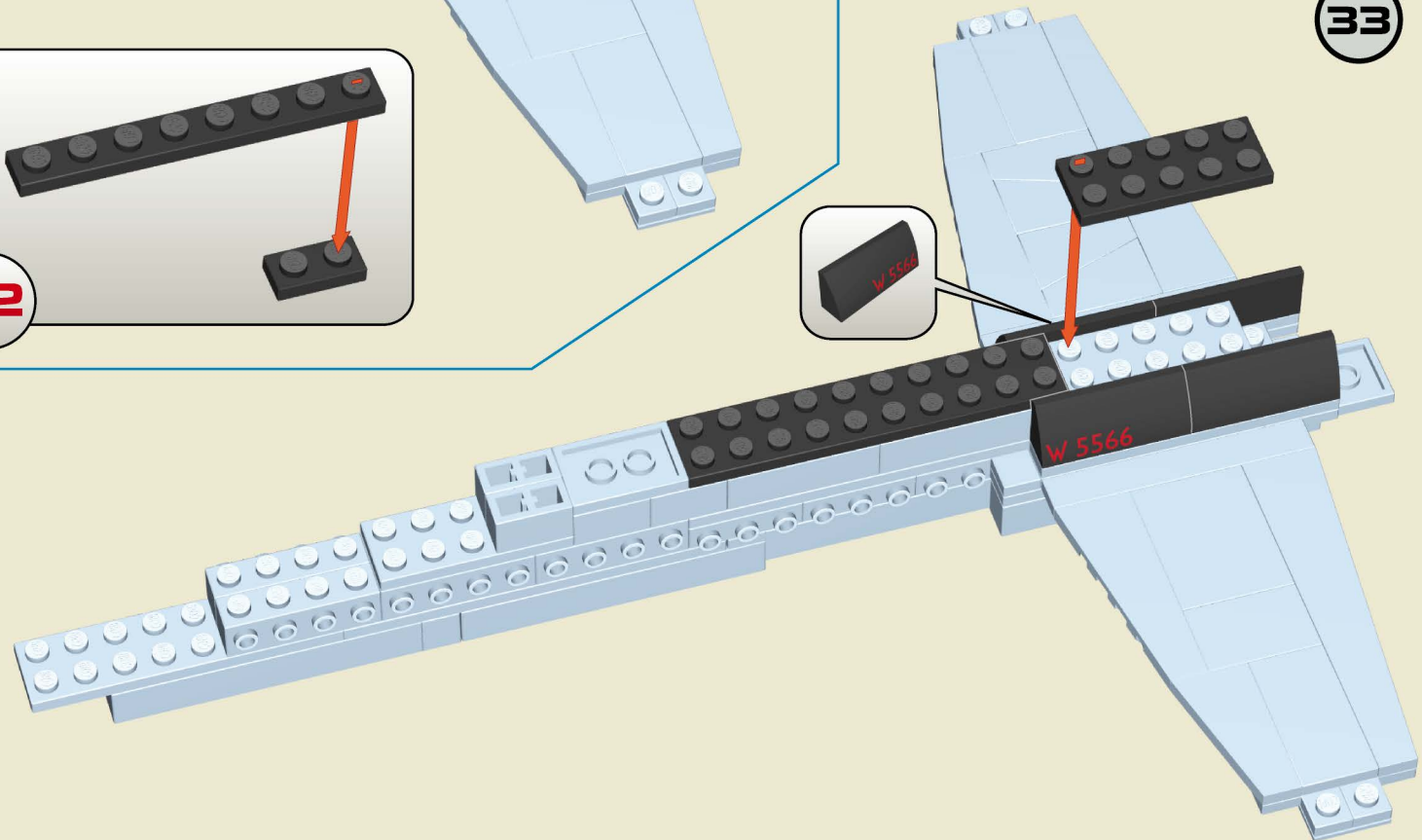

34

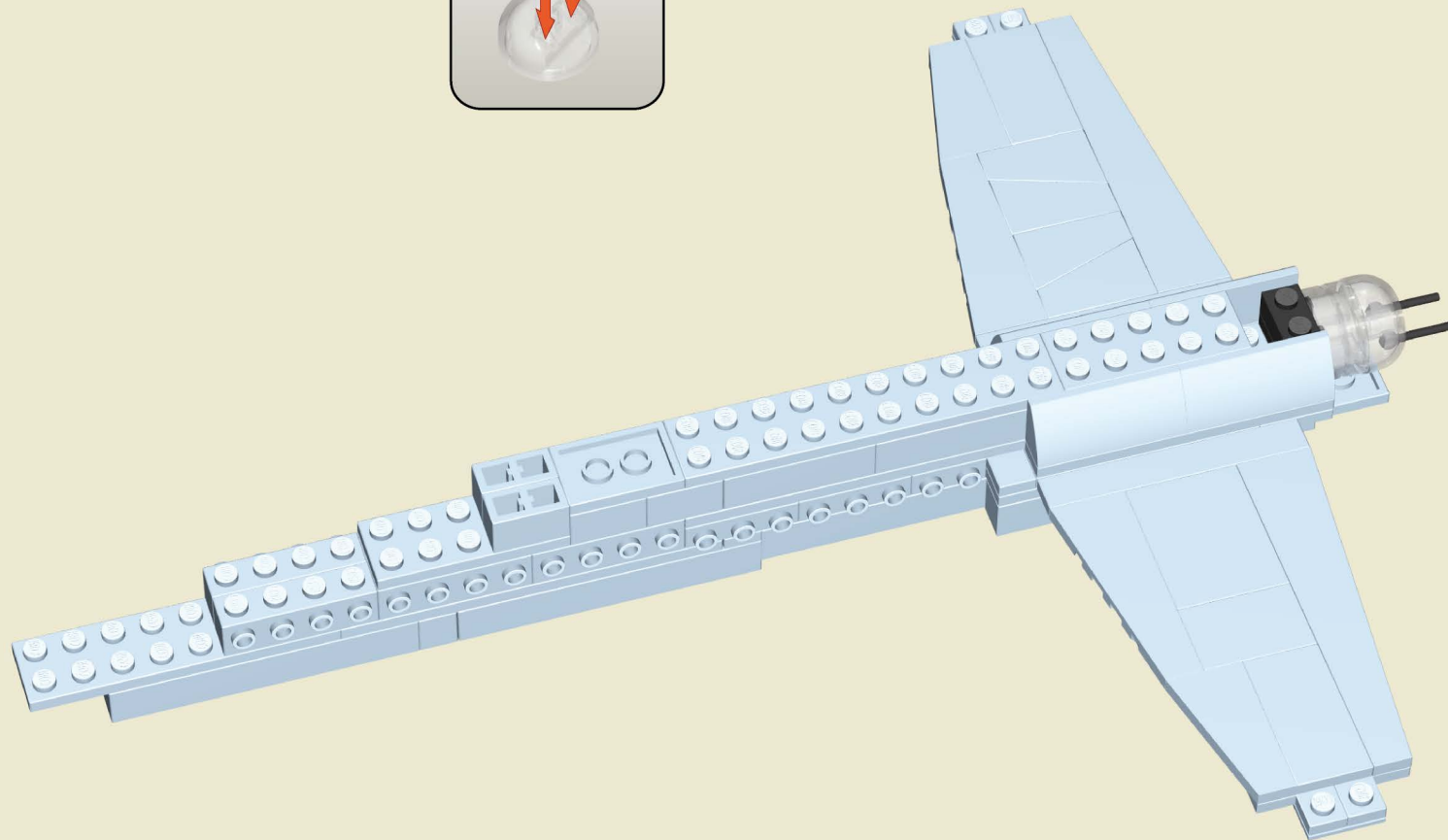
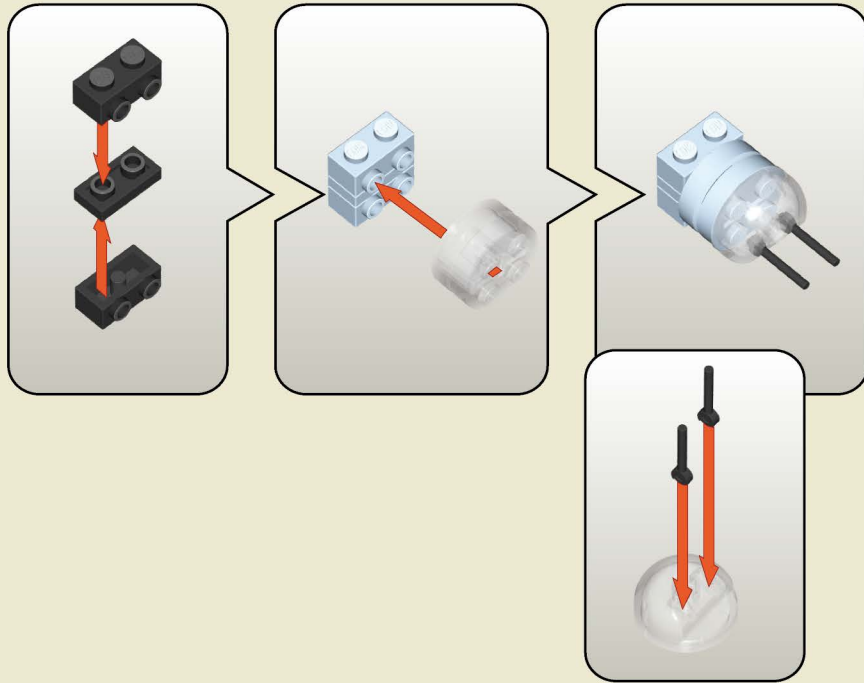



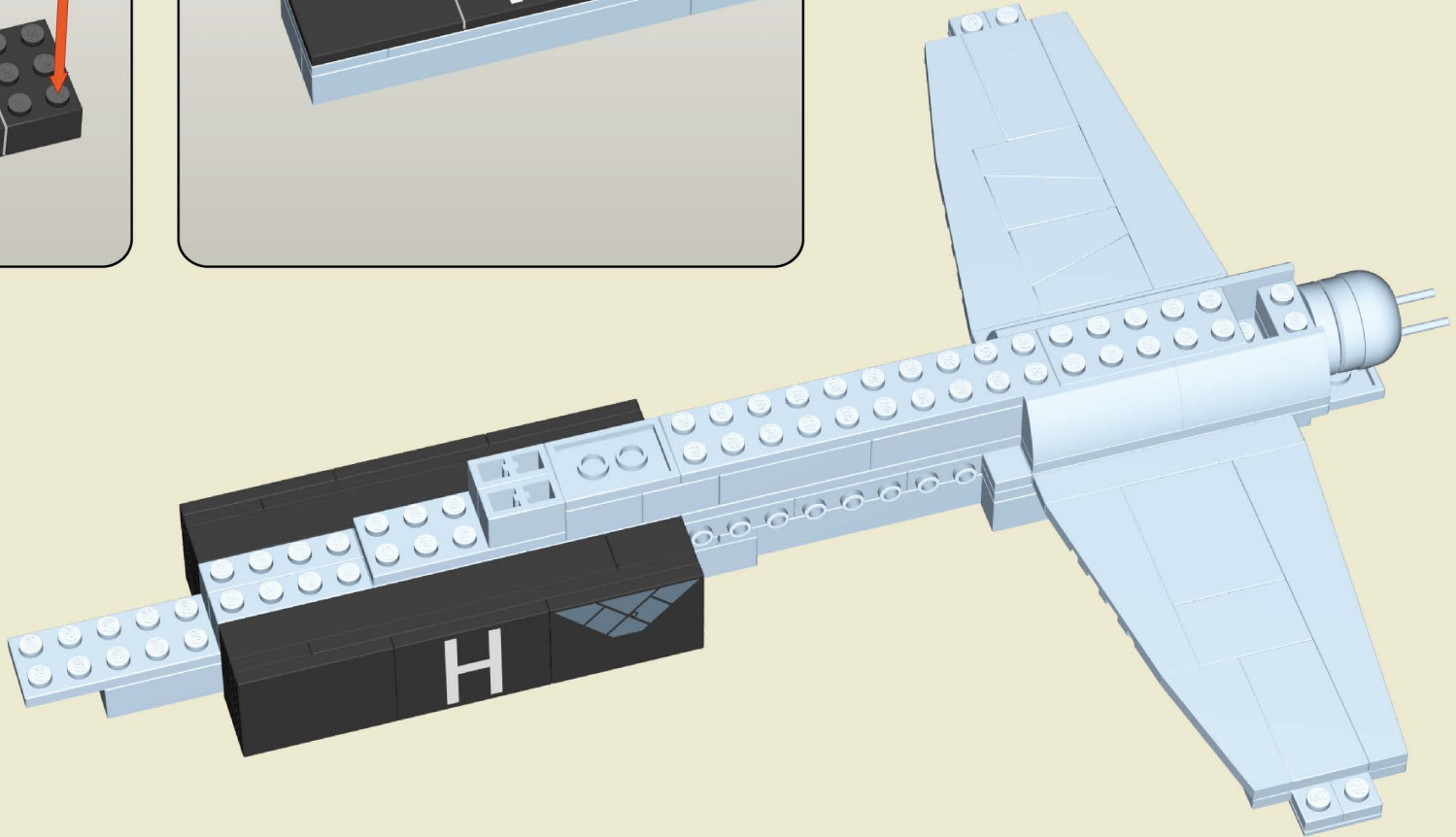
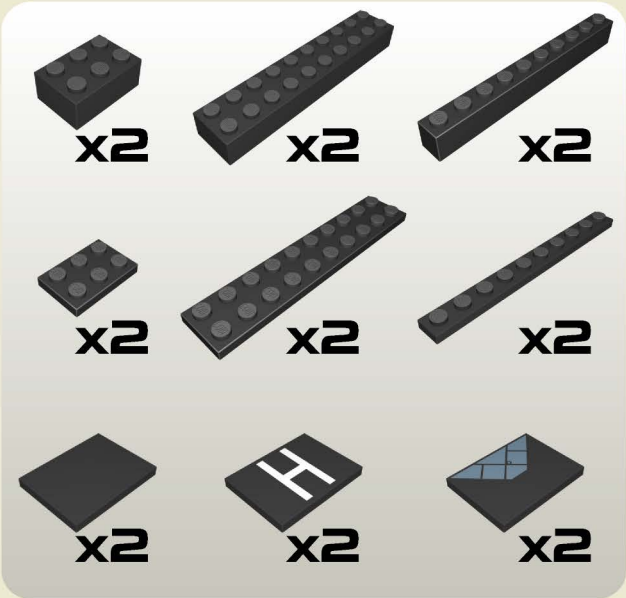
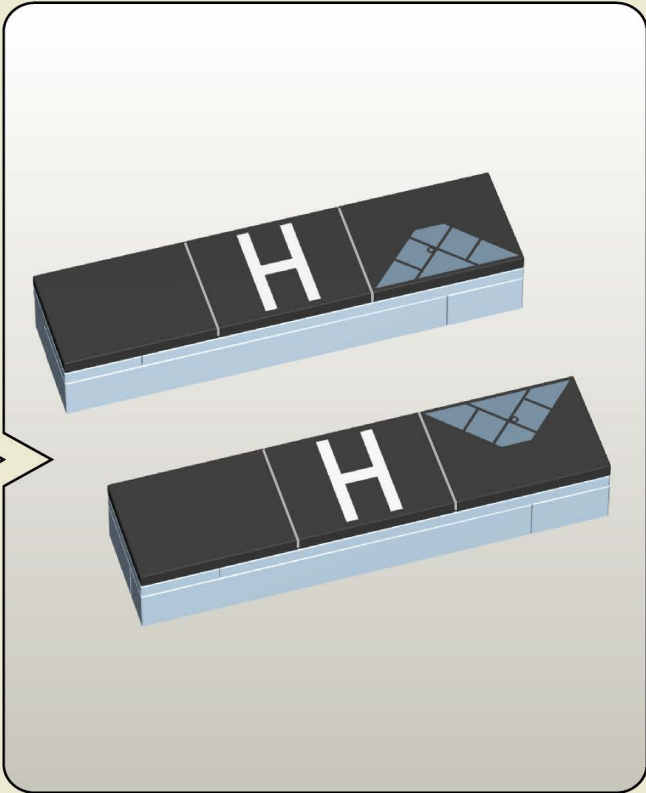
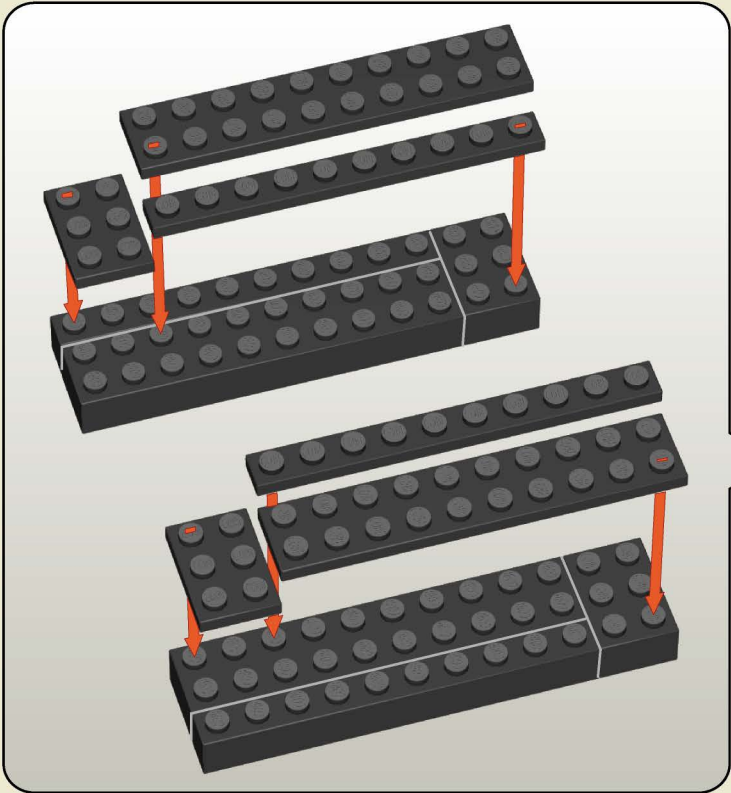

36

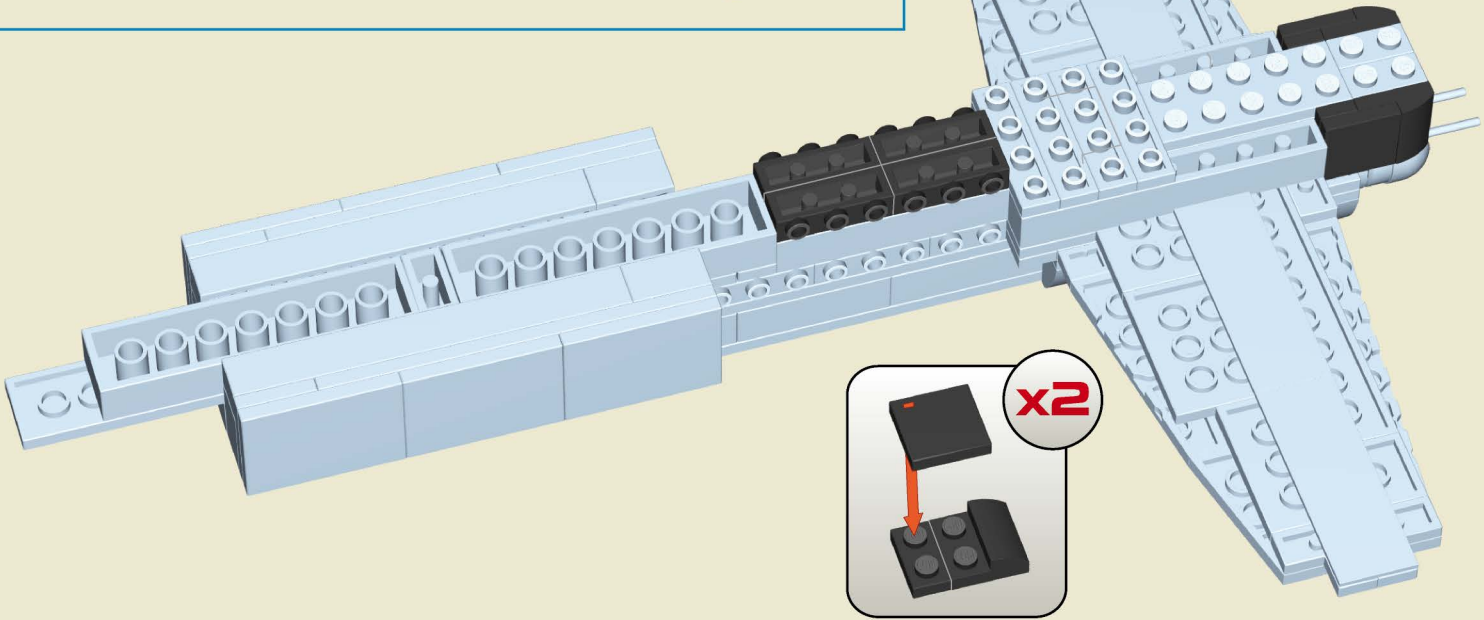
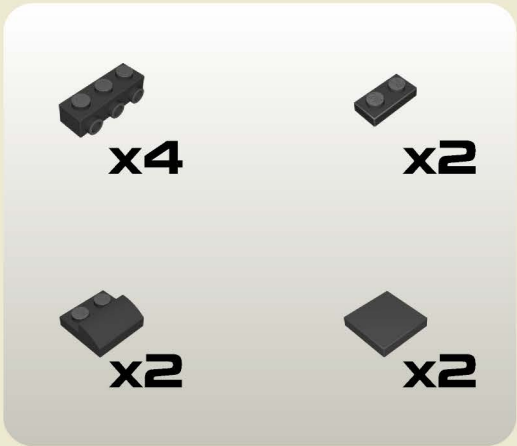
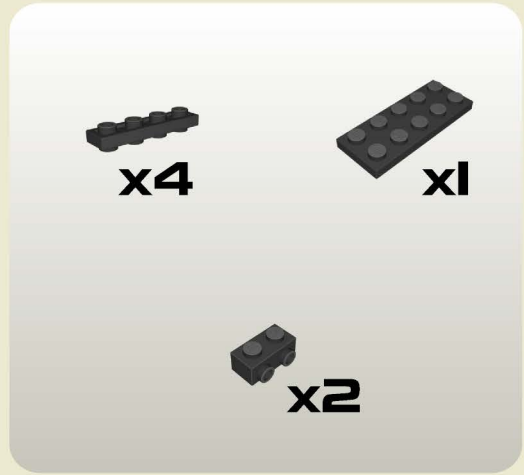
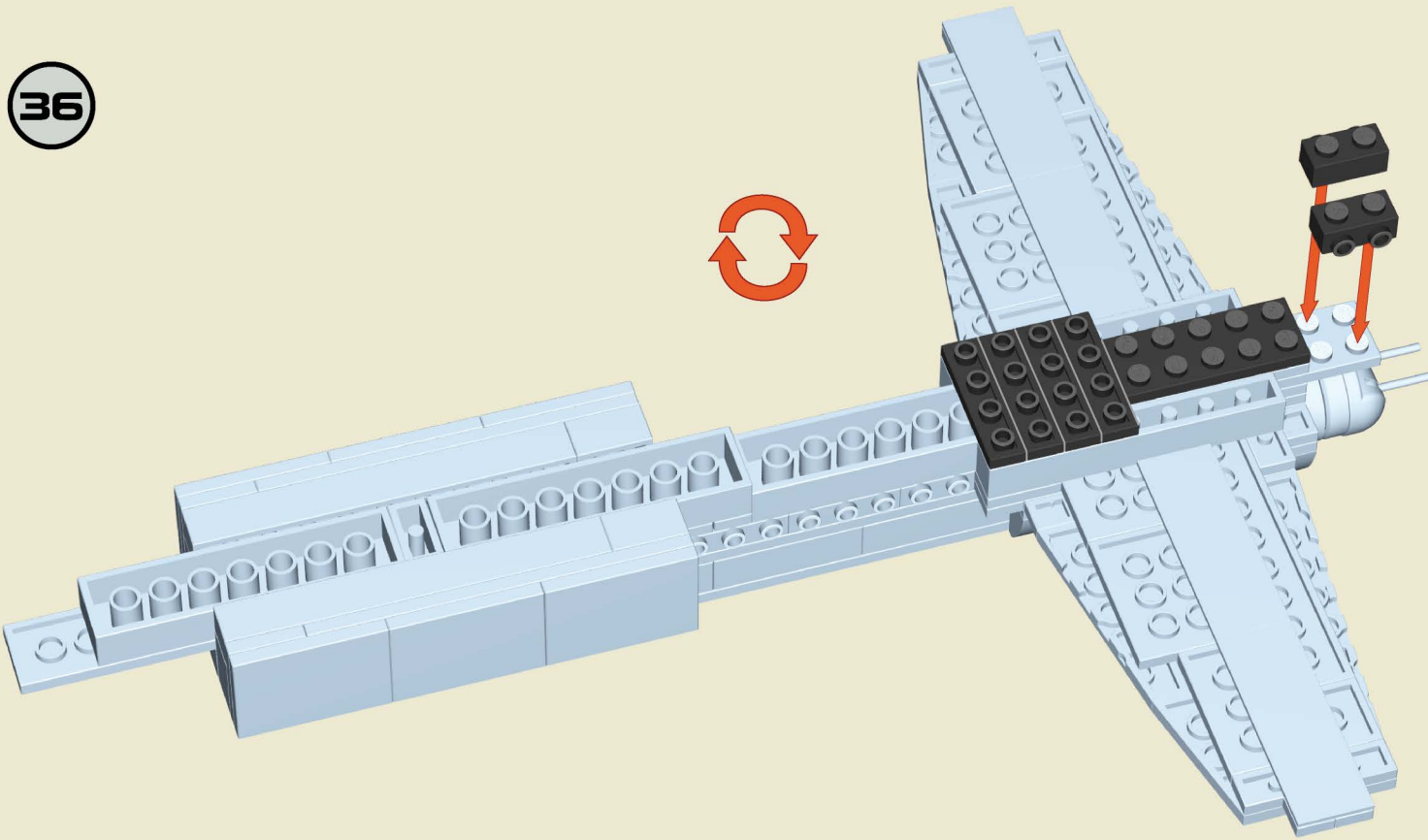

38

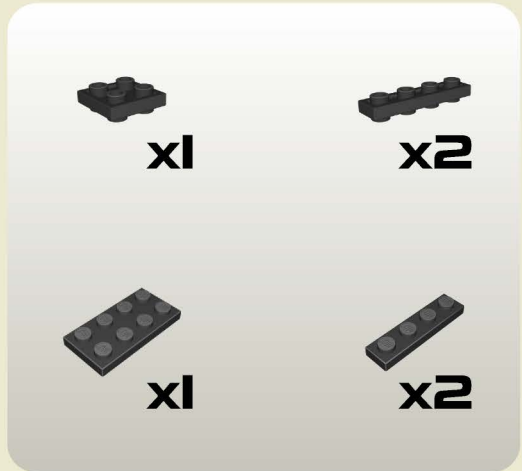
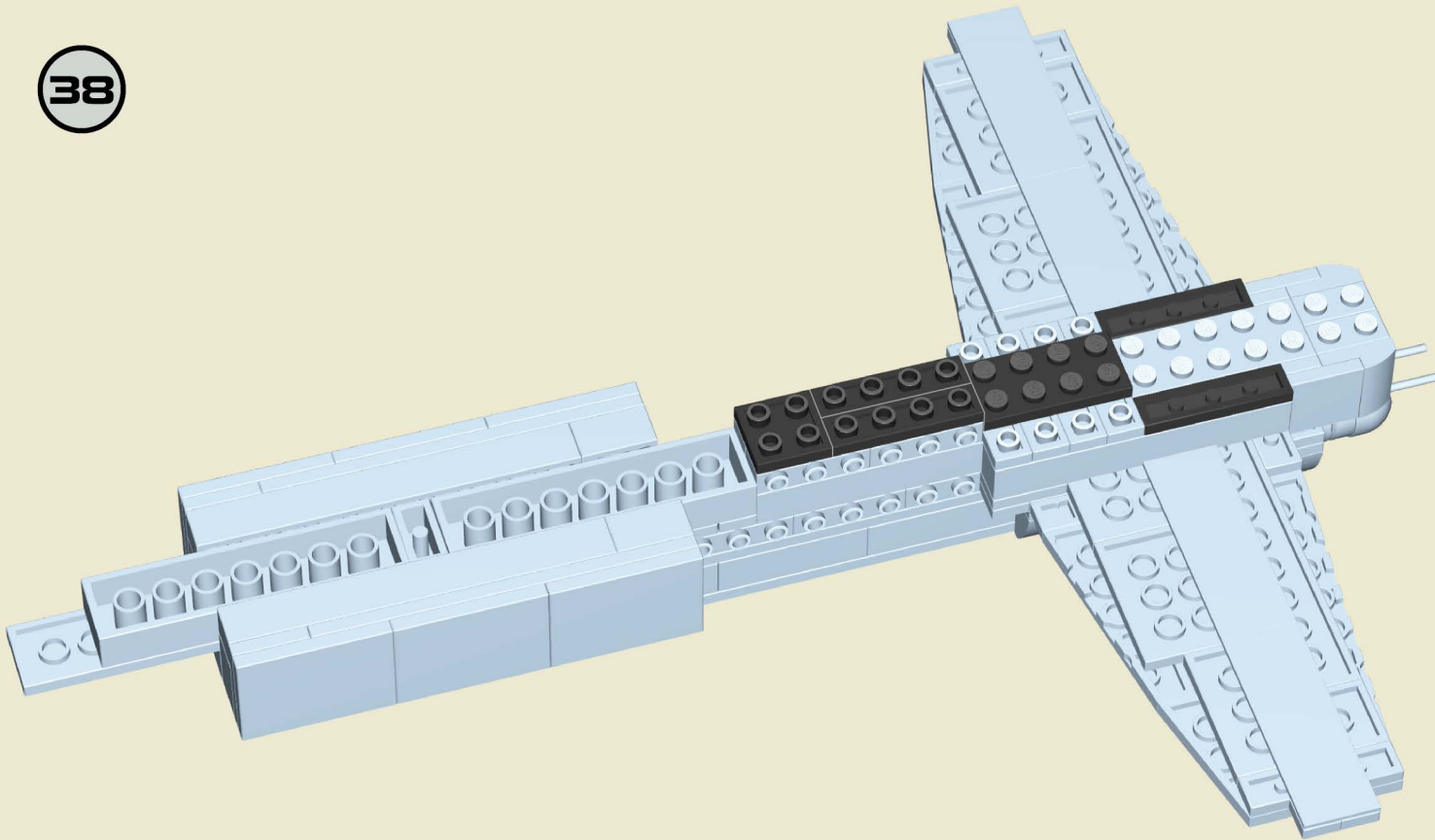

39

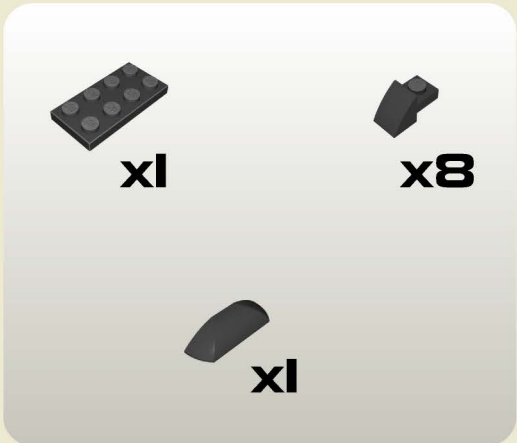
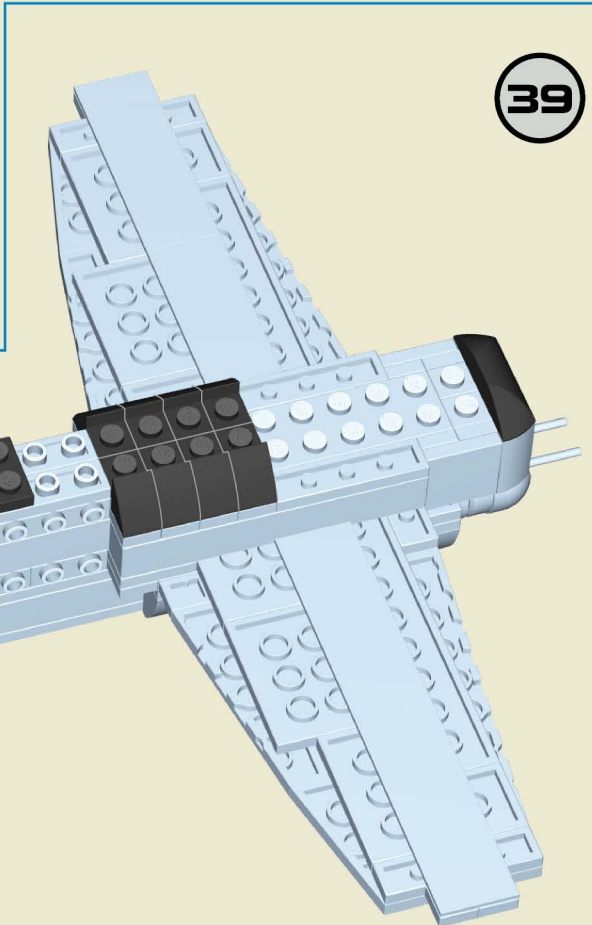



40

1:1



x1

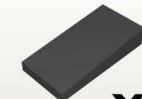

x1



x1



x1

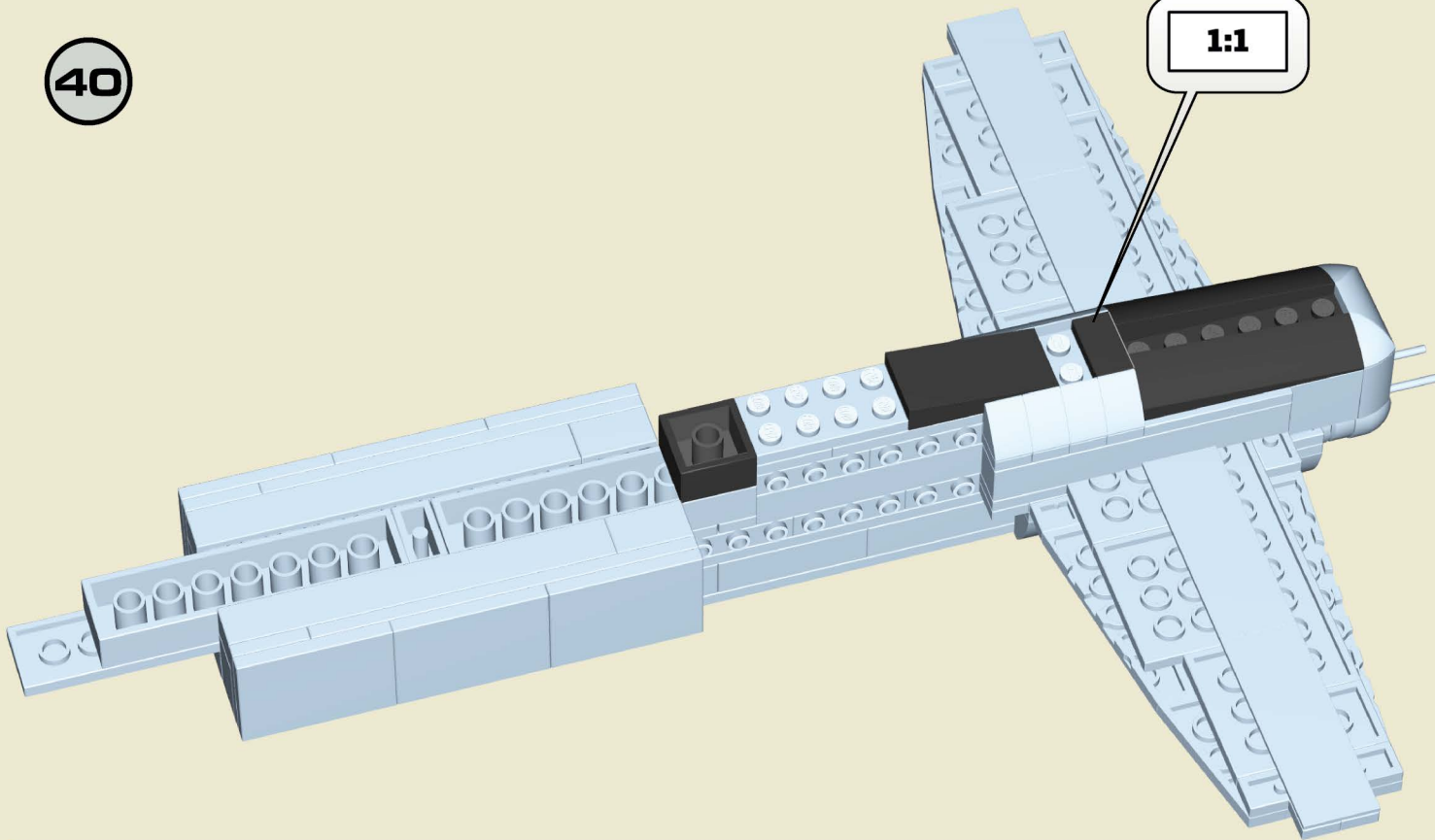

41

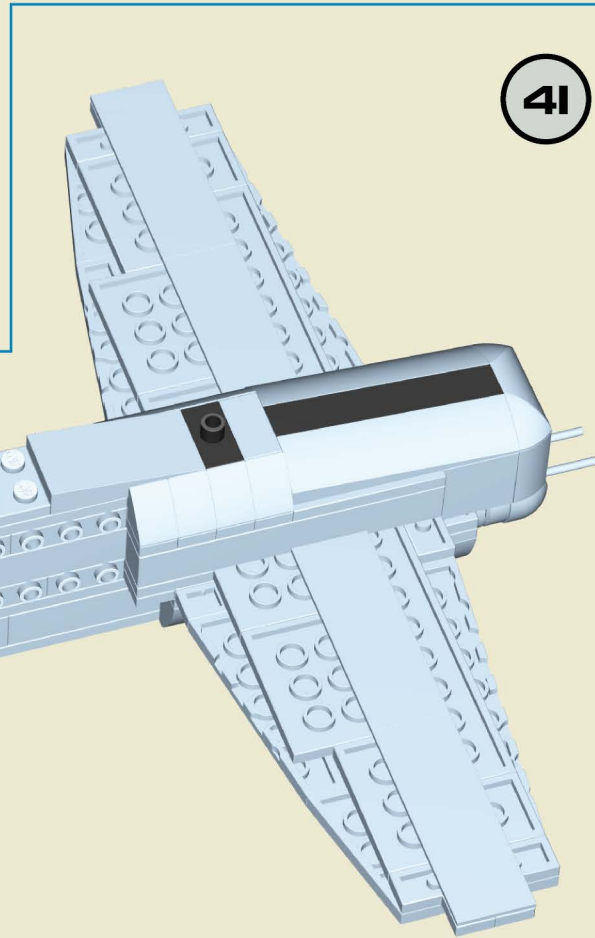

x6



x1



x1



x1

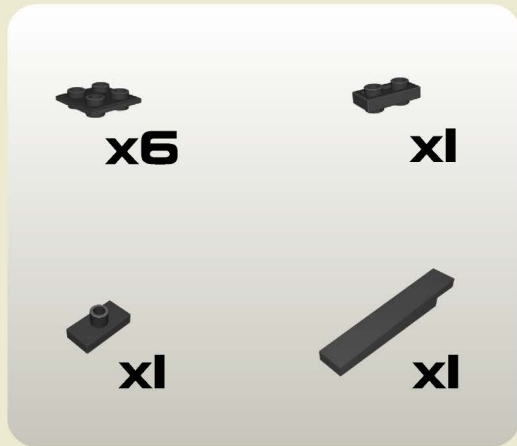

42

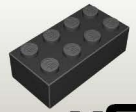
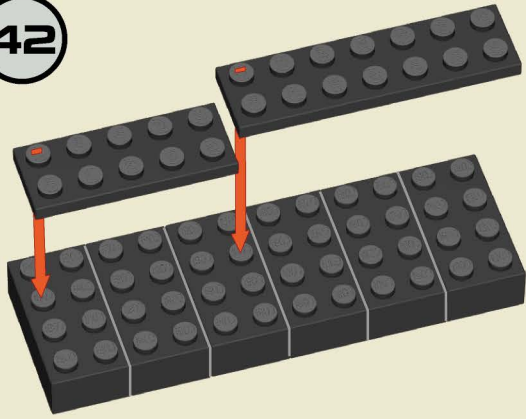

x6



x1



x1

43

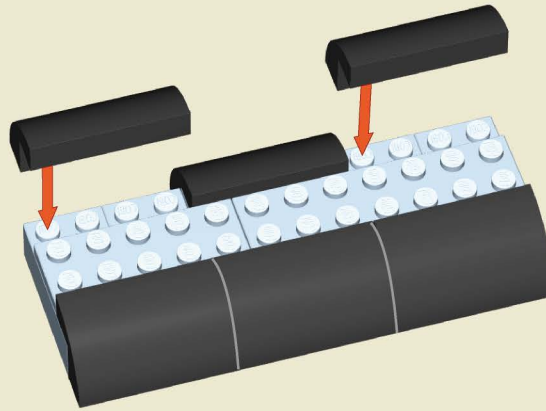

x6

44

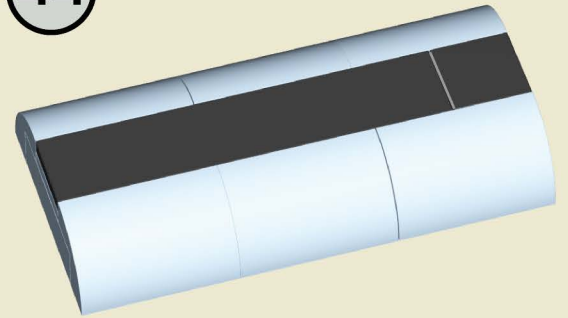

x1



x1

45



x2

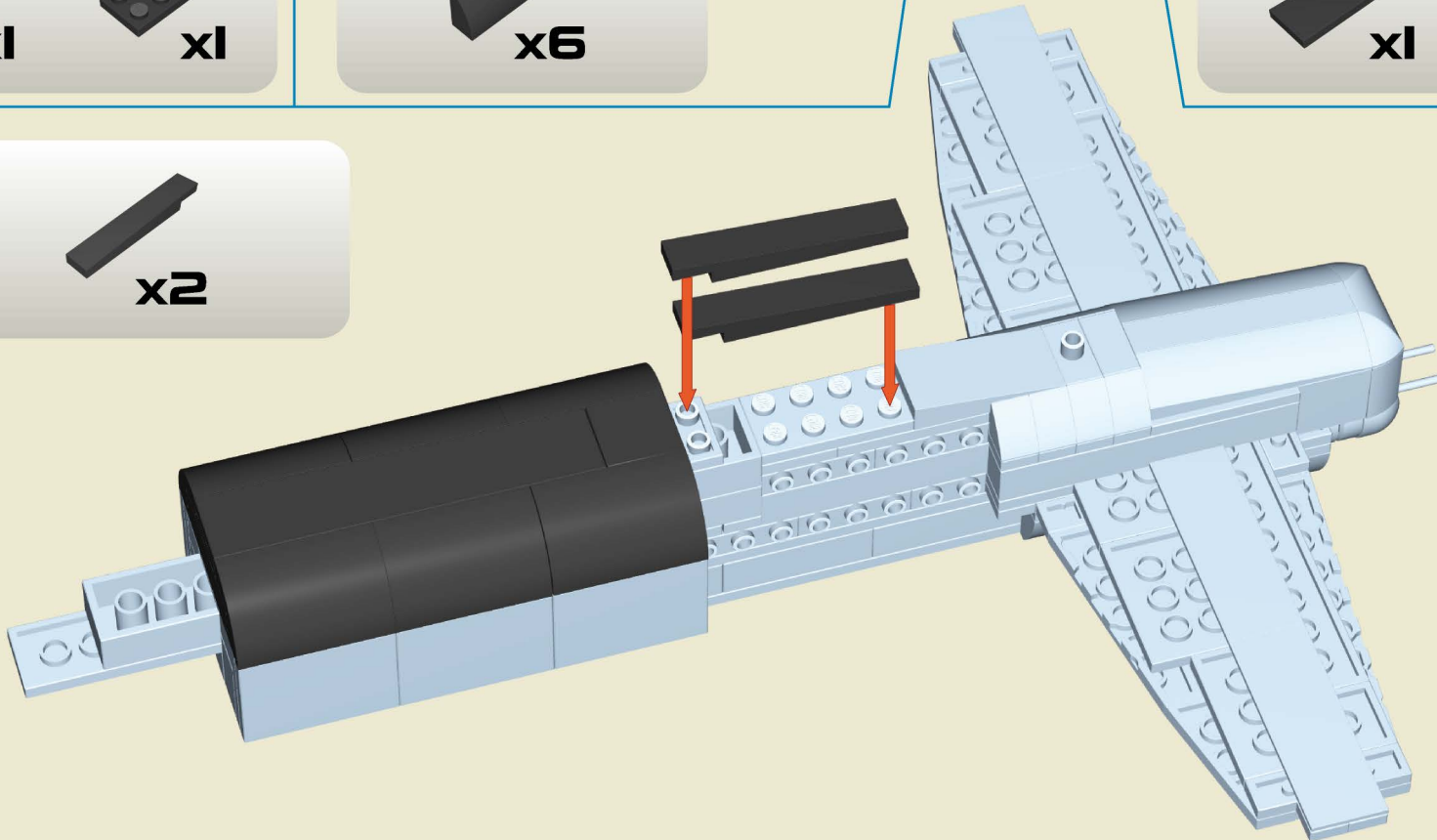

46

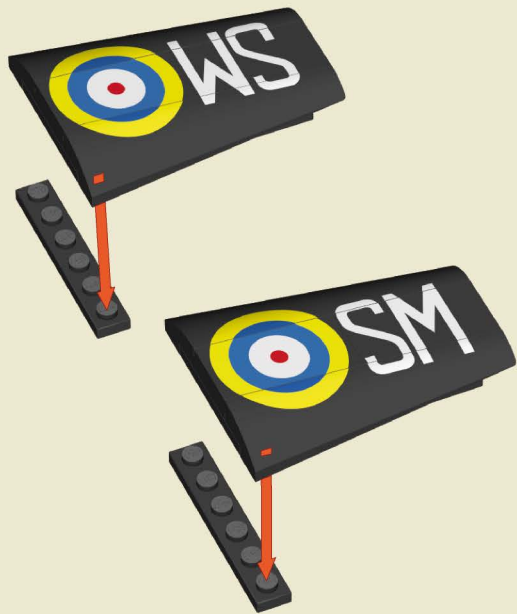

47

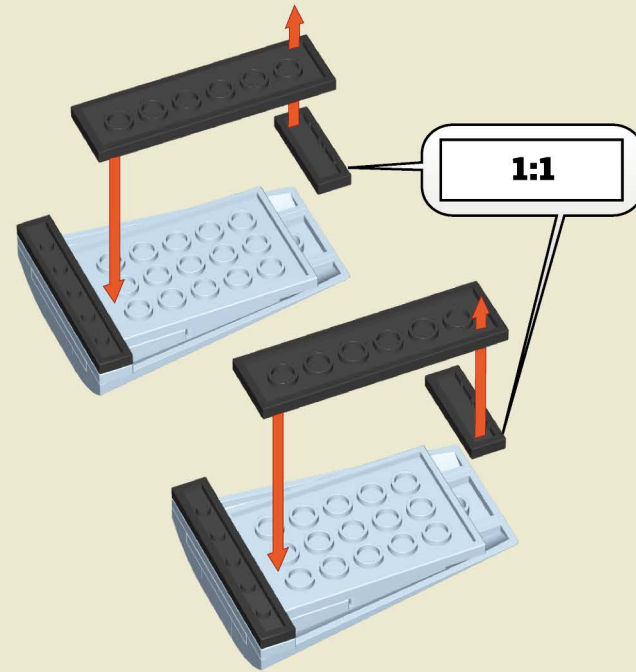

48

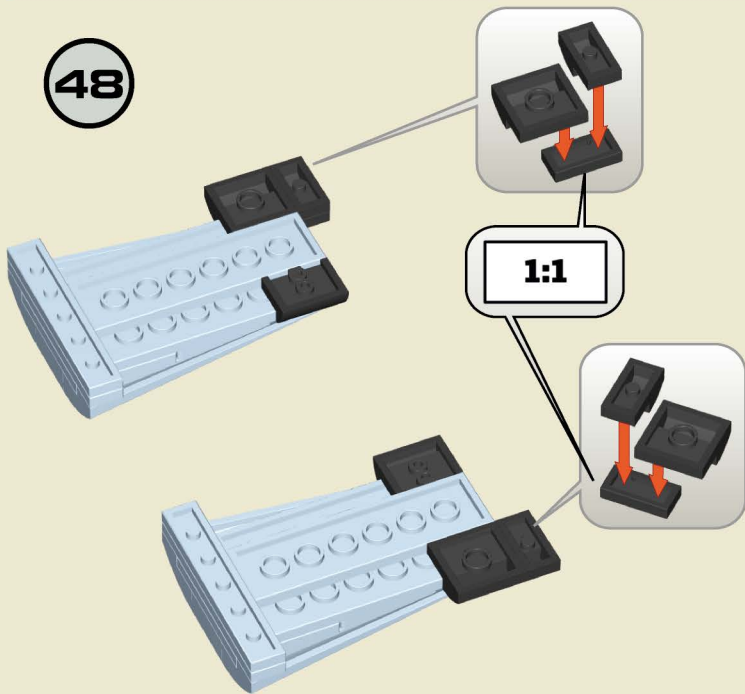

49

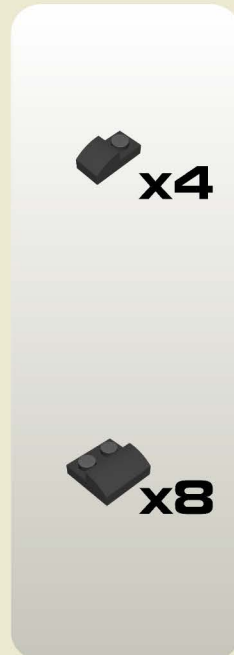
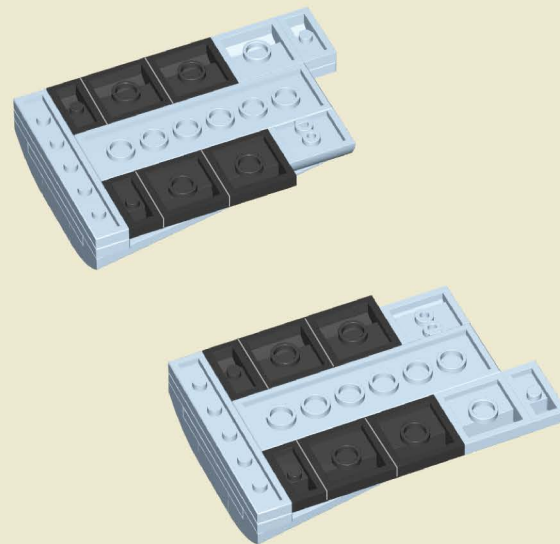



50

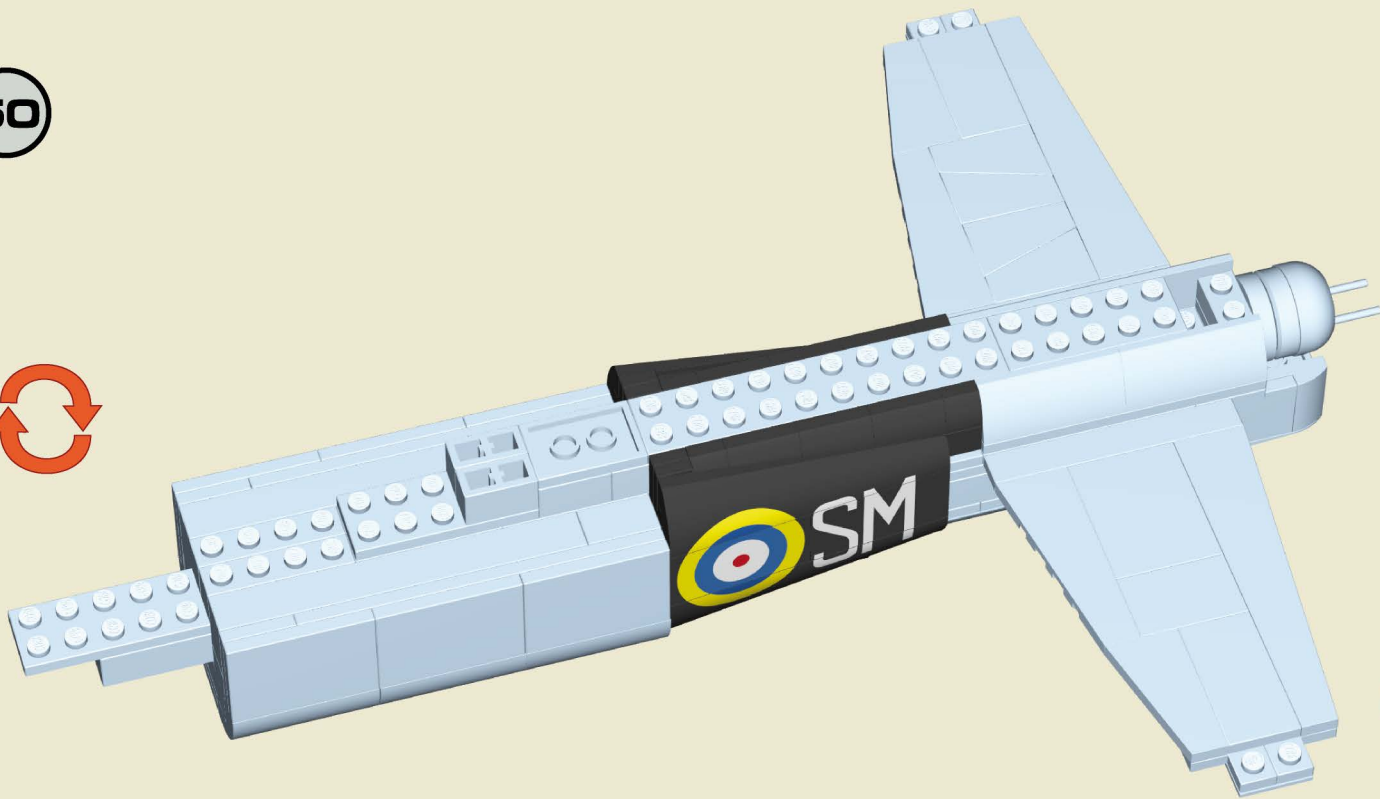

51

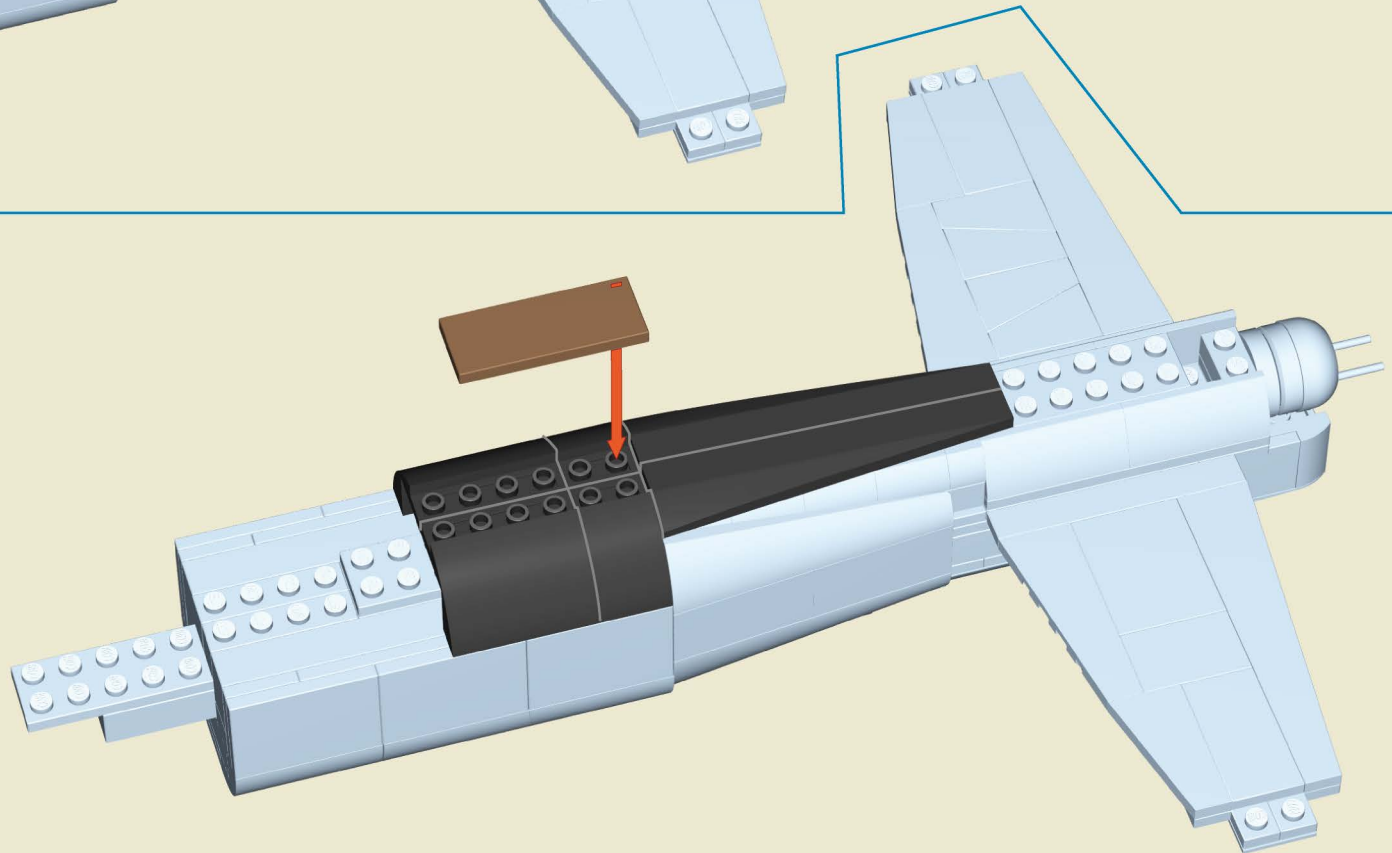
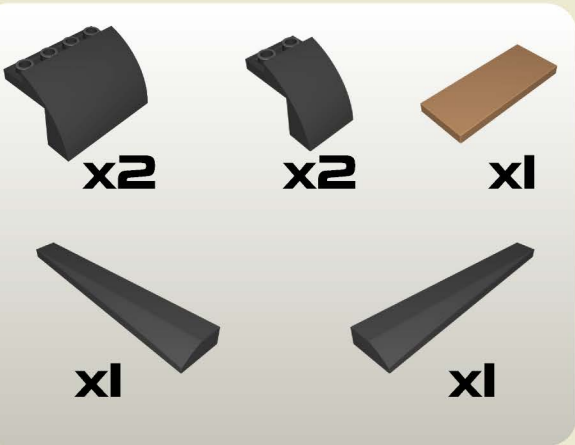

52

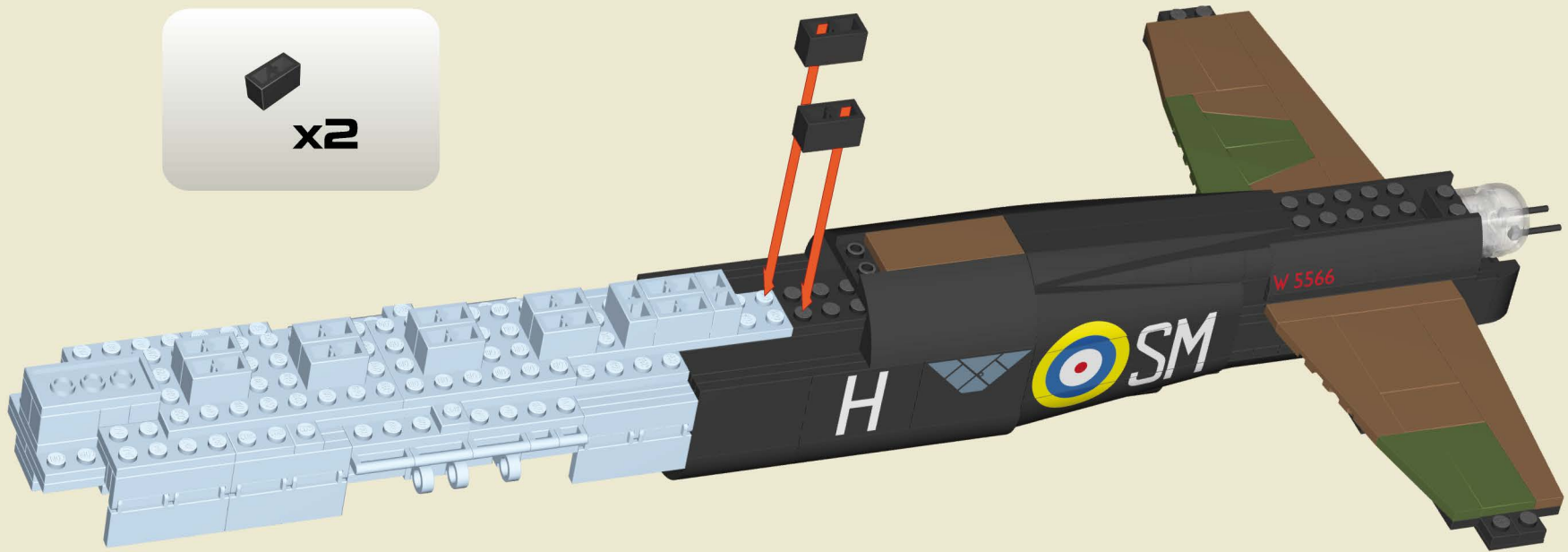

53

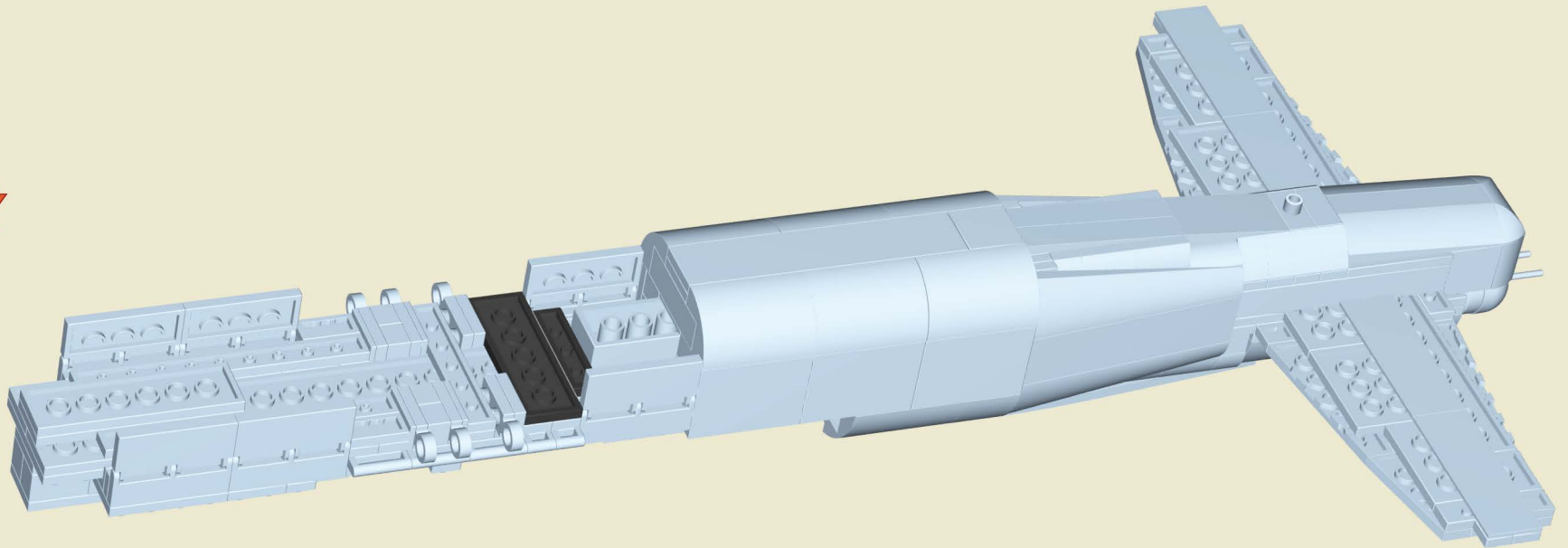
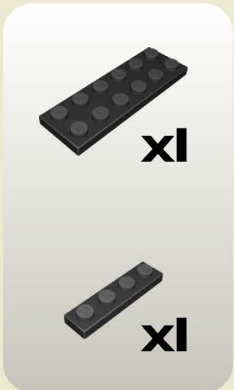

54

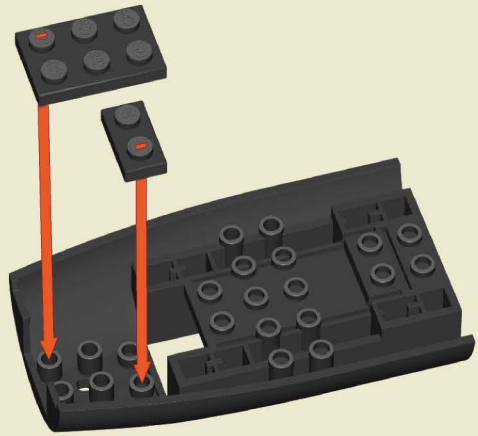

x1



x1

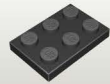

x1

55

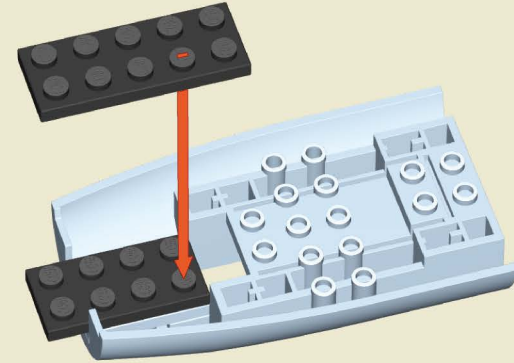

x1



x1

56

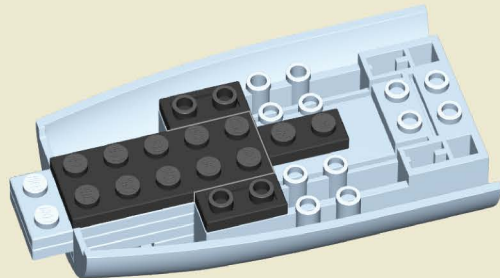

x1



x2



x1

57

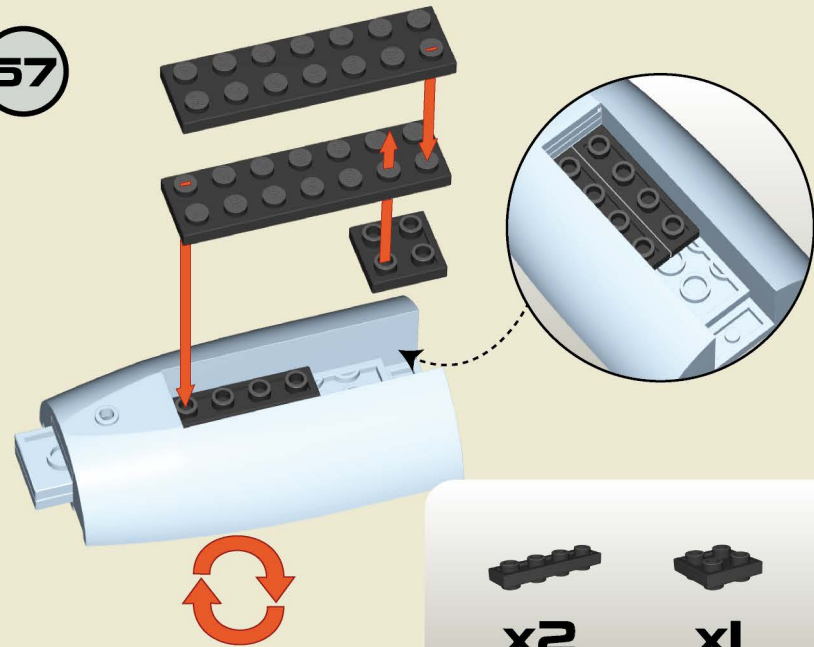

x2



x1



x2

58

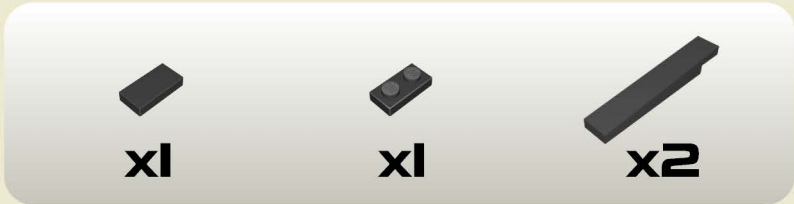
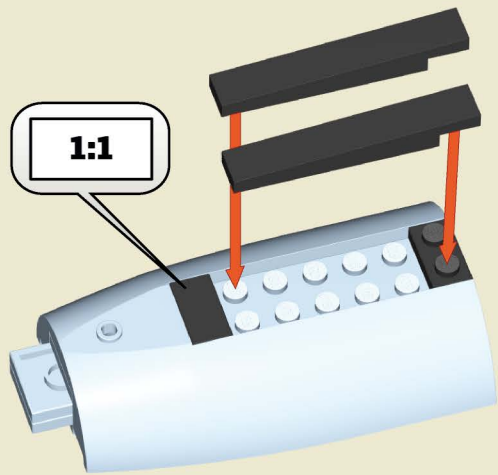

59

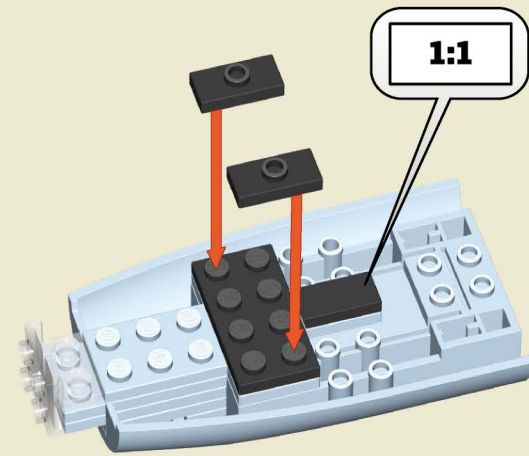

60

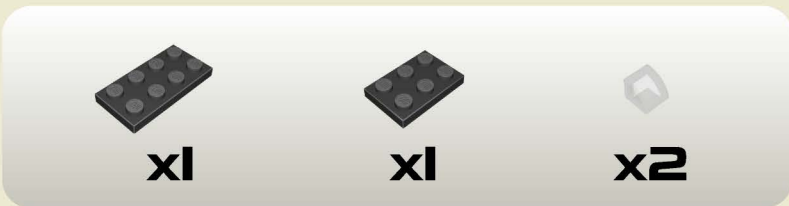
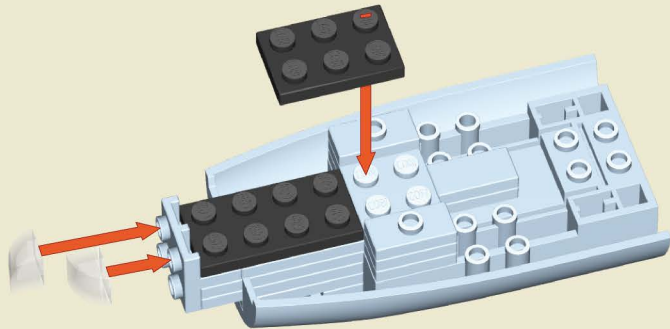

61

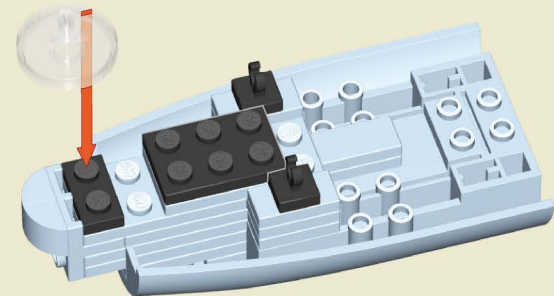



62



x2

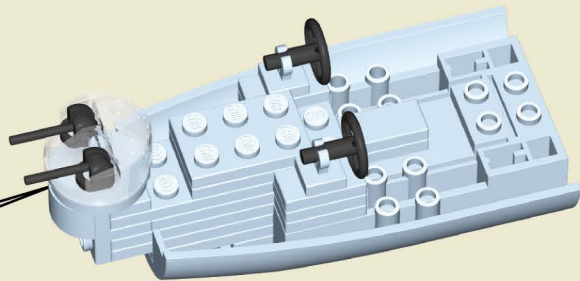

x2



x2



x1



x2

63

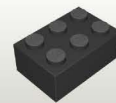
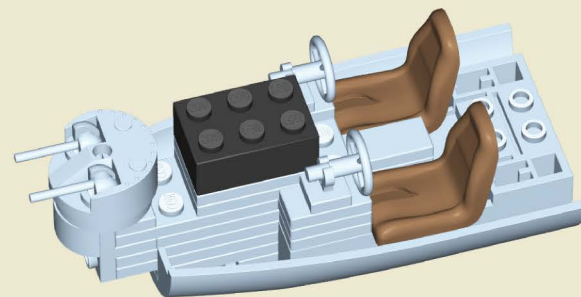

x1



x2

64

65 = 66



x1



x1

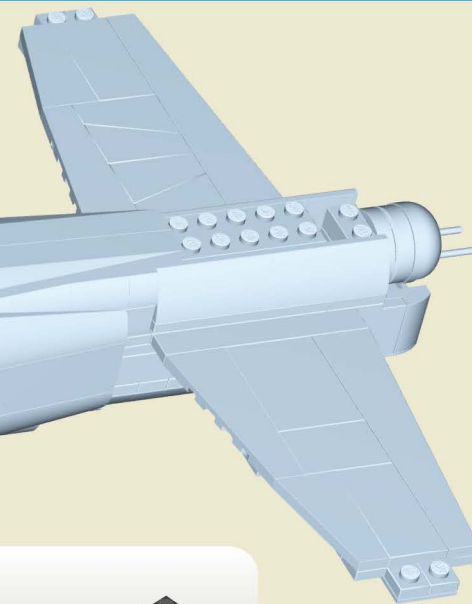

65

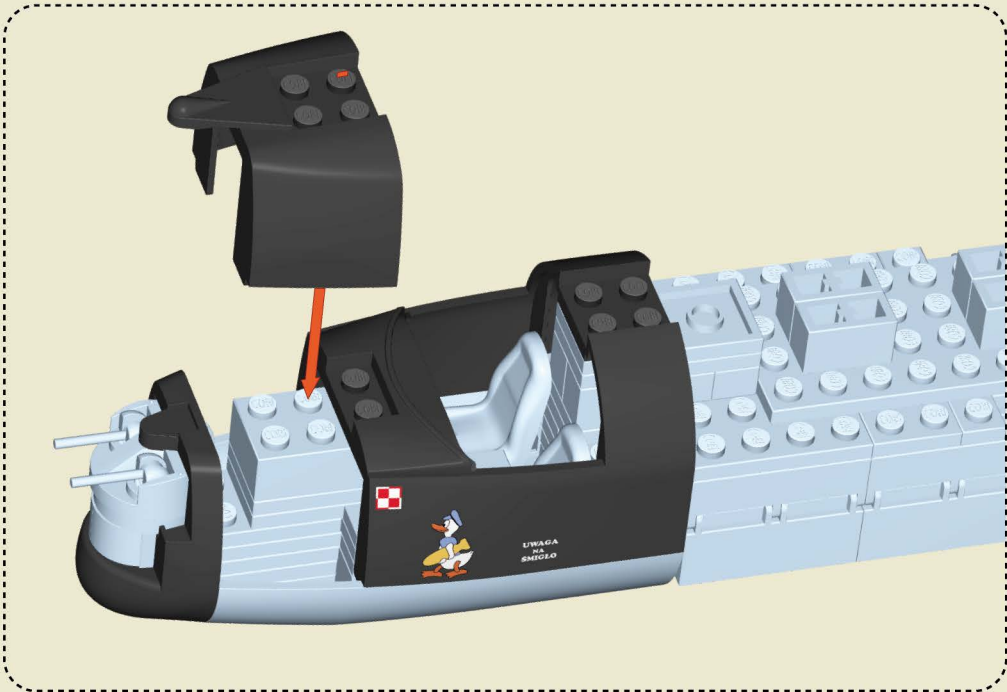

x1



x1



x1

66

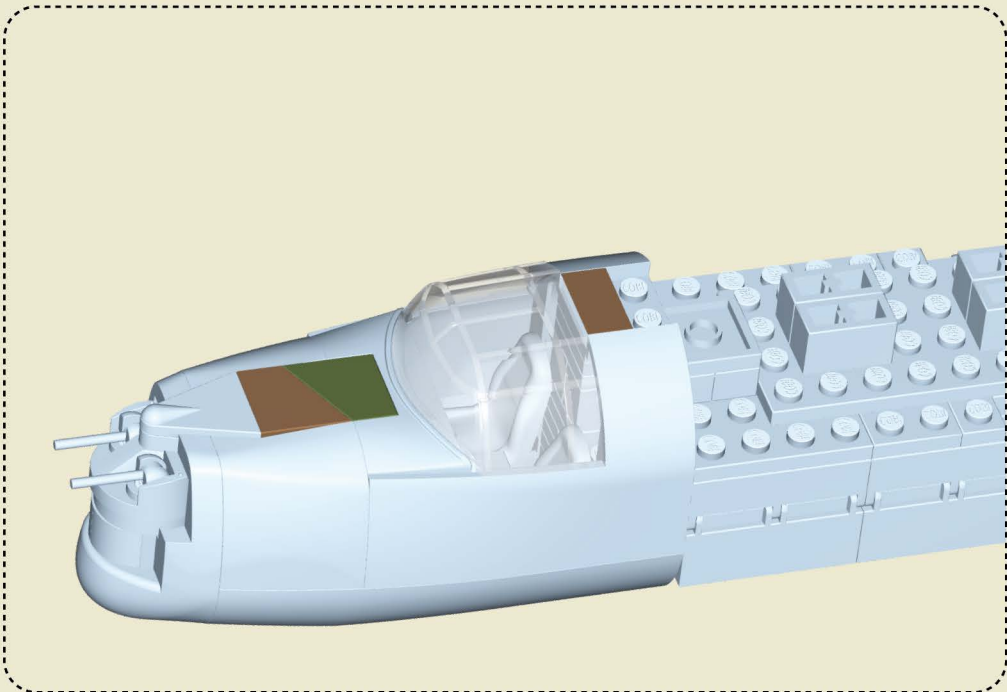

x1



x1

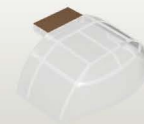

x1



67

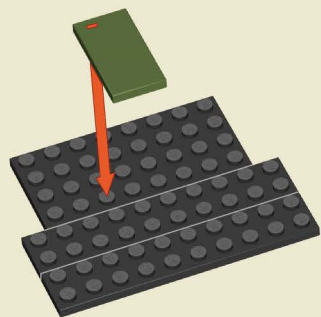

1:1

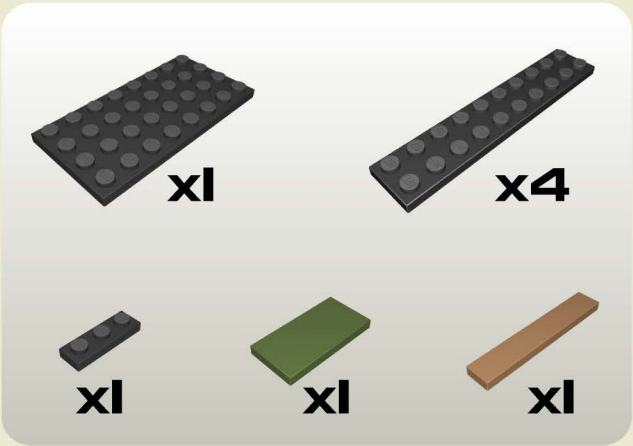
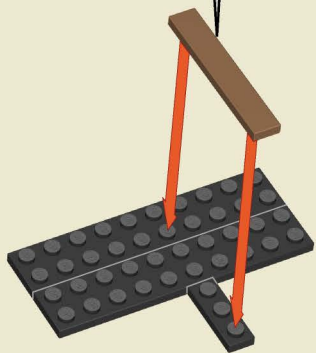

68

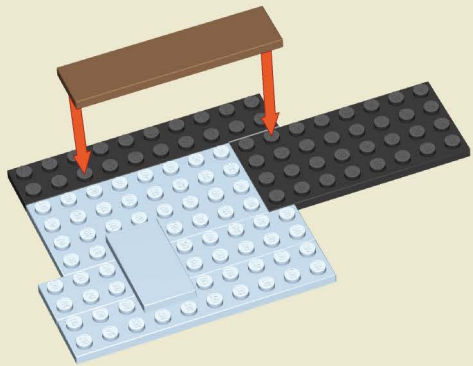

1:1

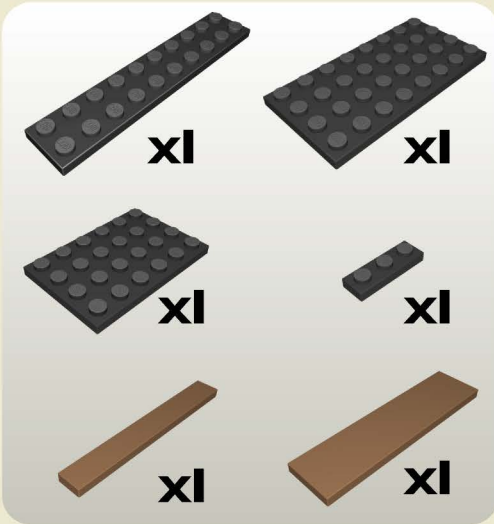
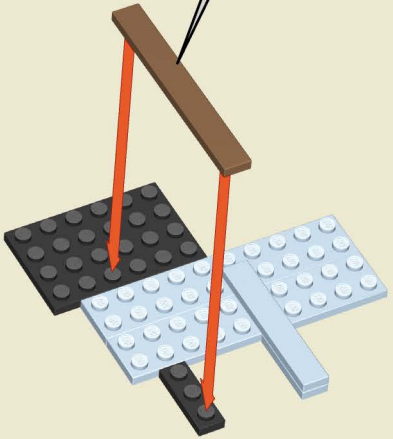

69

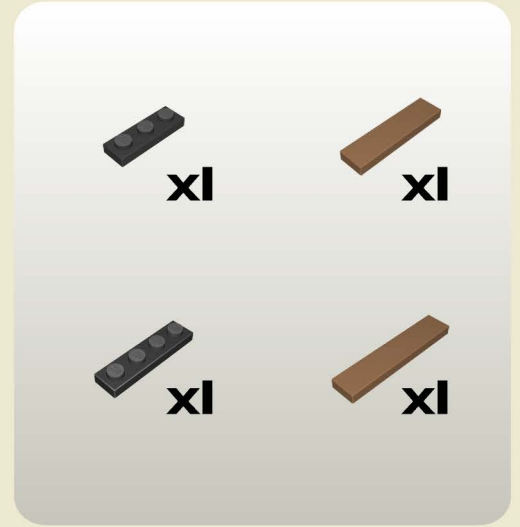
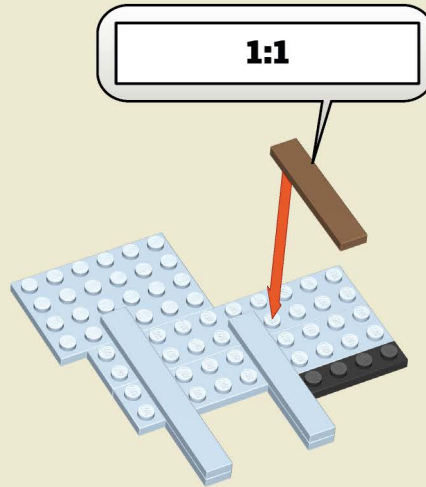
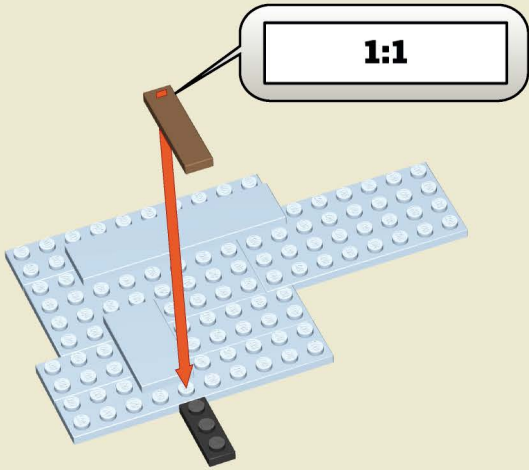

70

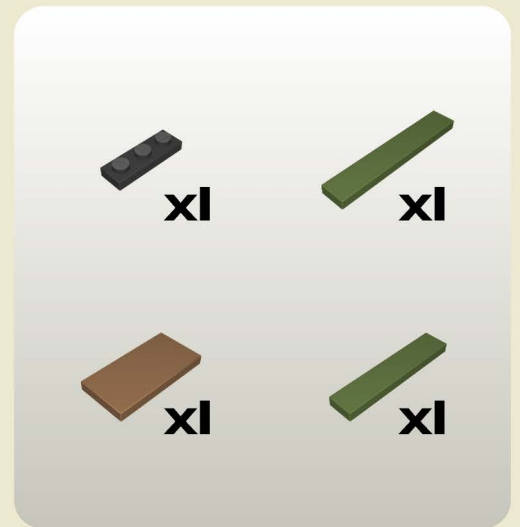
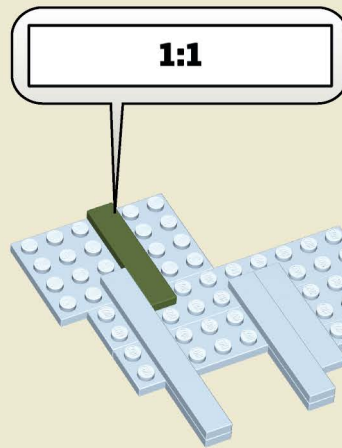
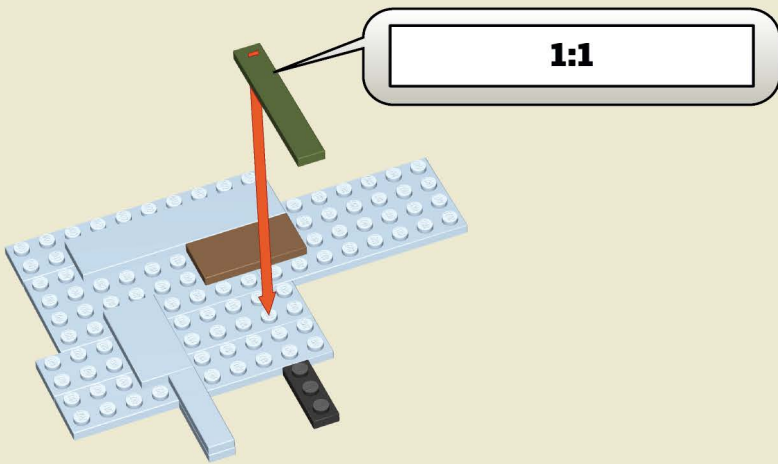



71

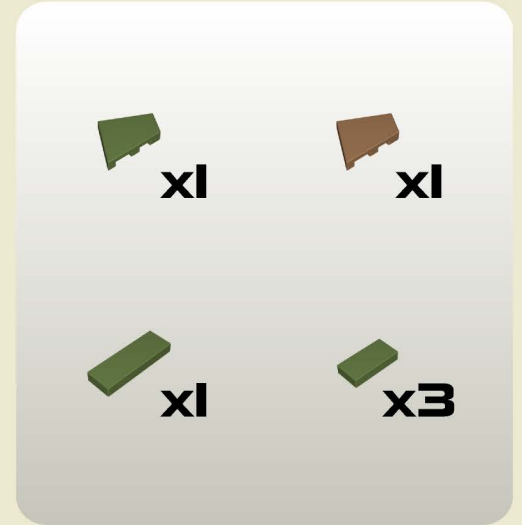
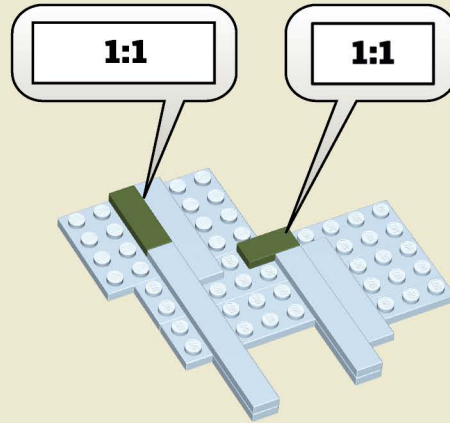
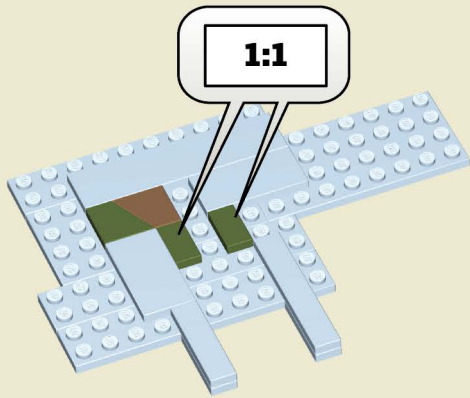

72

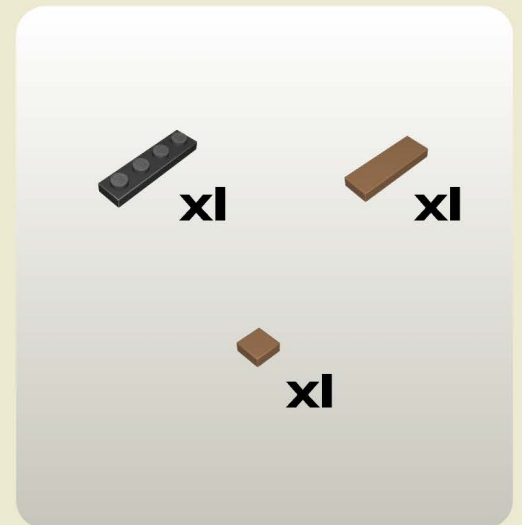
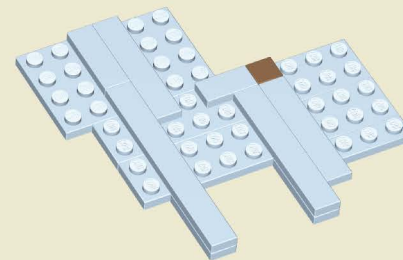
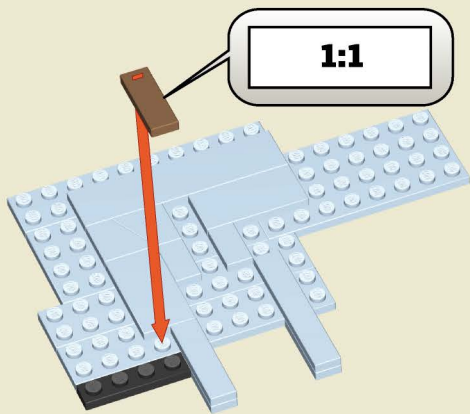

73

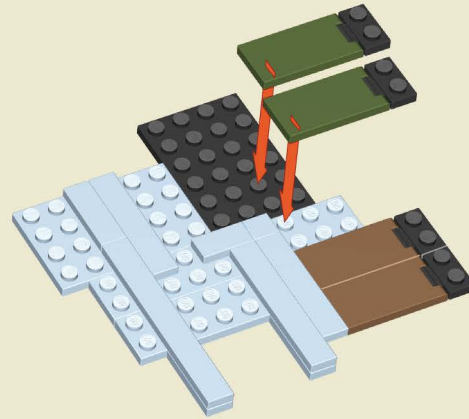
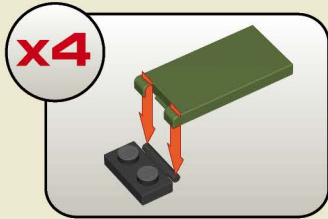
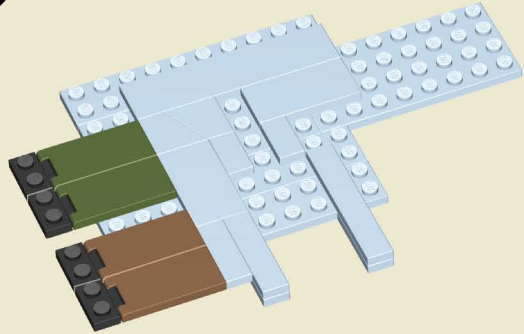

74

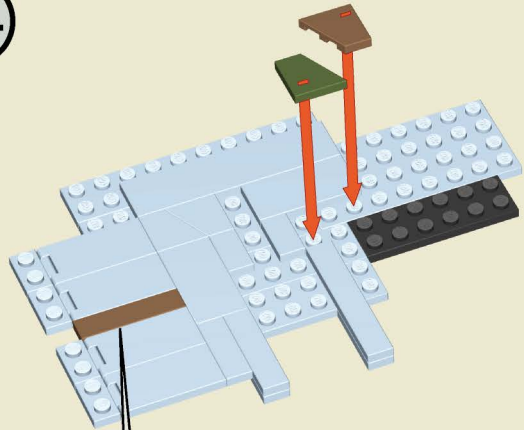

1:1

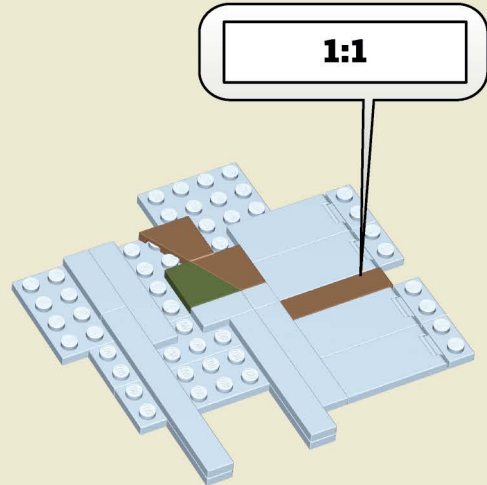

1:1



75

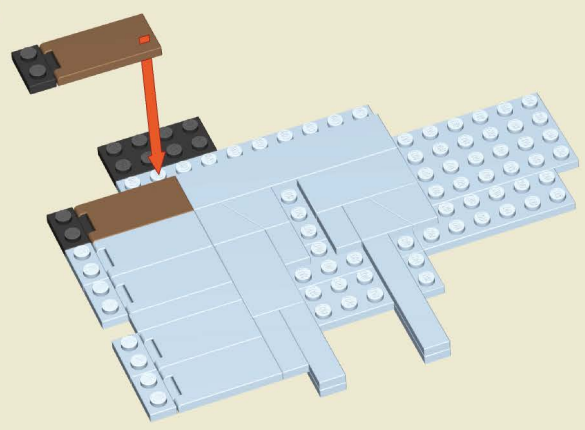

1:1

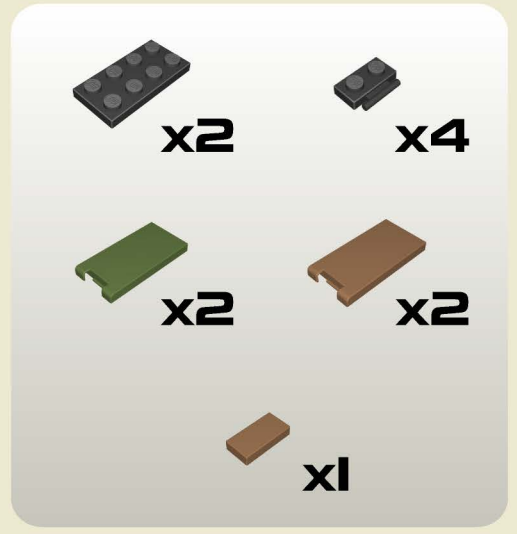
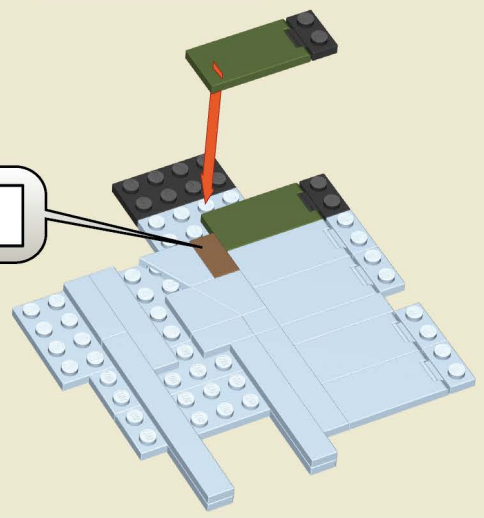

76

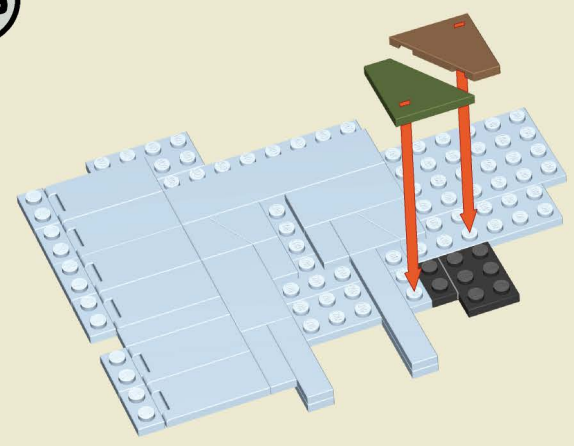

1:1

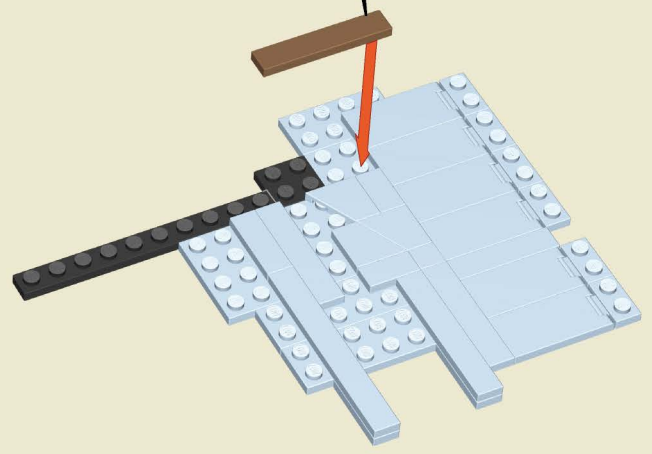

77

1:1

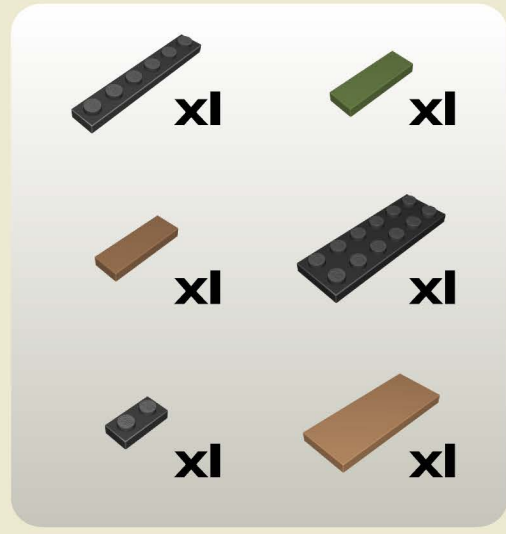
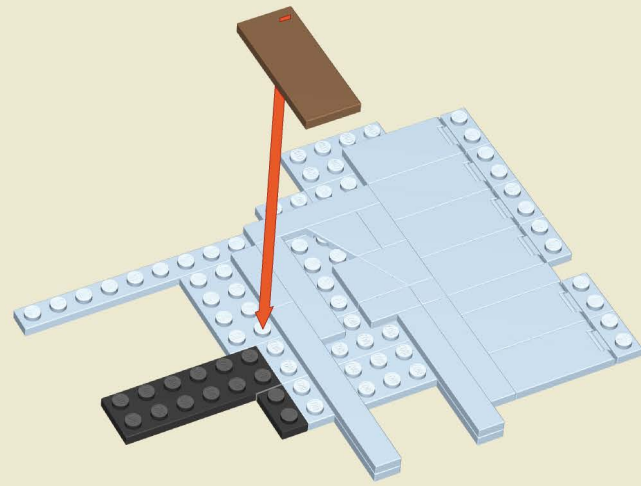
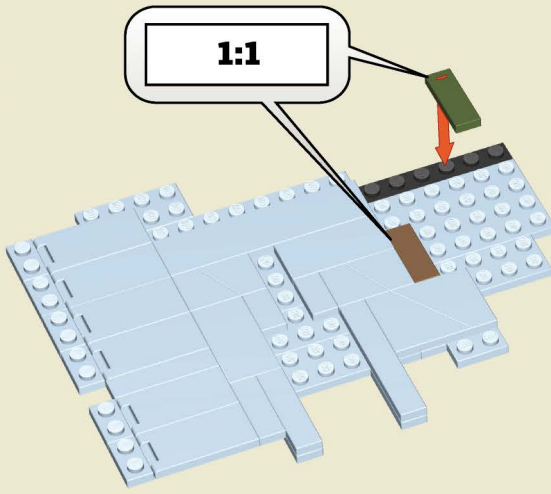

78

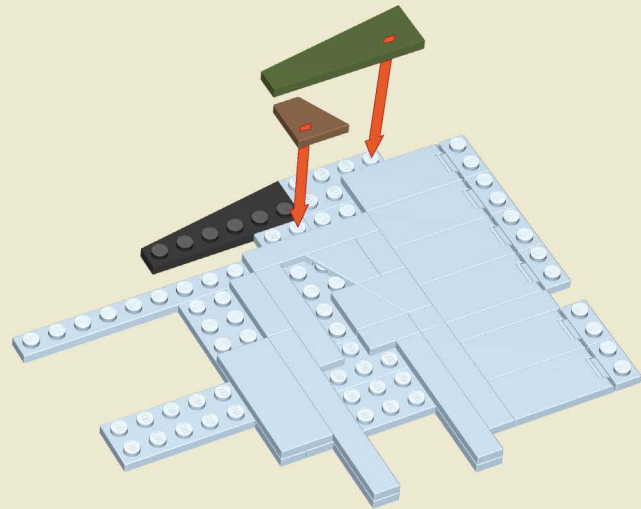
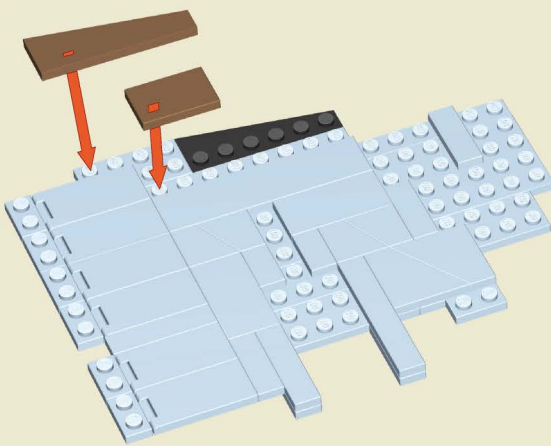



79

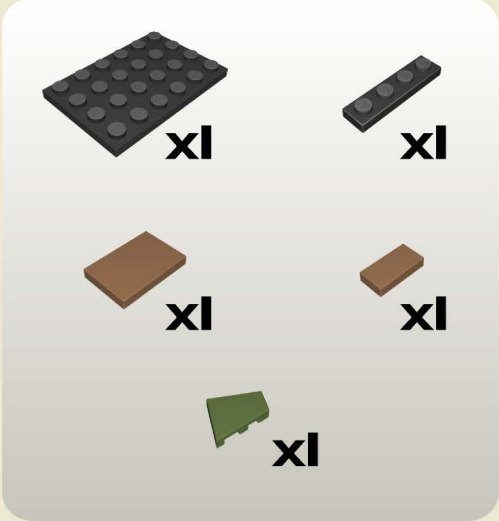
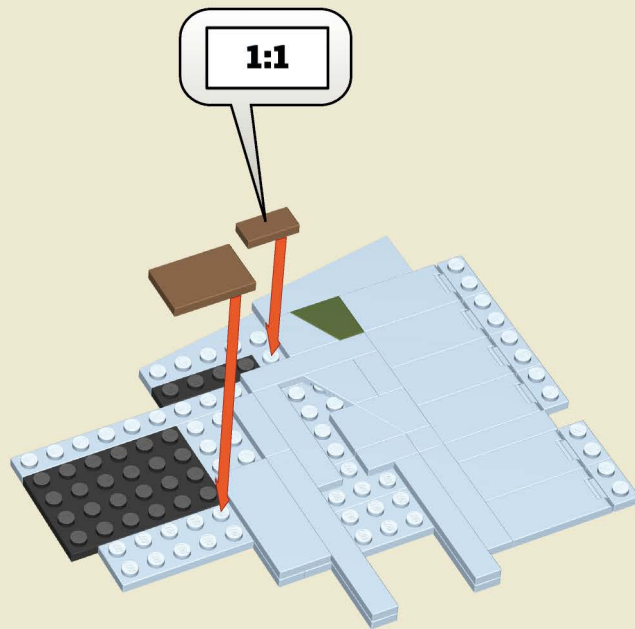
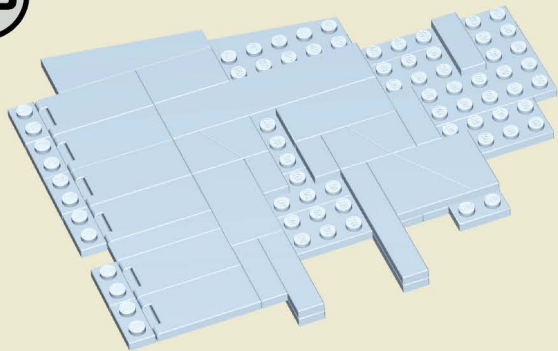

80

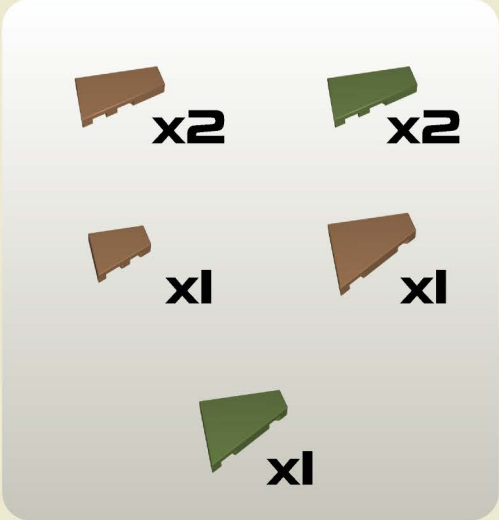
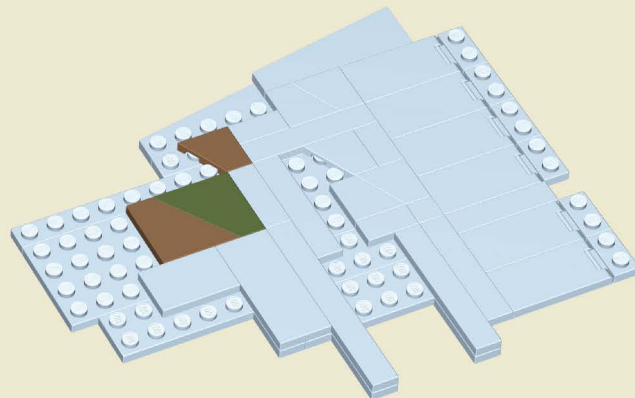
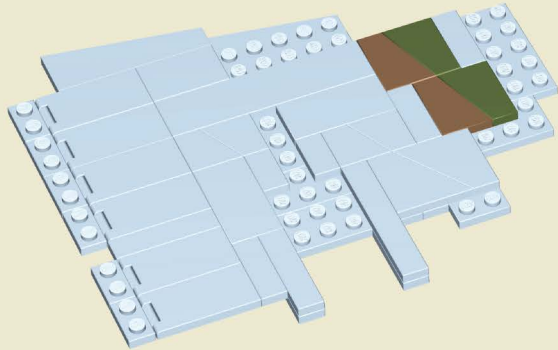

81

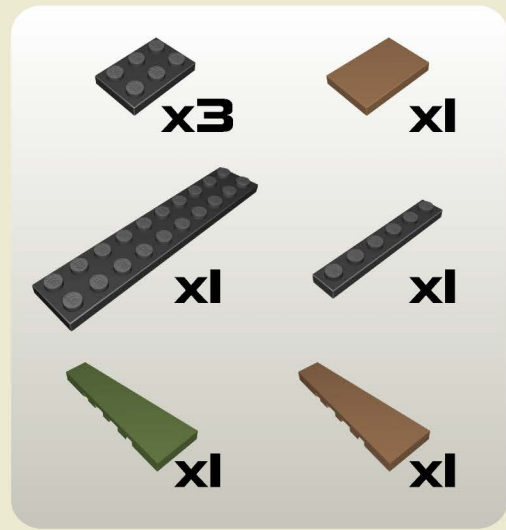
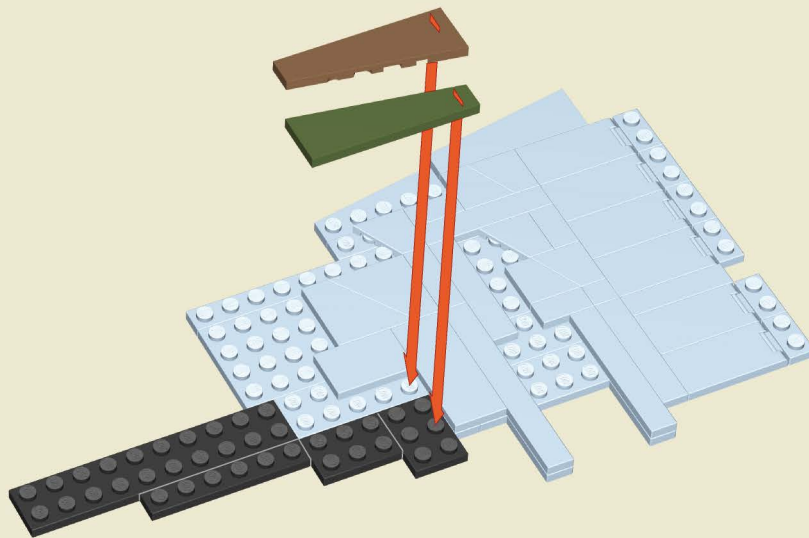
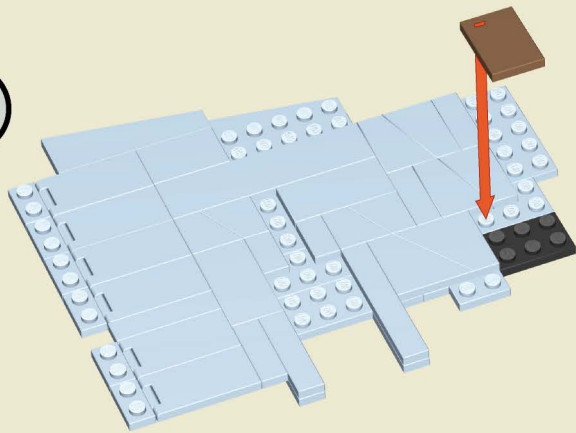

82

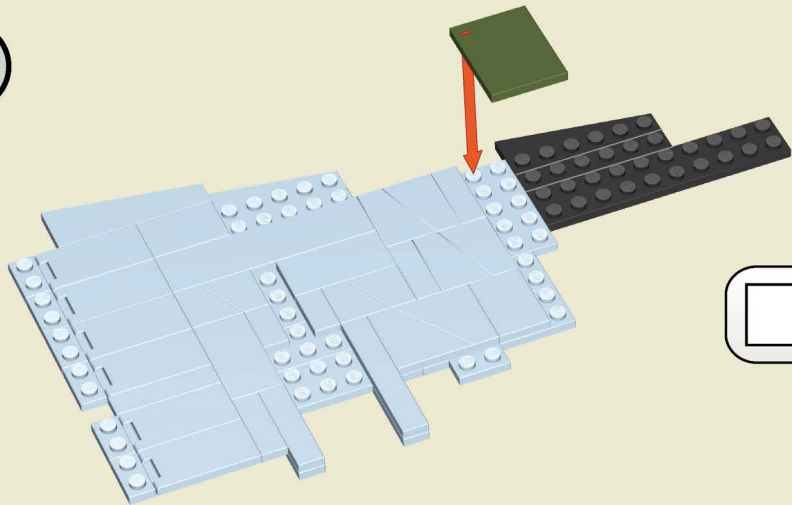

1:1

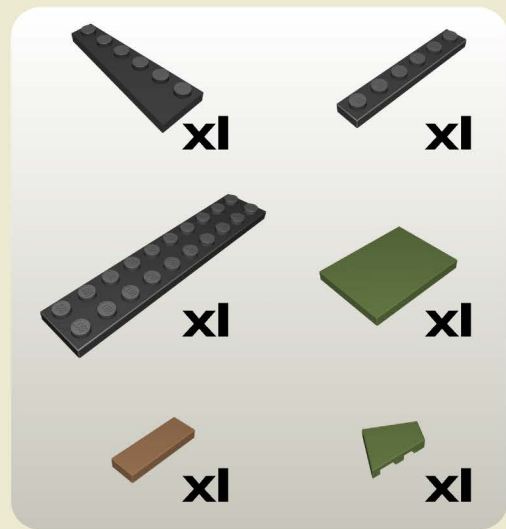
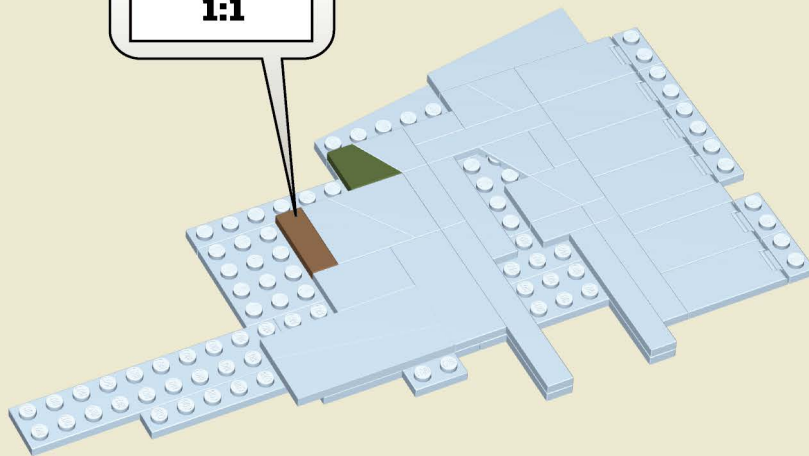

83

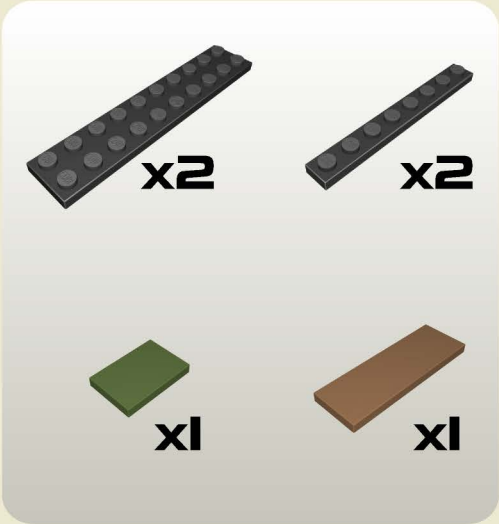
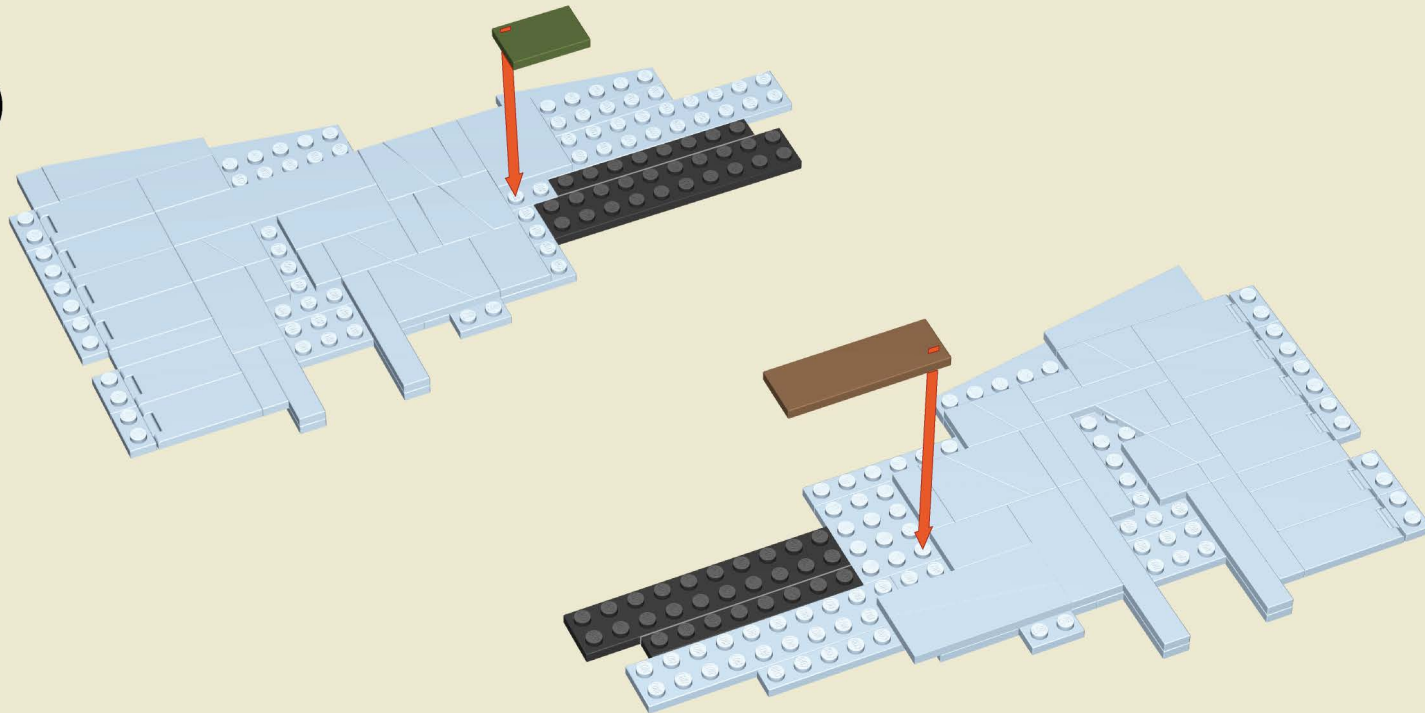



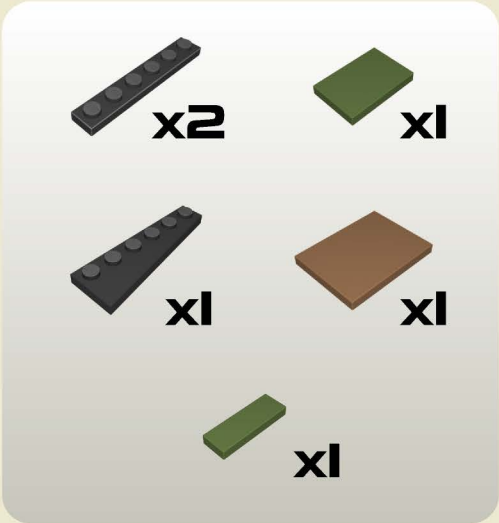
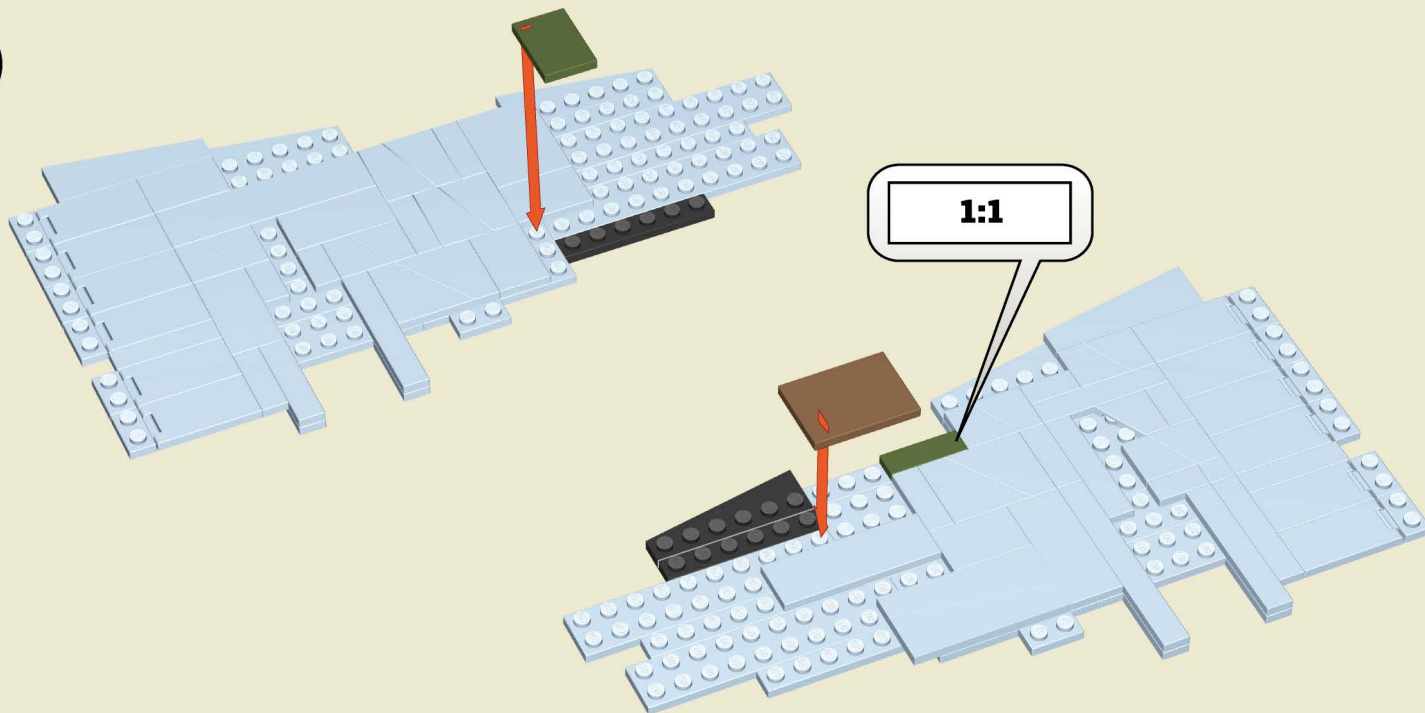

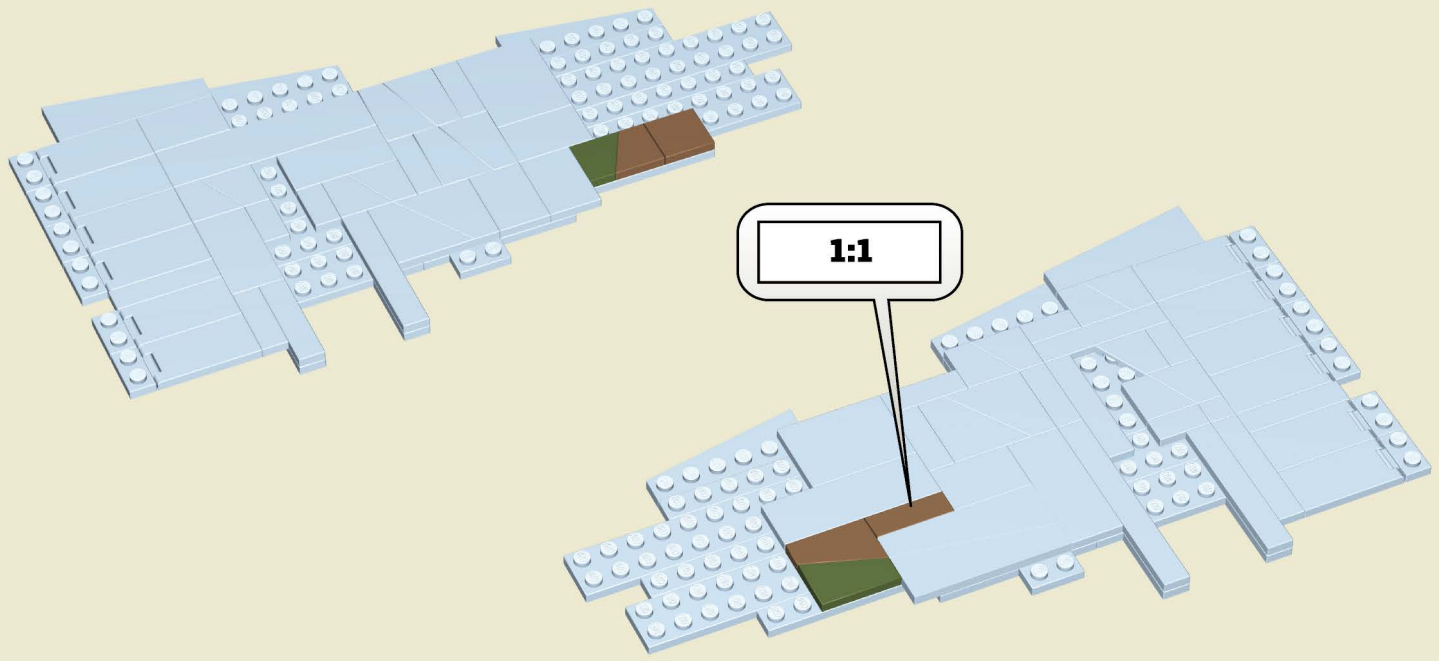

84







85

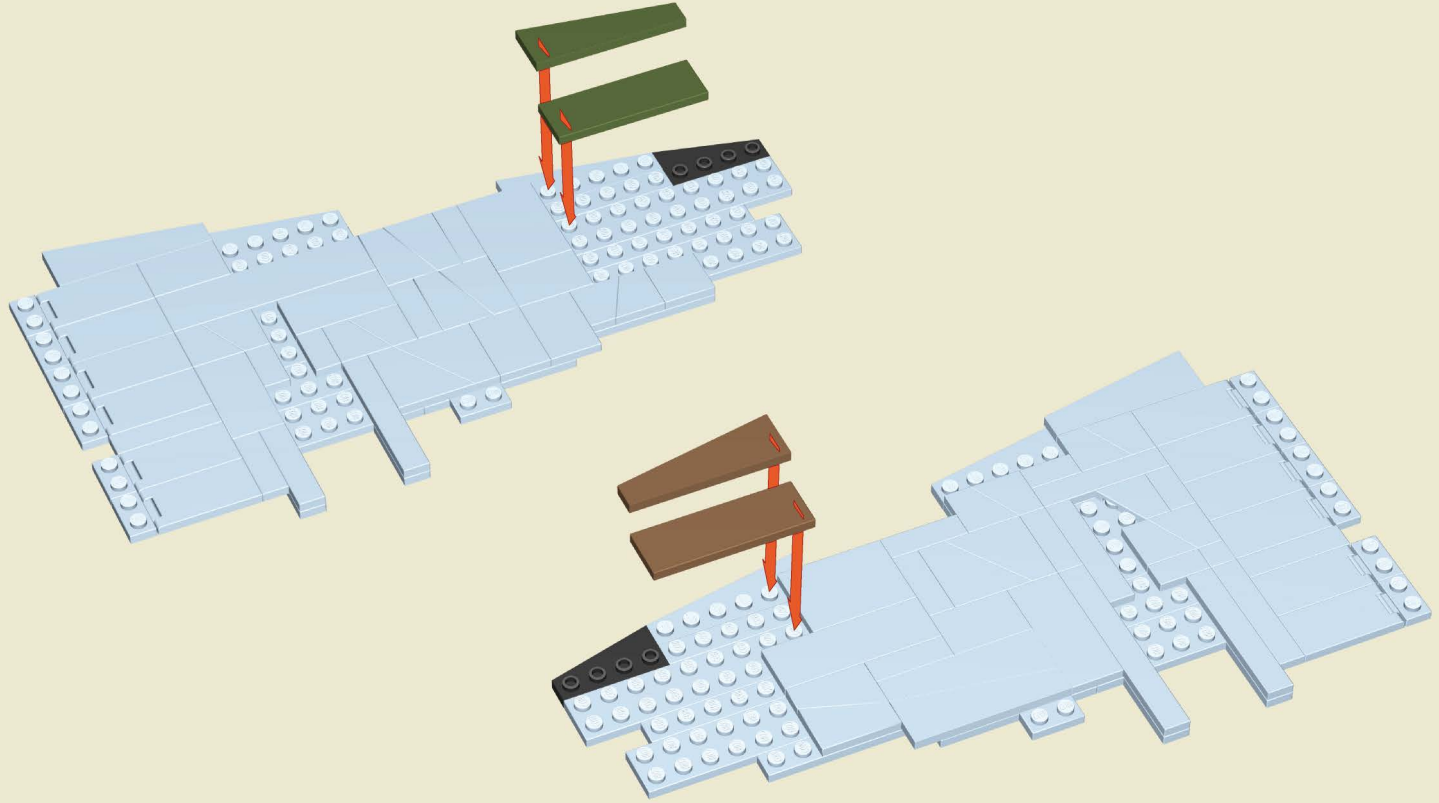

-   
 xi
-   
 xi
-   
 xi
-   
 xi
-   
 xi
-   
 xi

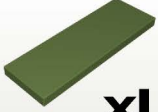
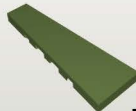
86



-   
 xi
-   
 xi
-   
 xi
-   
 xi
-   
 xi
-   
 xi





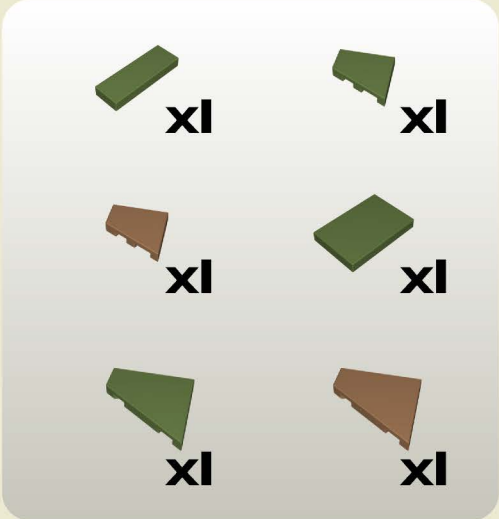
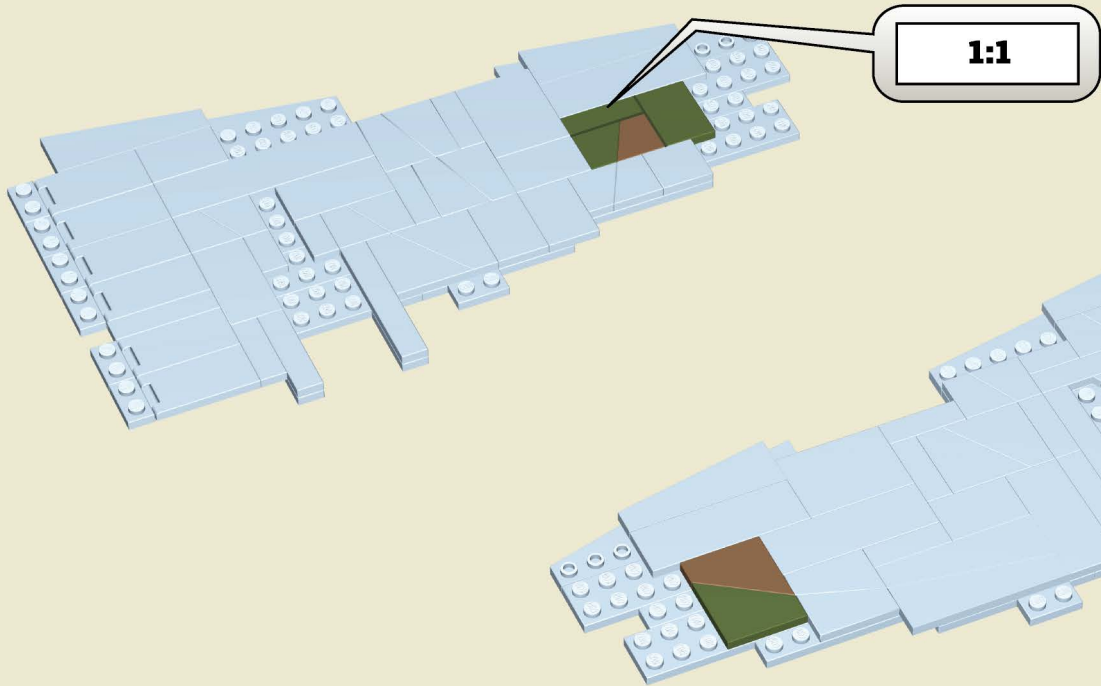

87

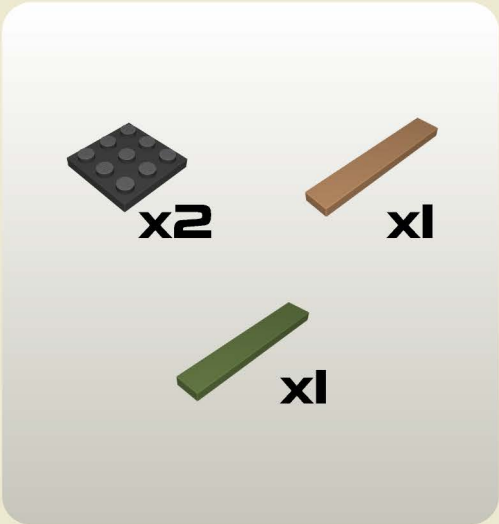
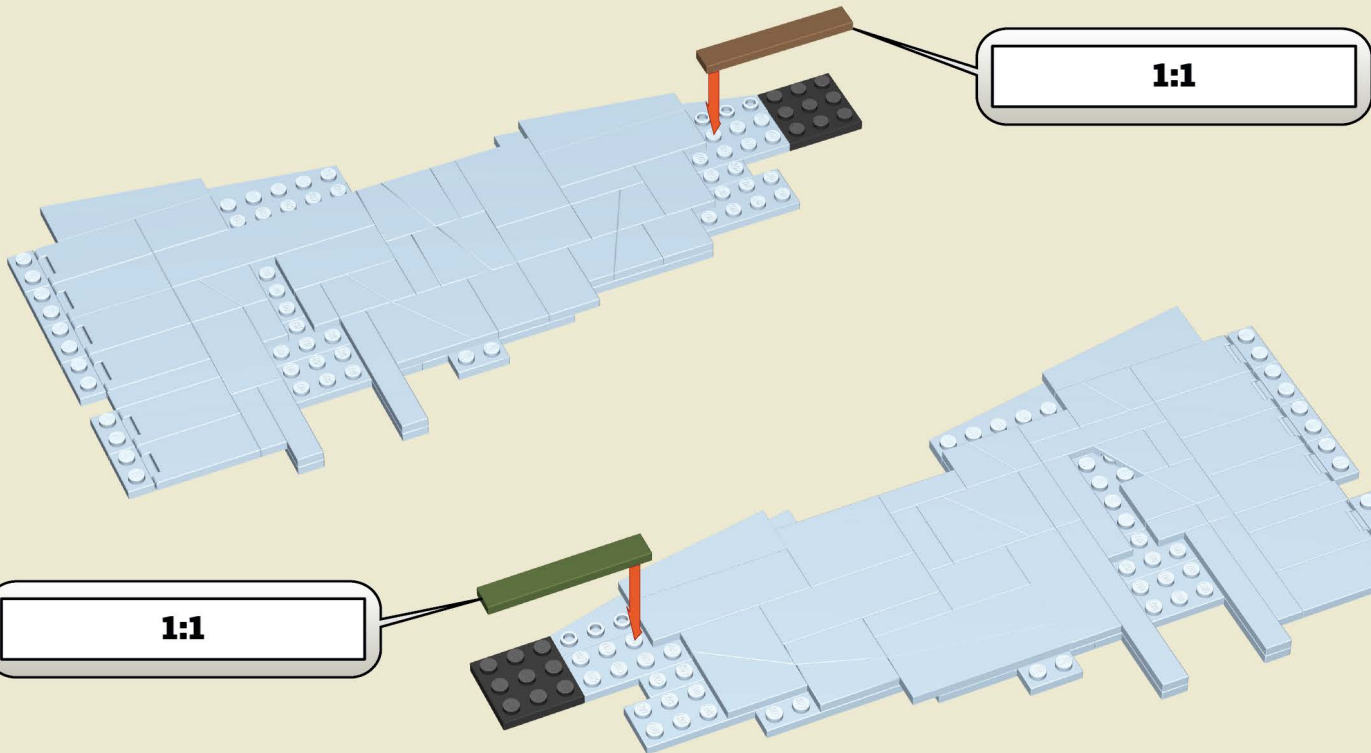

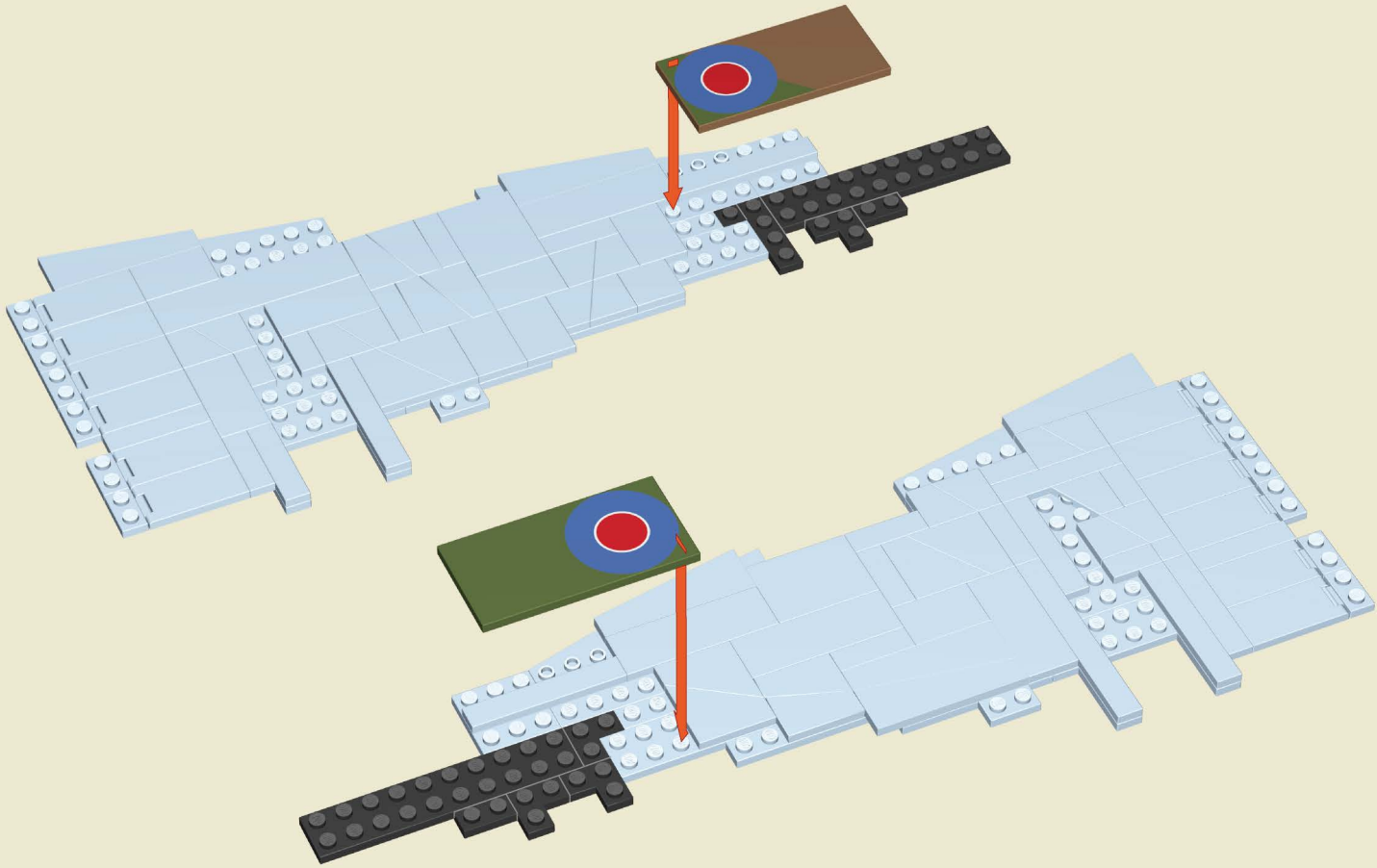
88





-  x1
-  x1
-  x2
-  x4
-  x2
-  x1
-  x1

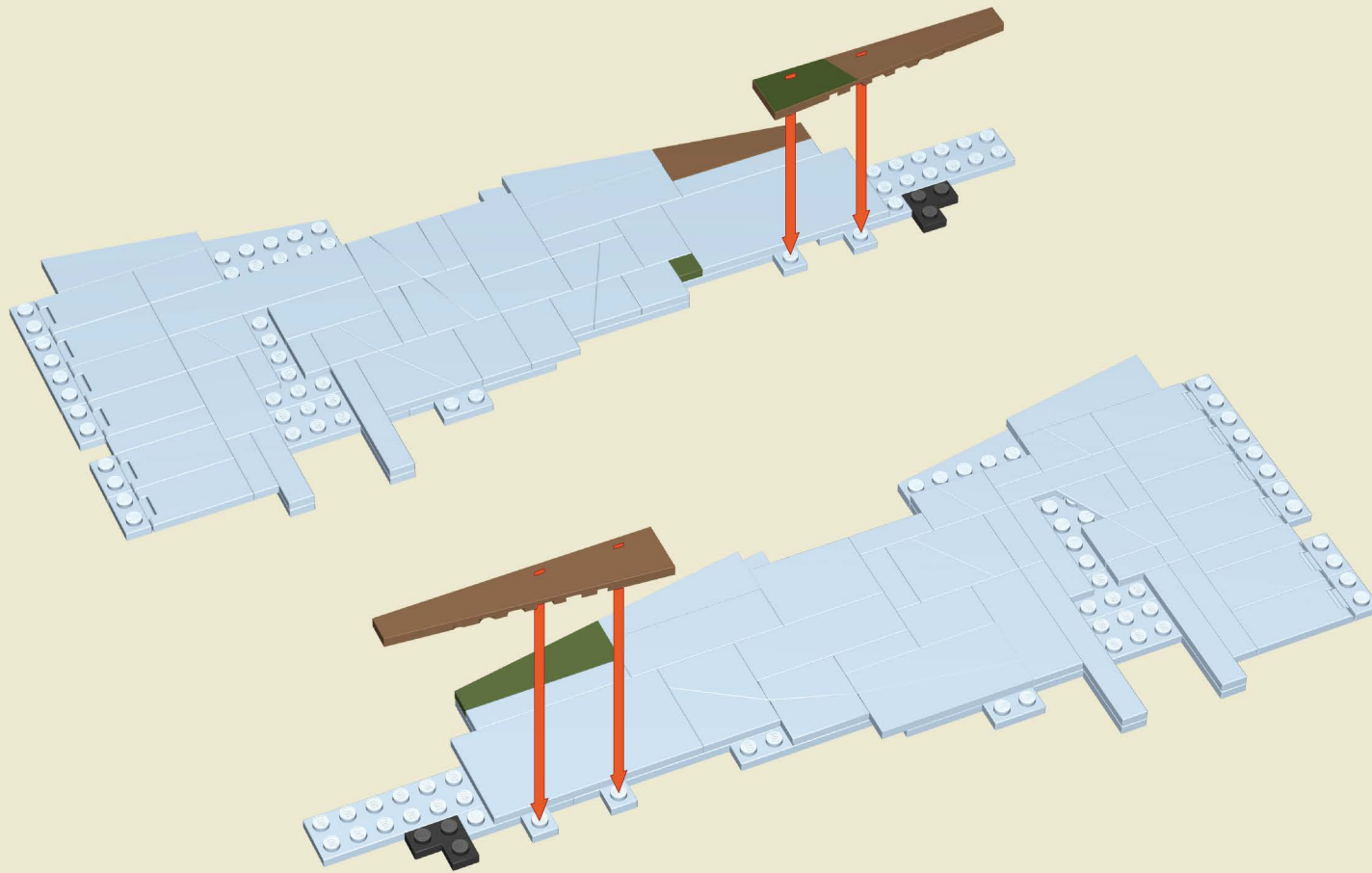

x2

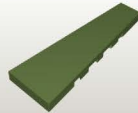

x1



x1



x1



x1

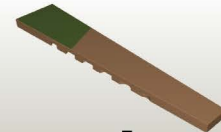

x1

91

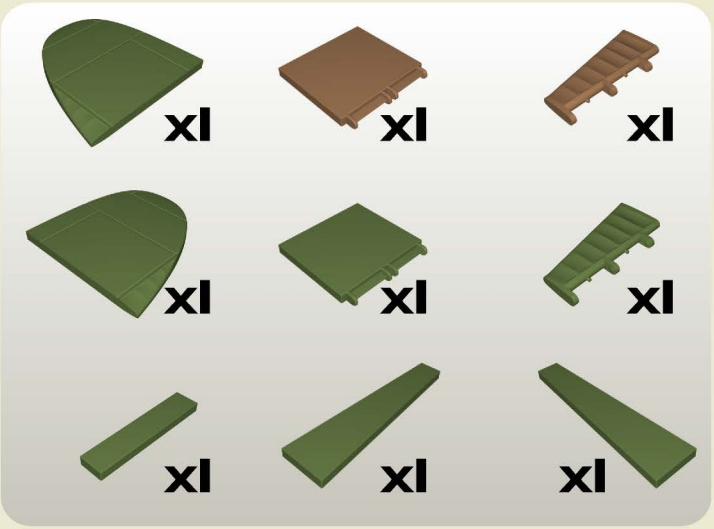
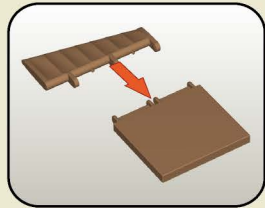
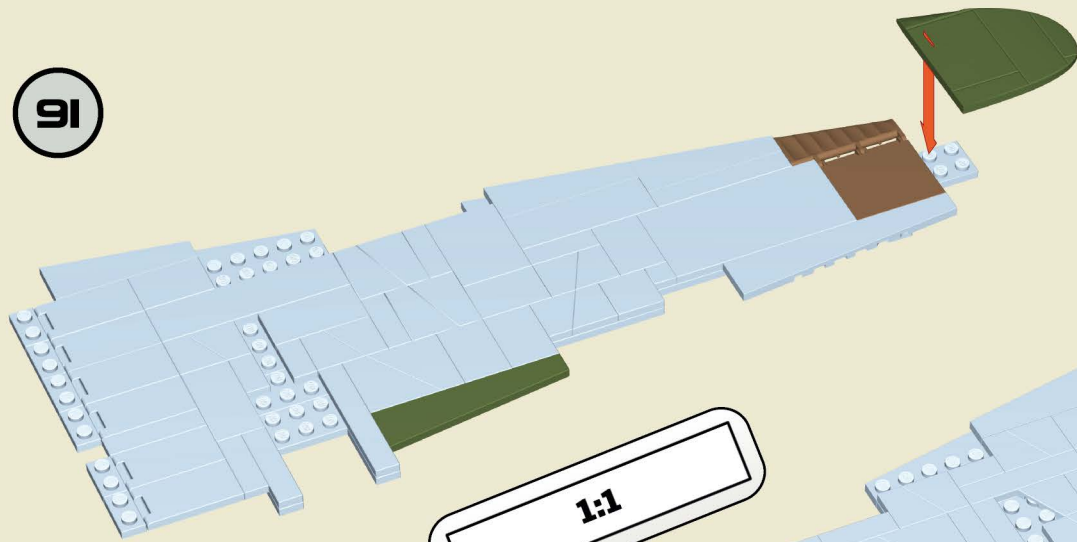

1:1

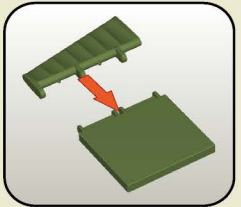
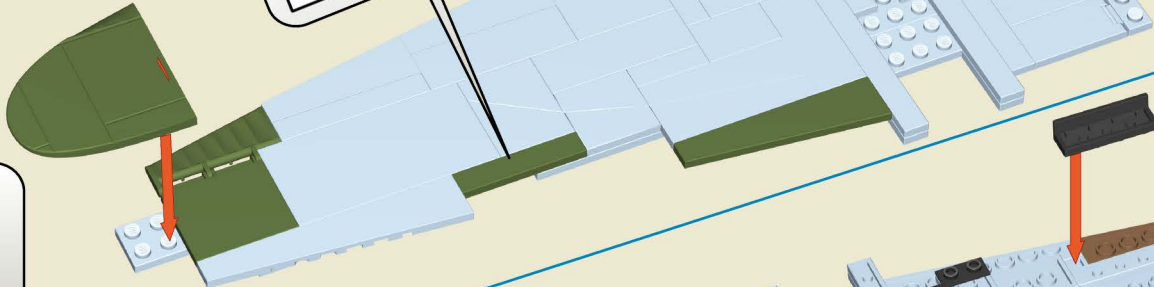

92

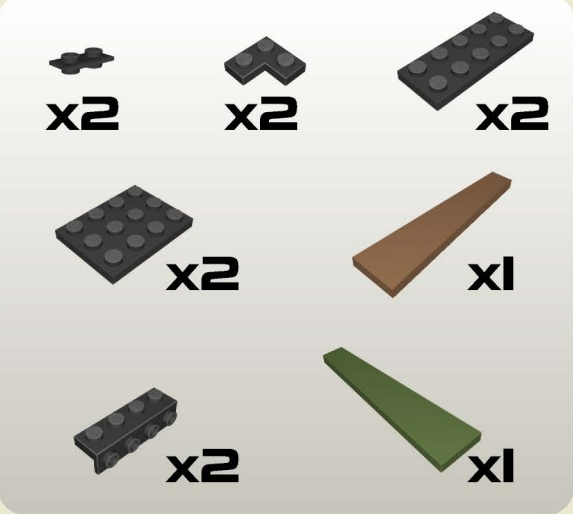
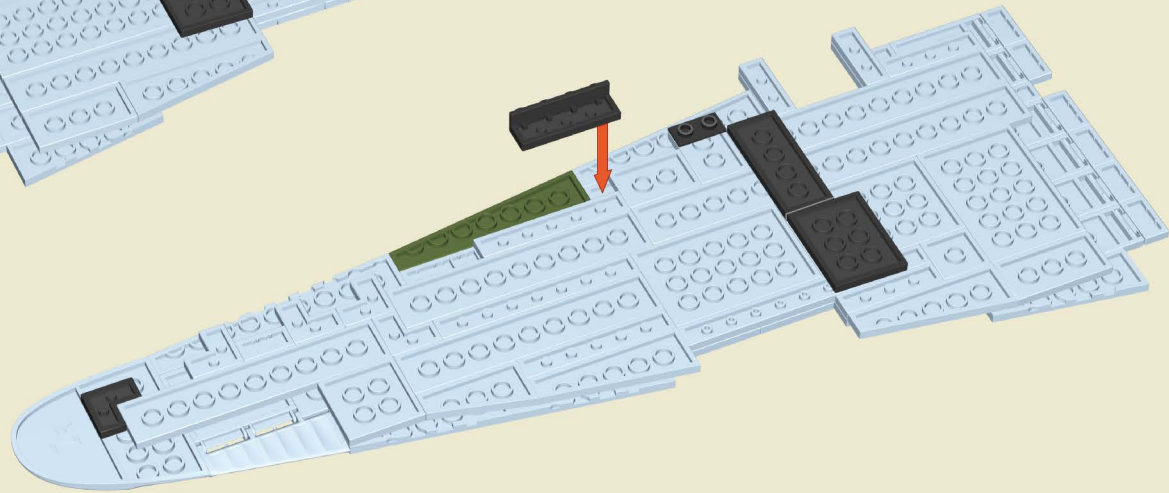
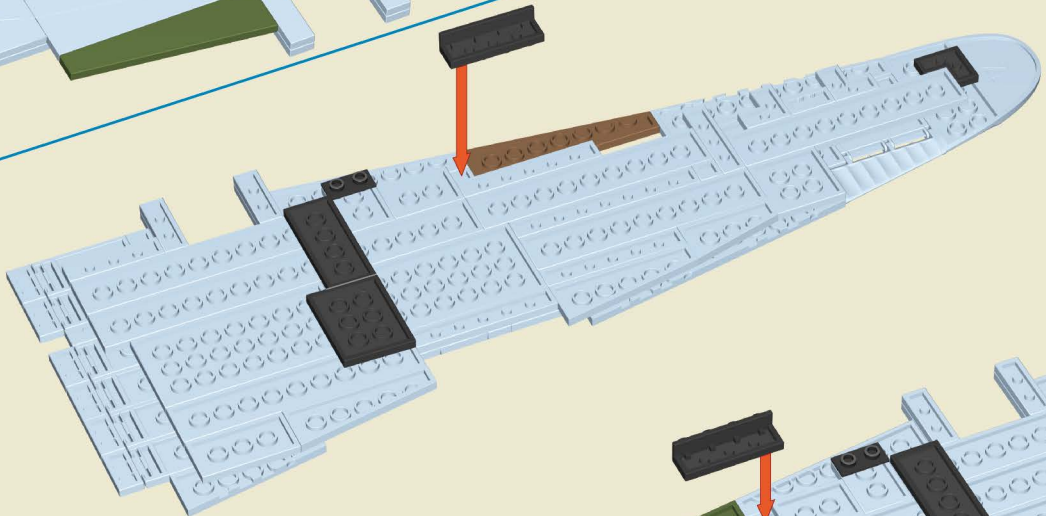



93

1:1

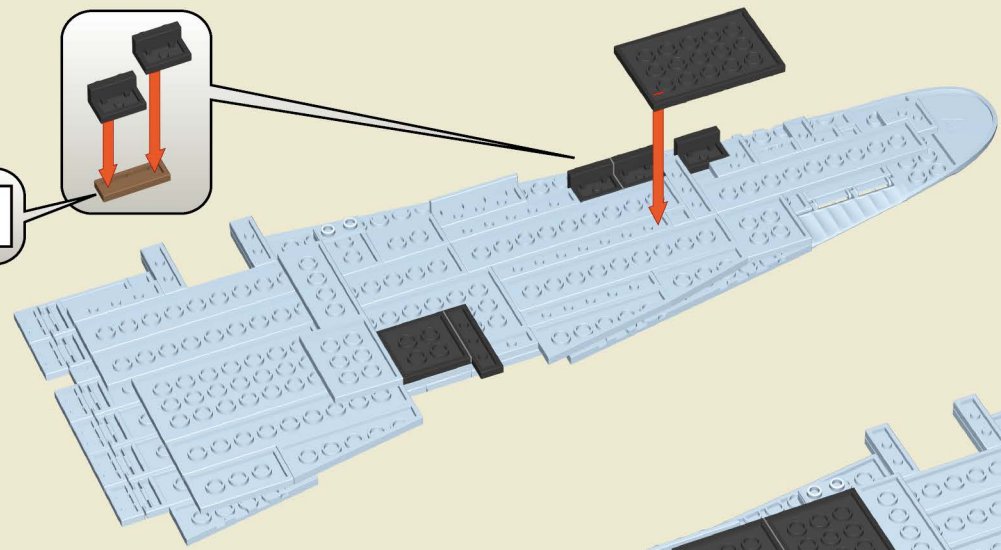
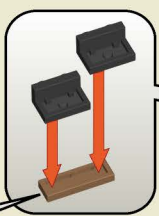

x3



x3



x2



x2



x1

94



x1



x2



x2



x2



x1



x1



x1

1:1

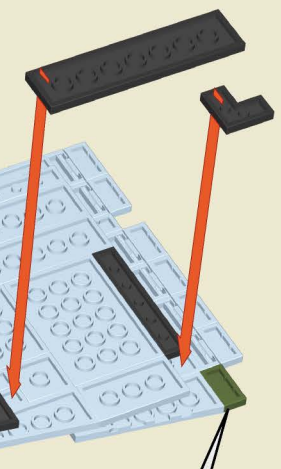
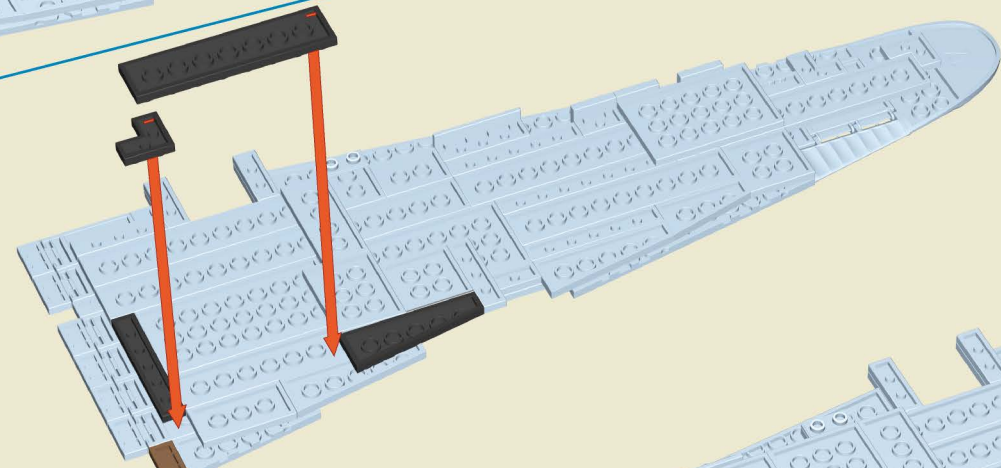

1:1

95

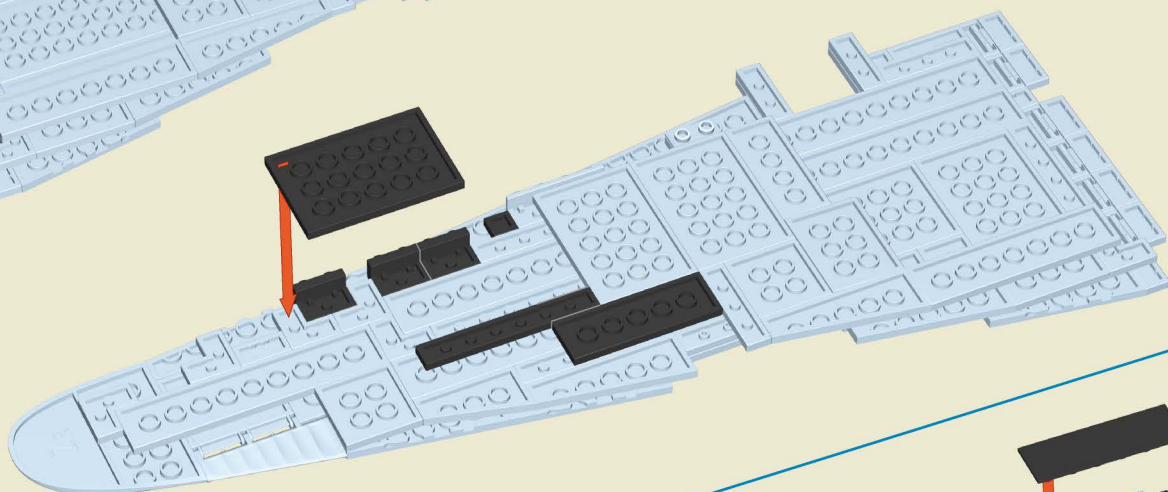
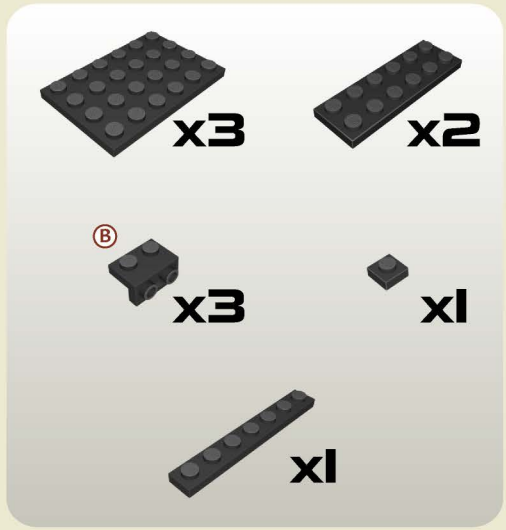
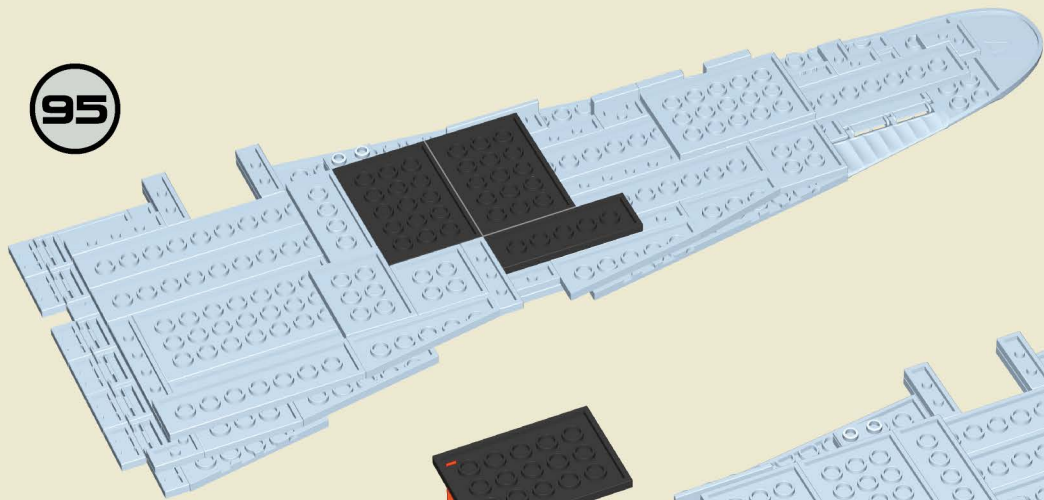

96

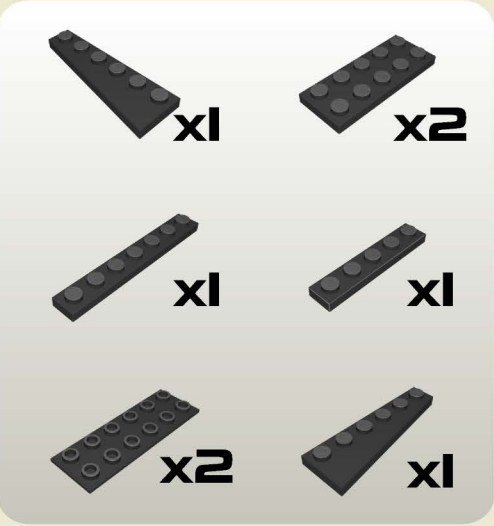
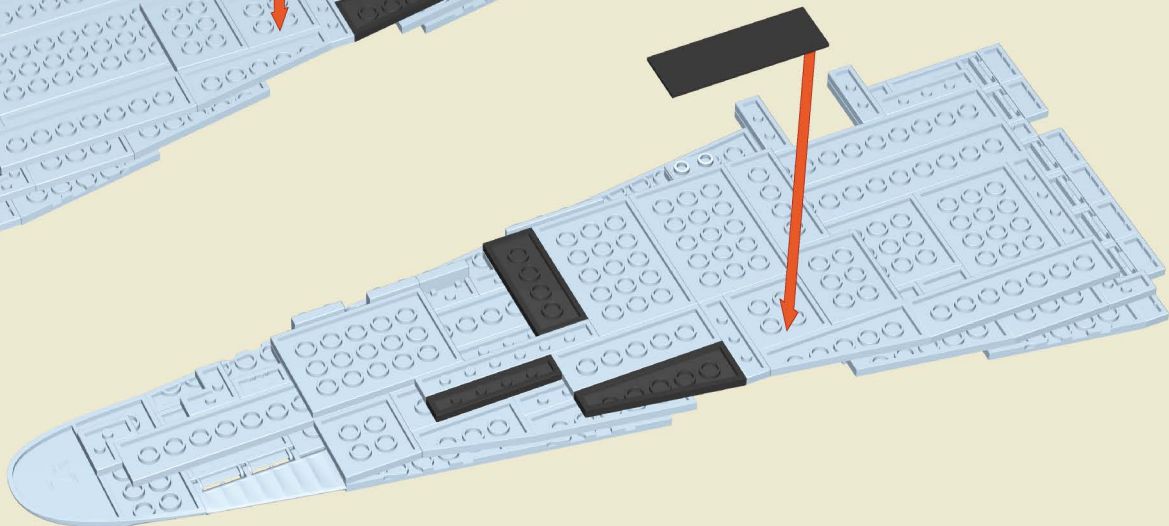
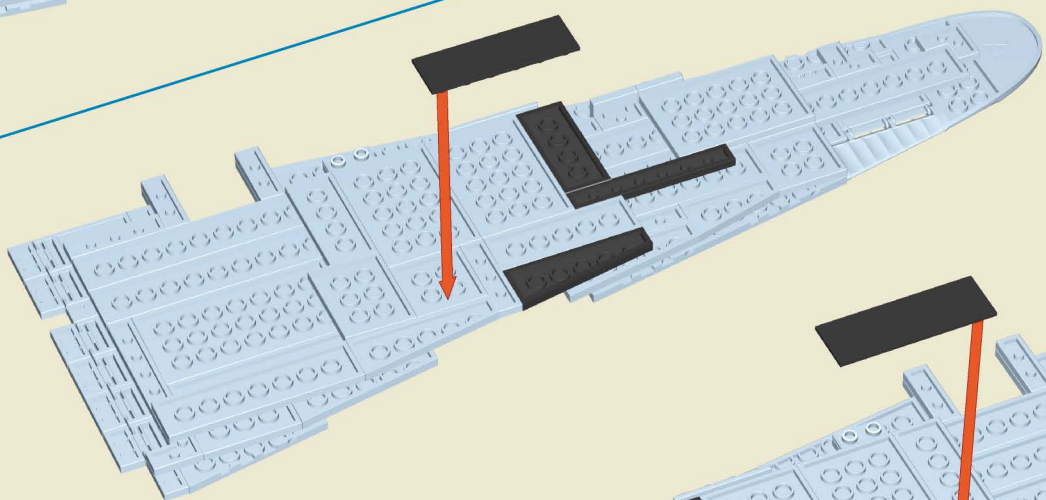



97

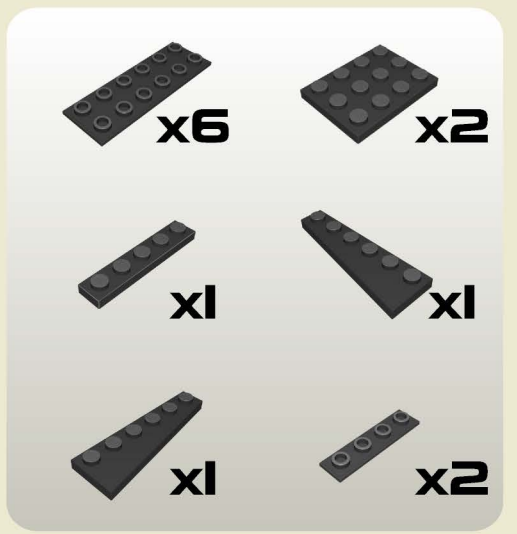
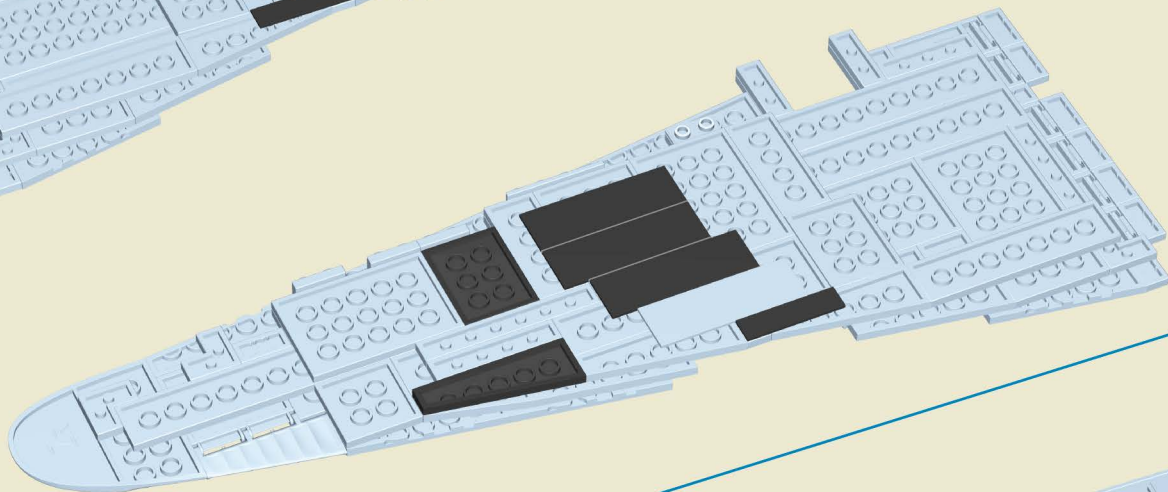
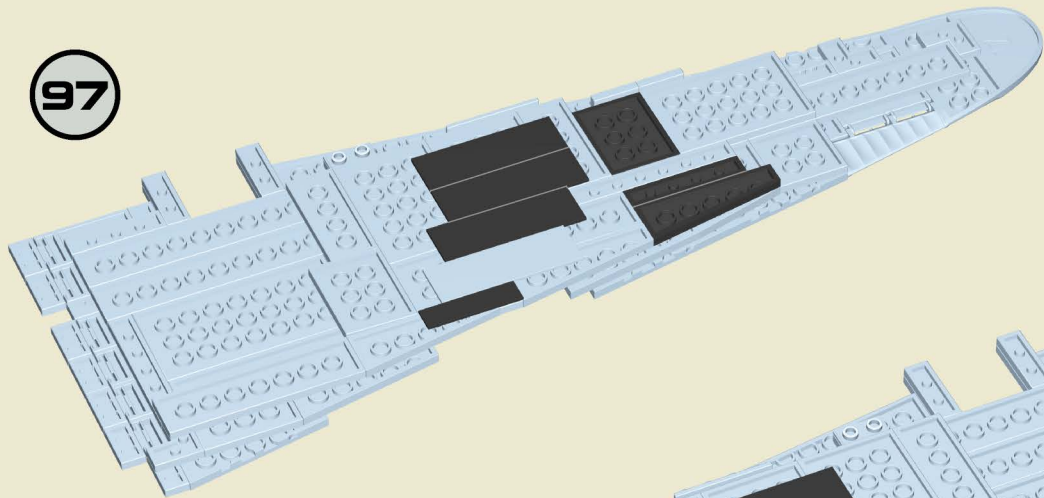

98

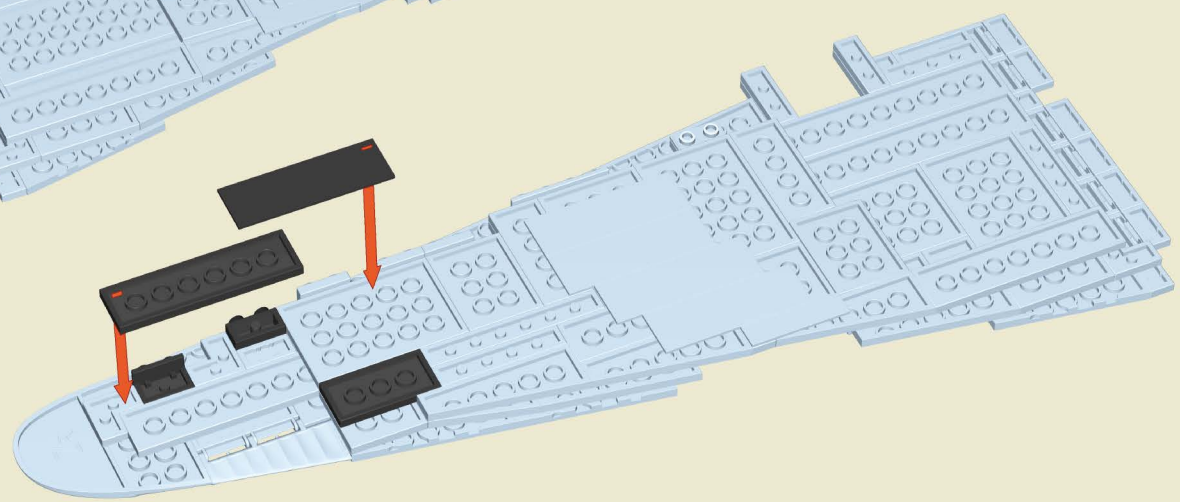
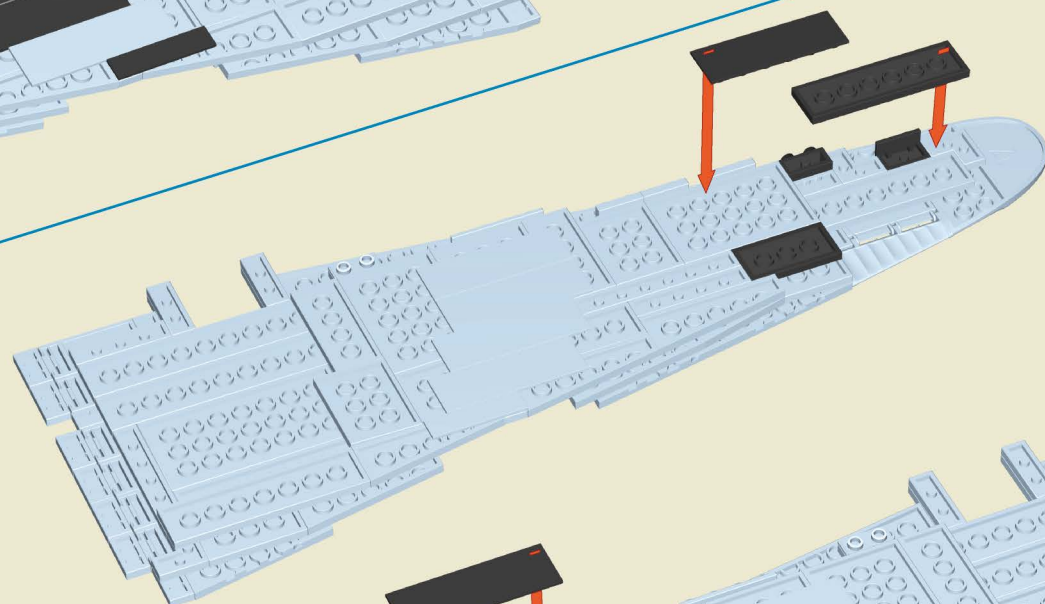

99

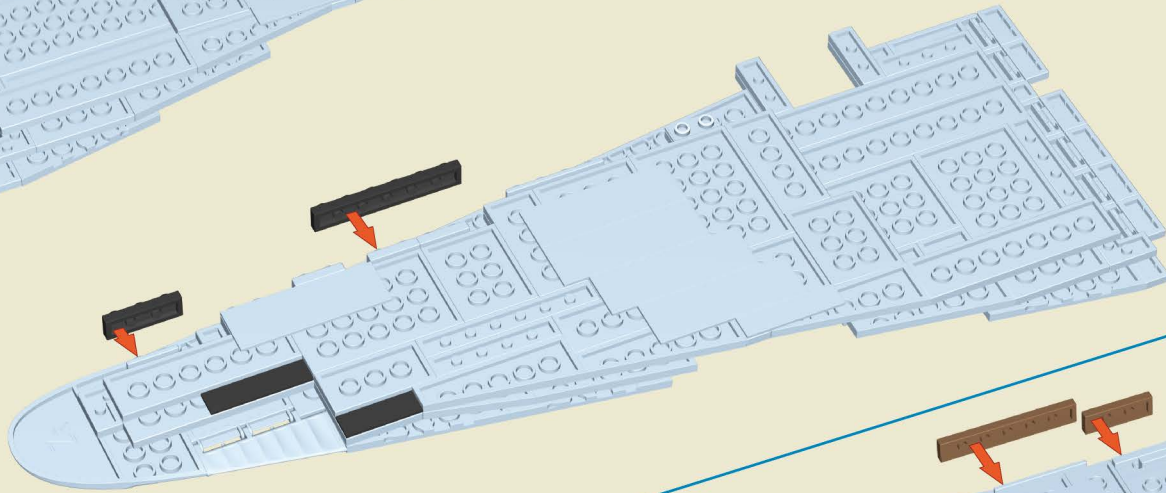
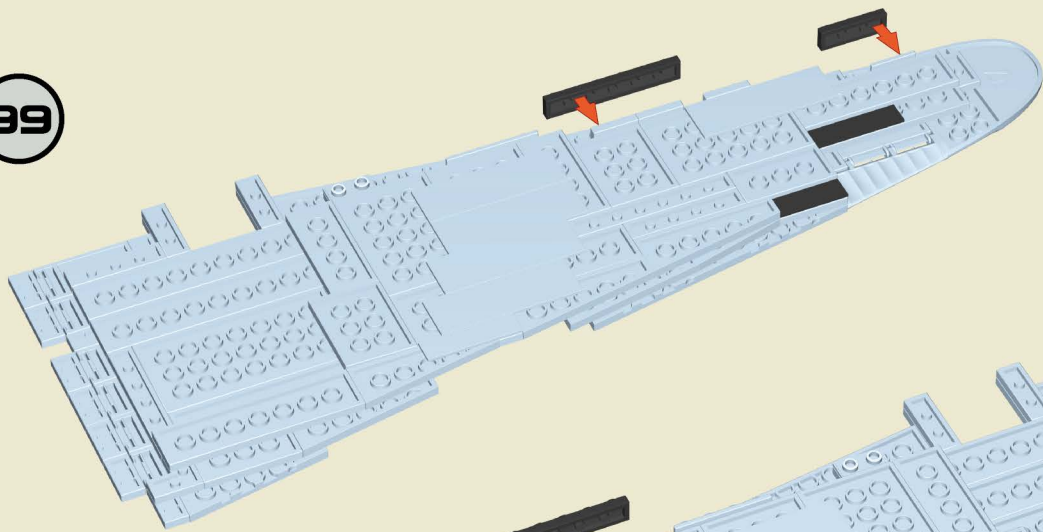



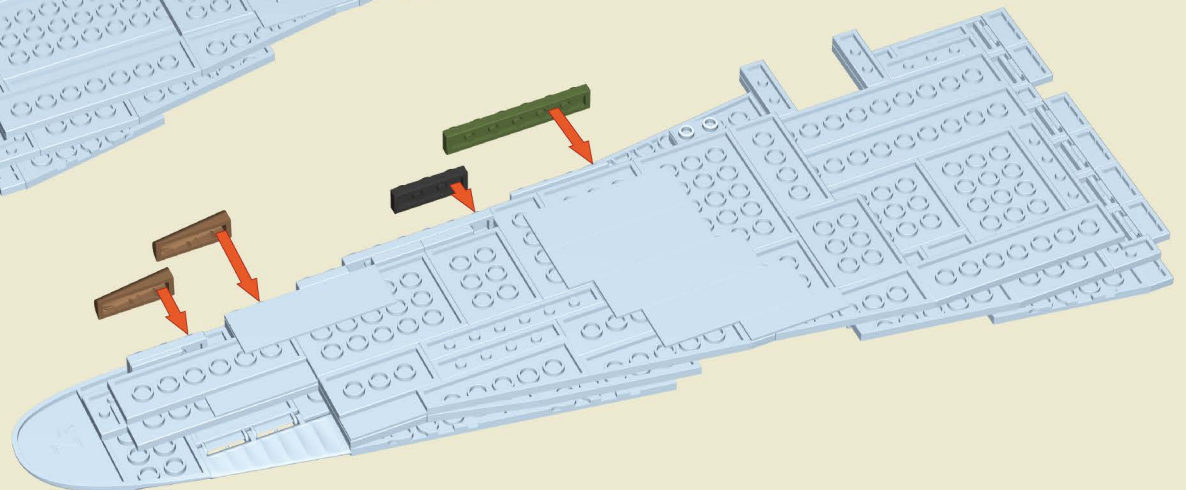



100

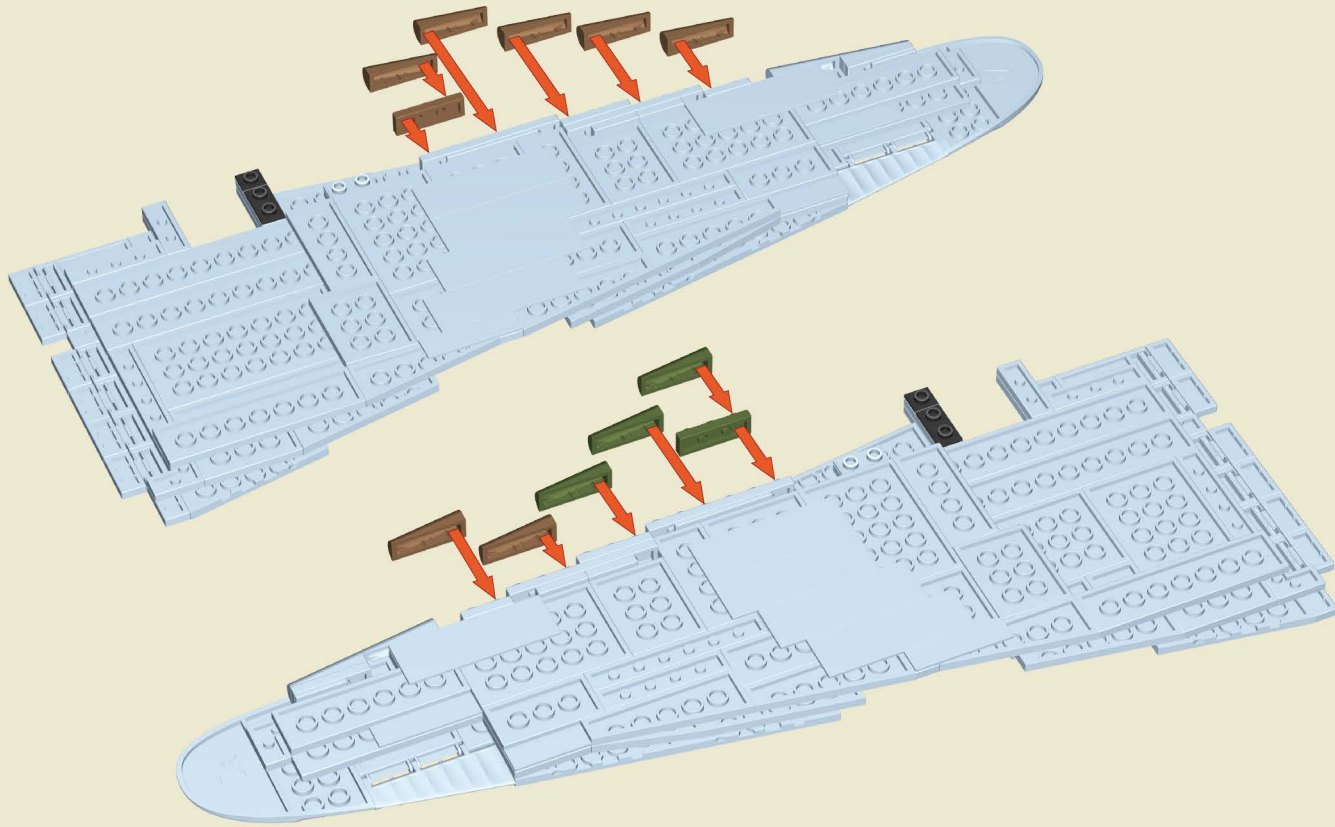



101



 x2	 x2
 x1	 x7
 x1	 x3

102

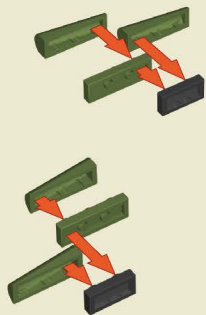

 x4
 x2
 x2

103

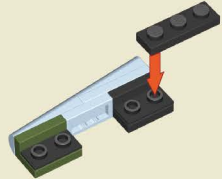
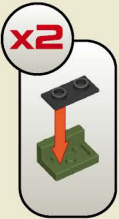

 x2
 x4
 x2
 x2

104

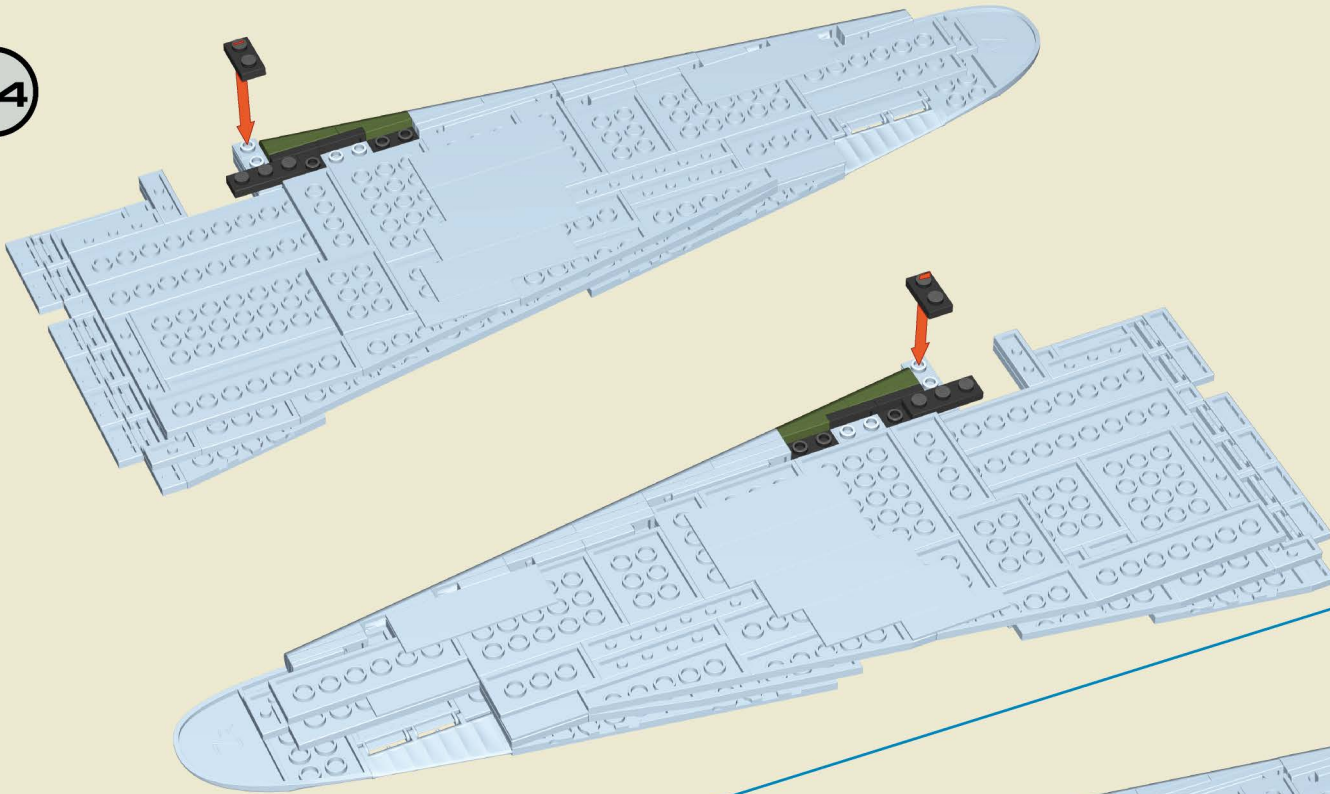

105

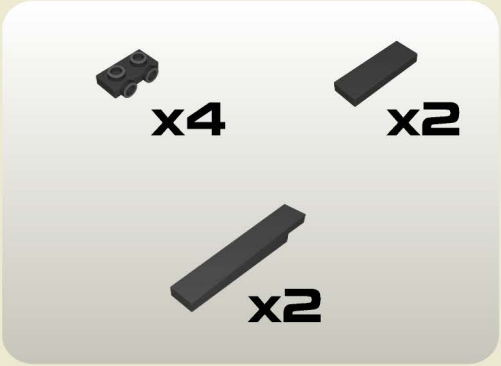
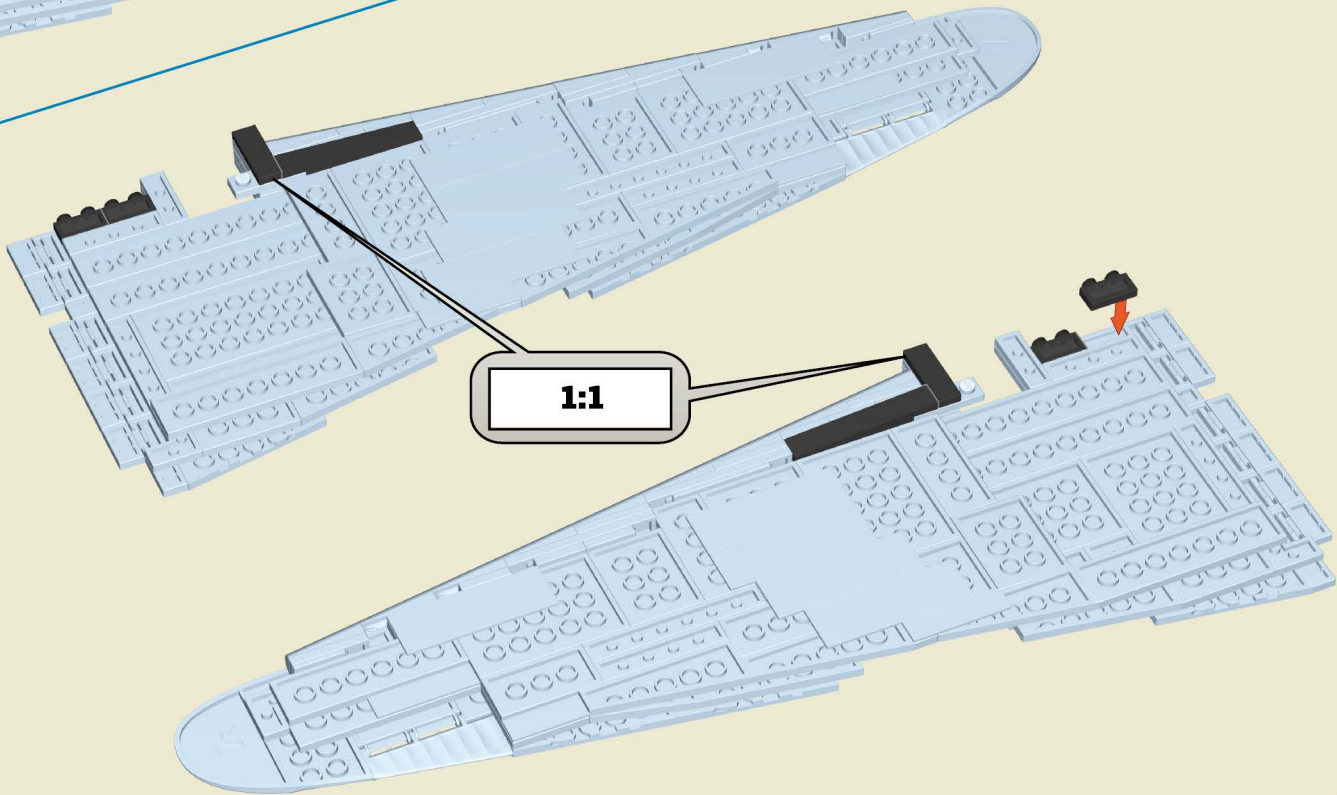

106



 x4

 x2

 x16

 x2

107

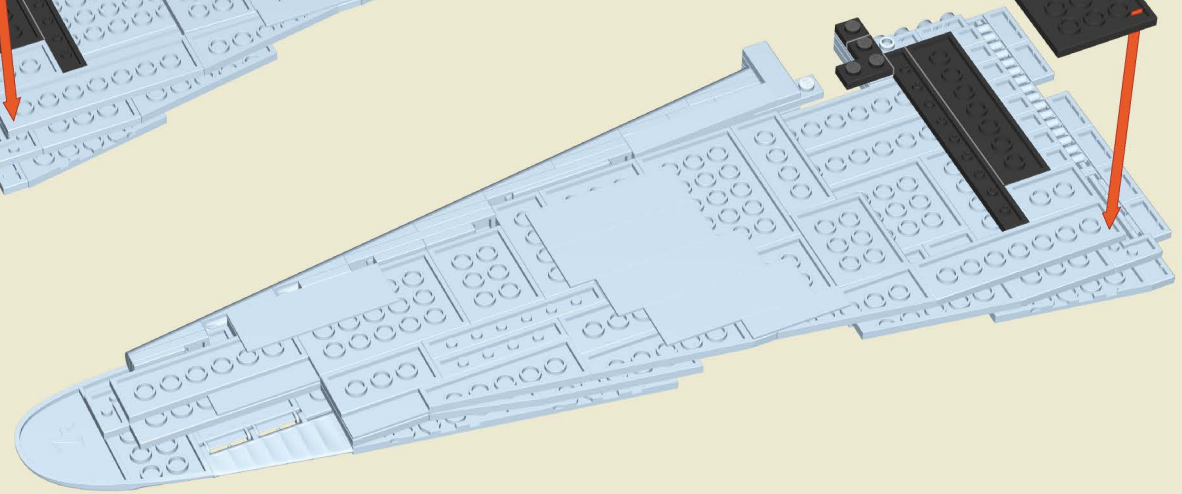
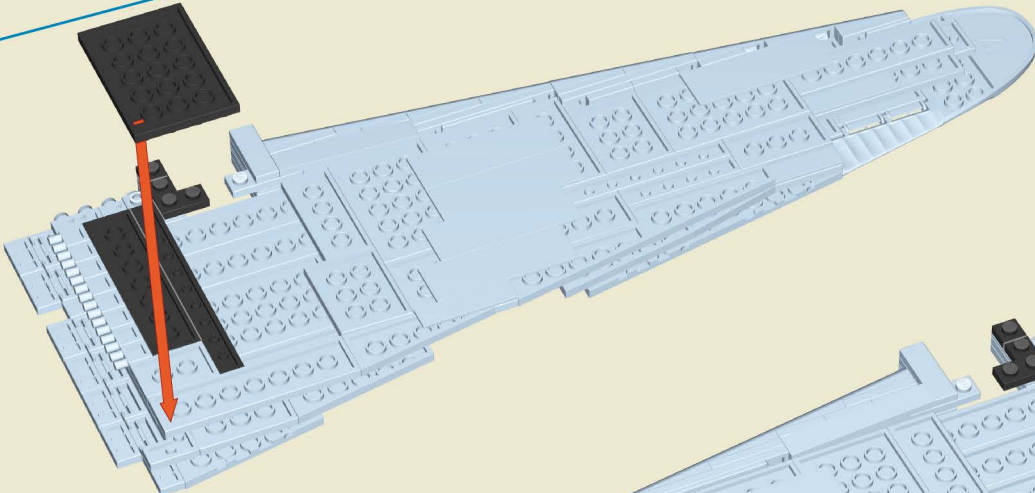

 x2

 x2

 x2

 x2

 x2



108

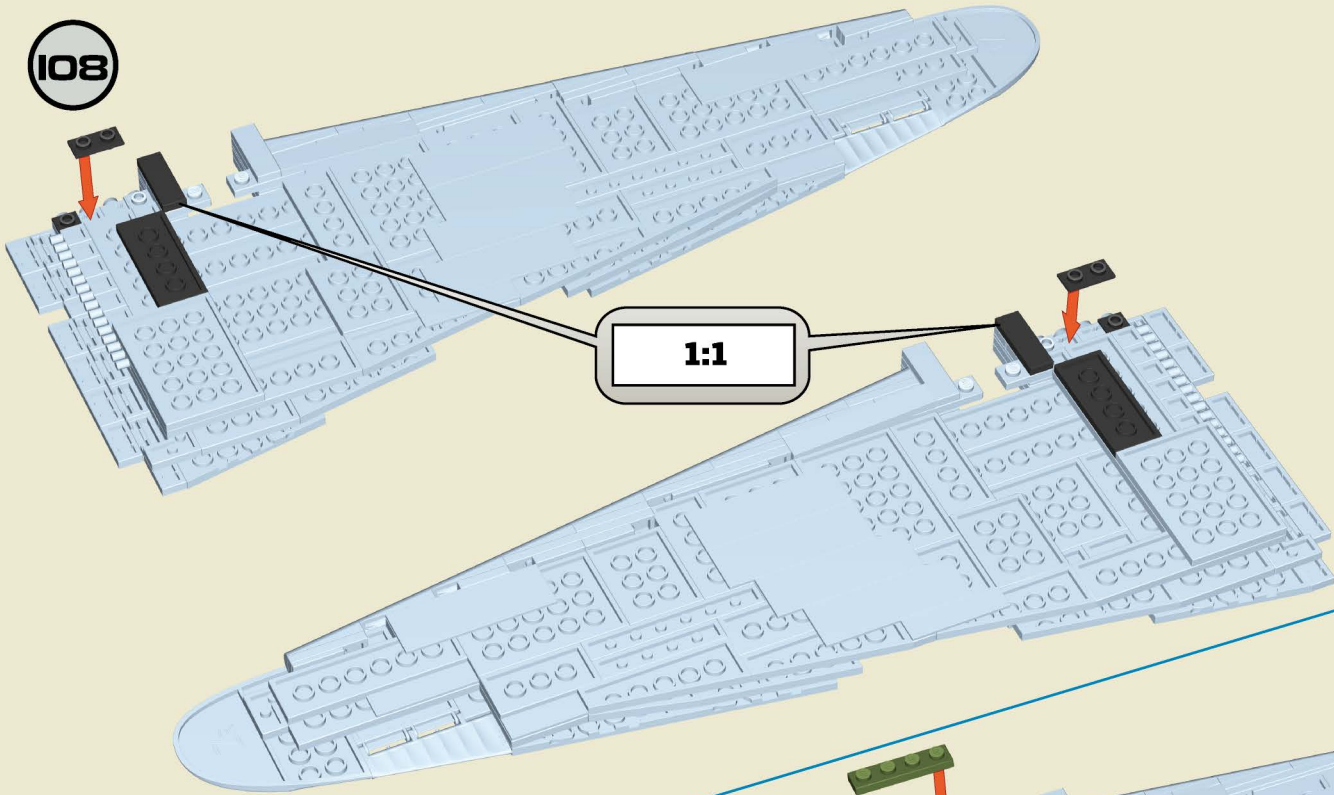

1:1

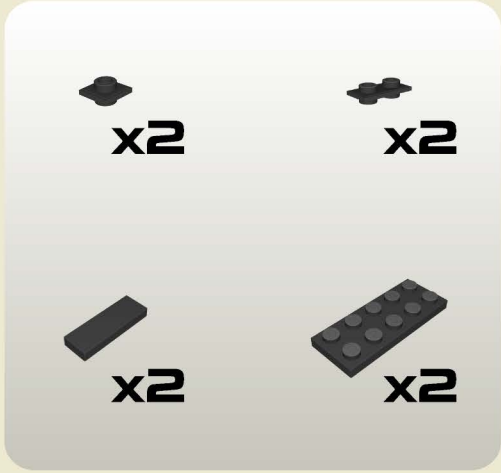

109

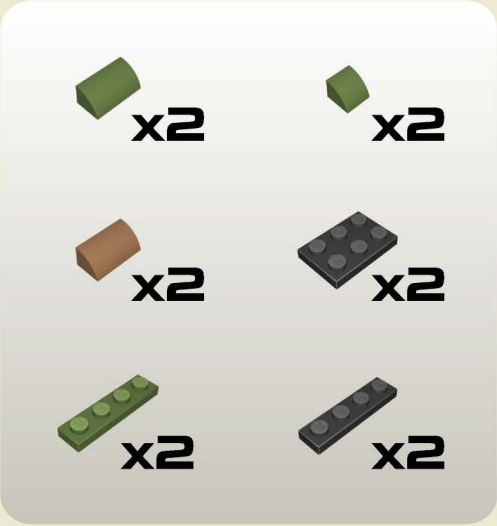
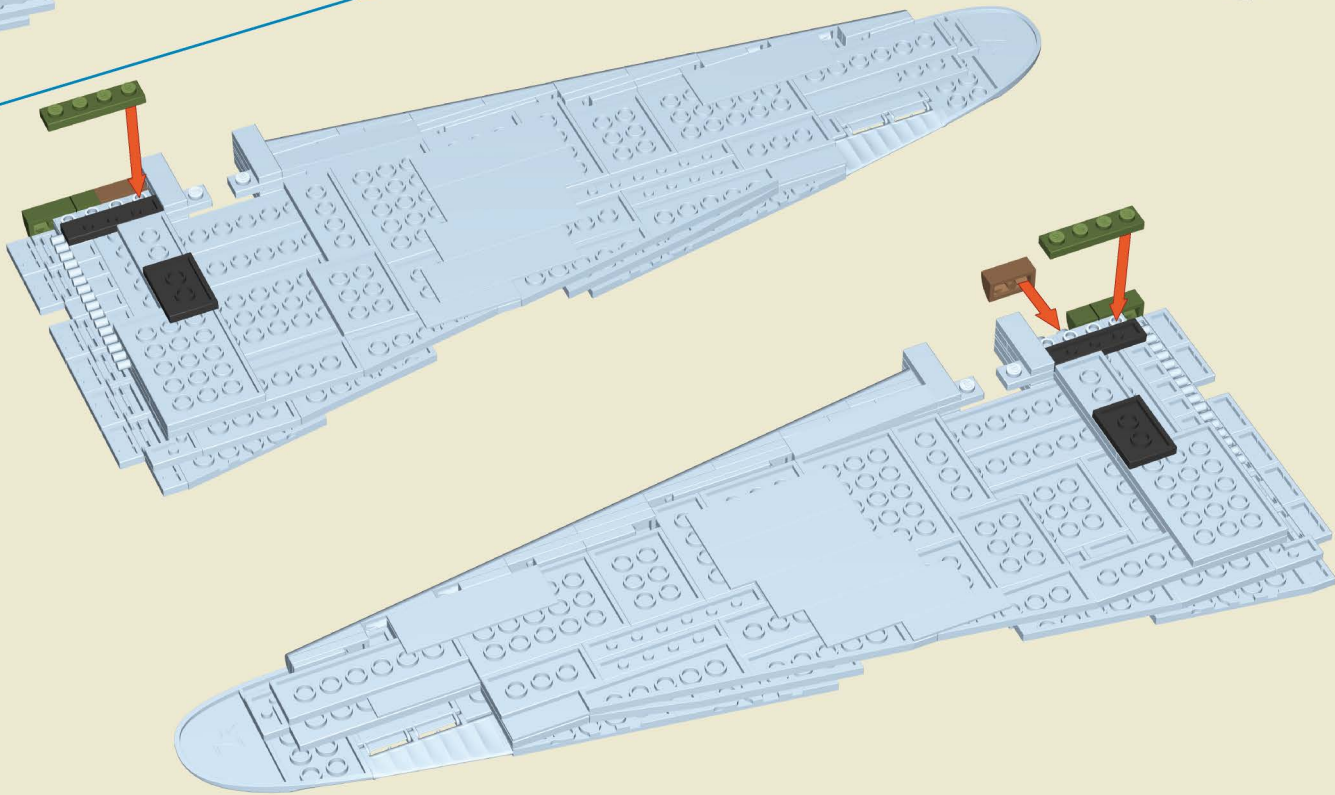



110

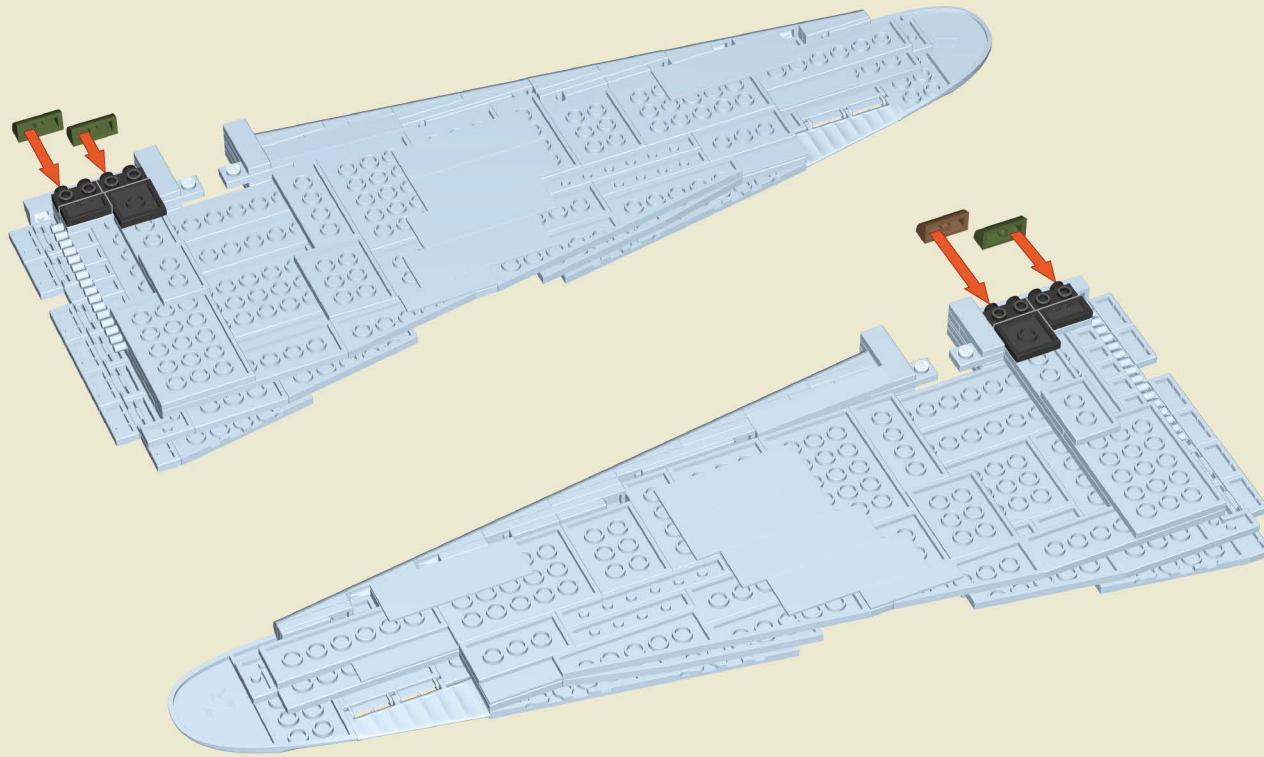

<b>x4</b>	<b>x3</b>
<b>x1</b>	<b>x2</b>
<b>x2</b>	

111

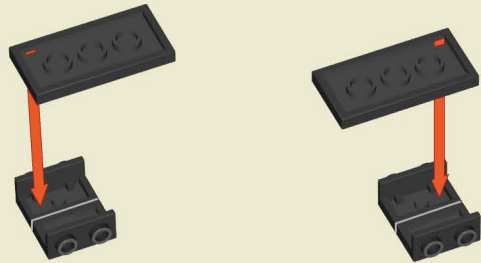

<b>x4</b>	<b>x2</b>

112



<b>x4</b>

113

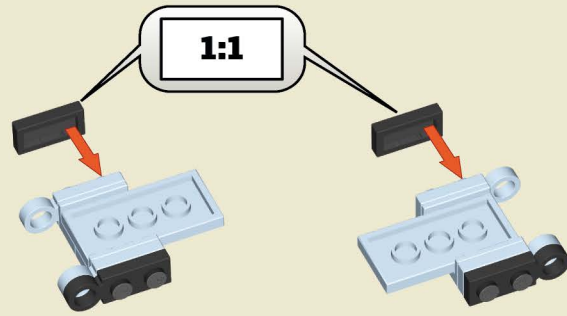

114

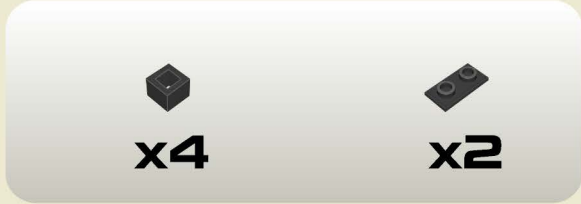
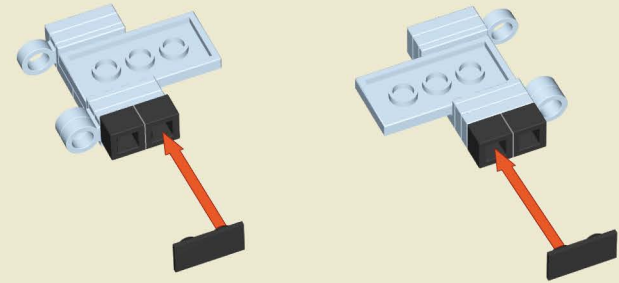

115

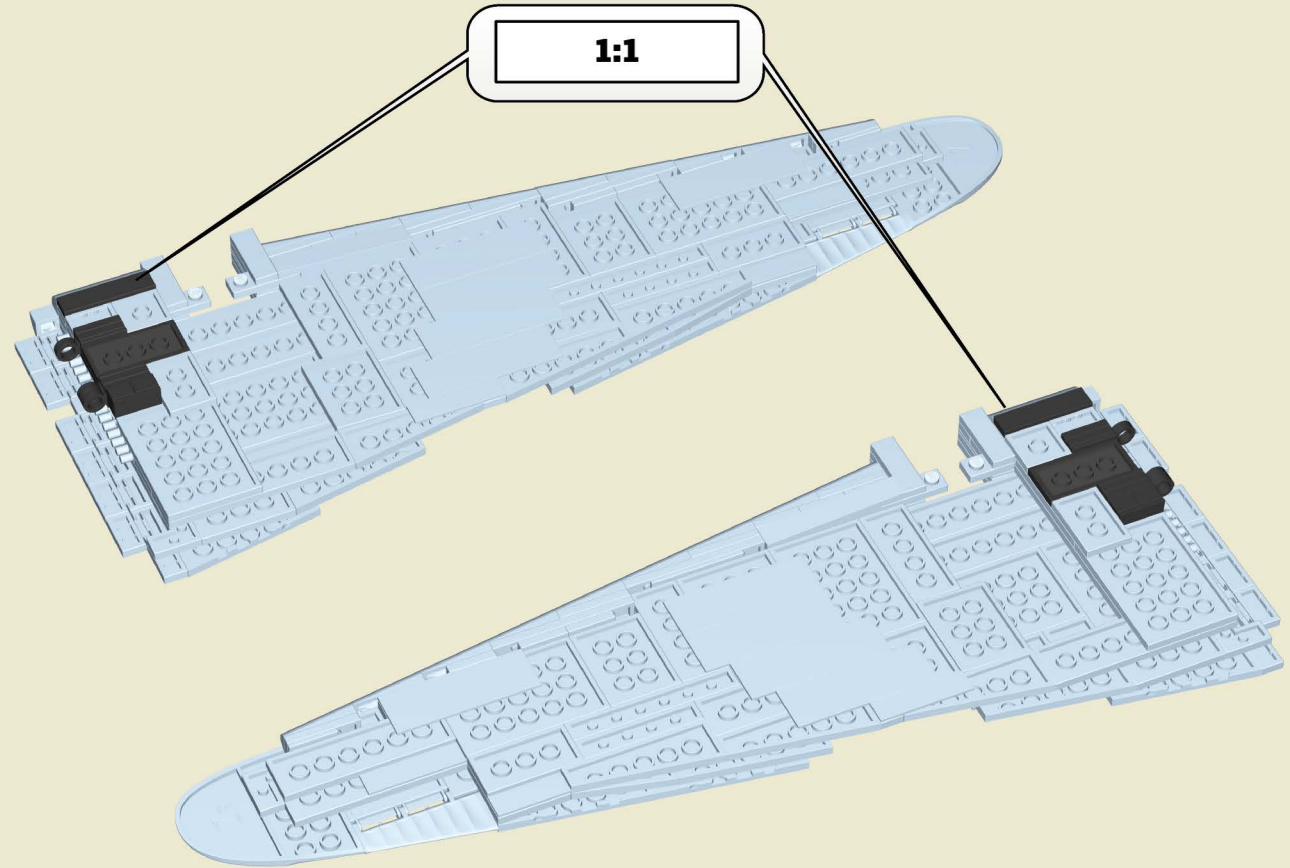



3

116

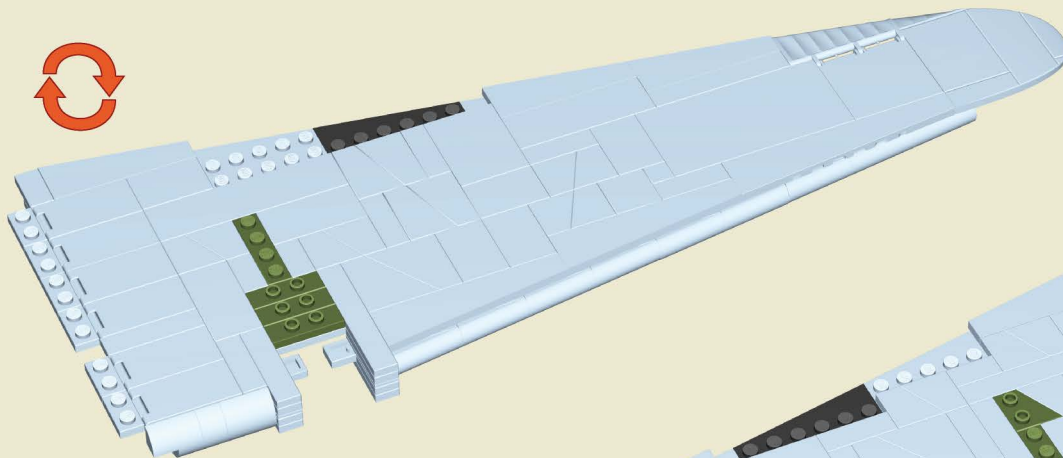

x1	x1
x3	x1
x1	x1
x3	



117



x1	x1
x1	x1
x1	x1







1:1

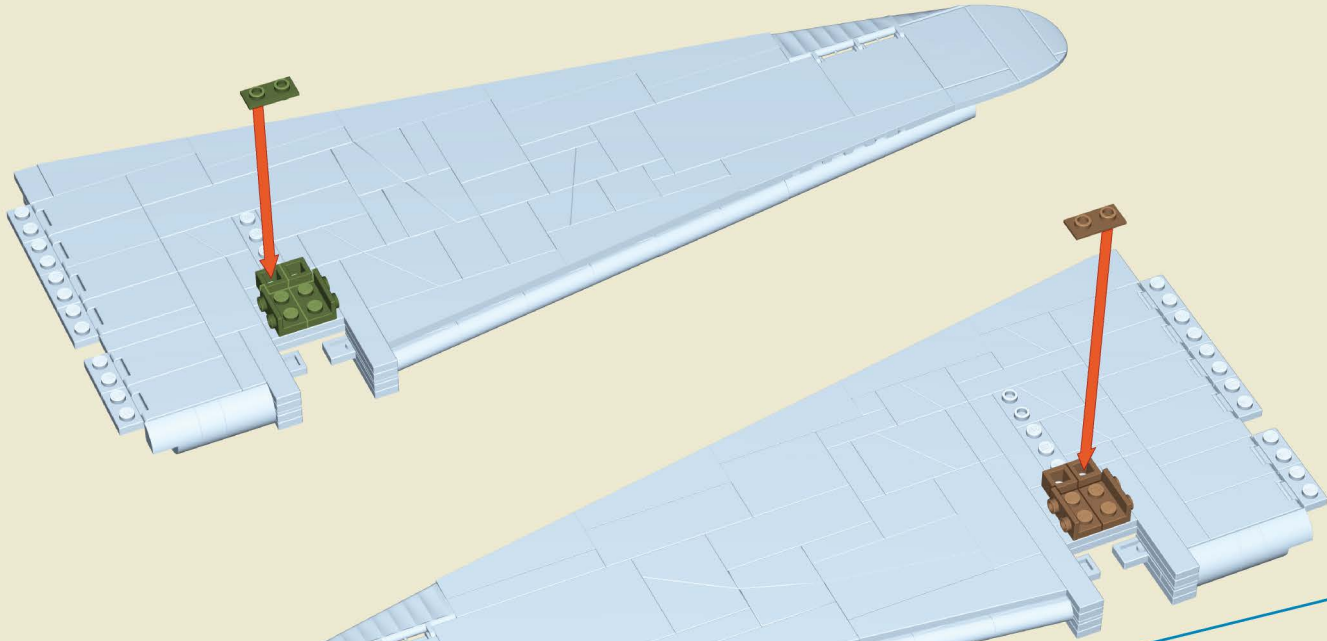



118



-  x2
-  x2
-  x1
-  x2
-  x2
-  x1

119

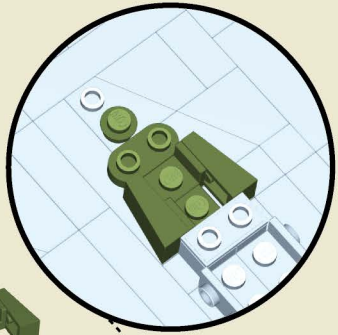
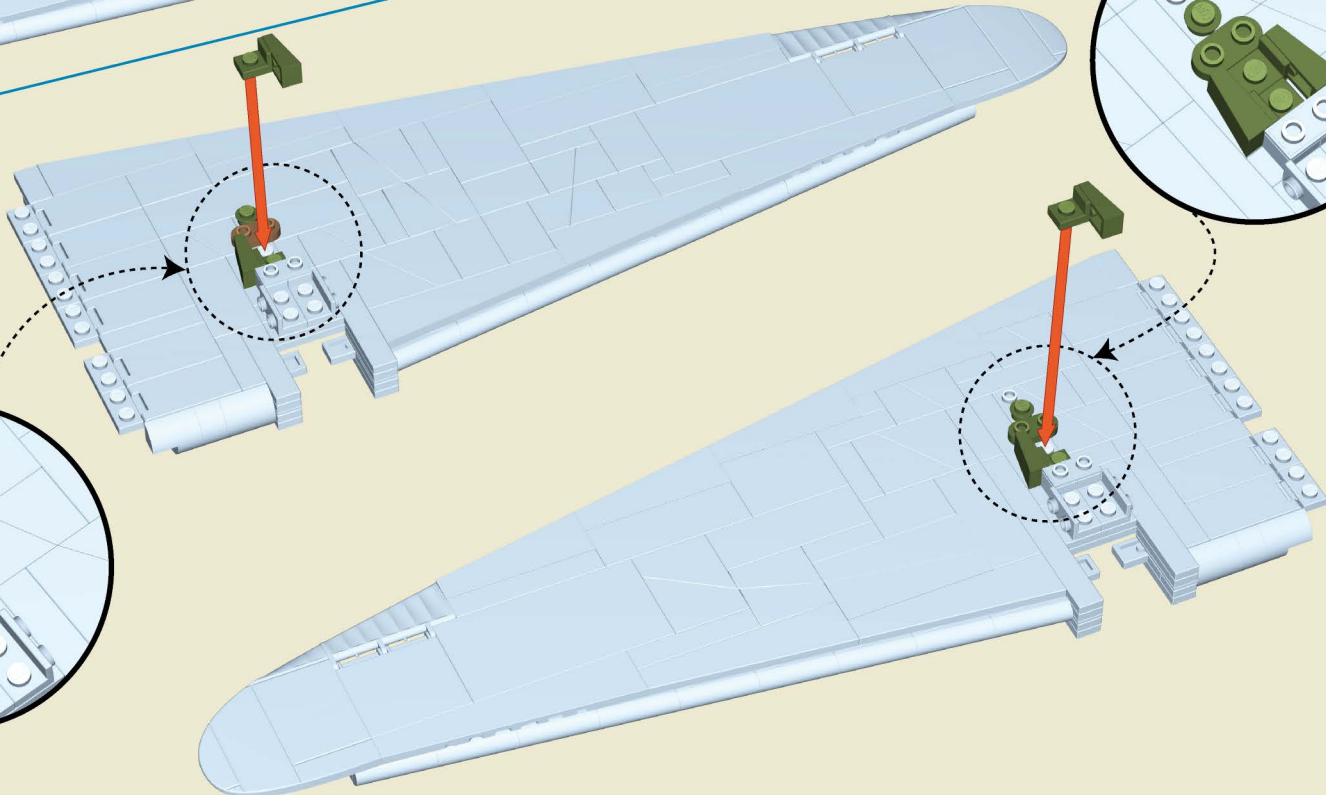

-  x2
-  x1
-  x4
-  x4
-  x1

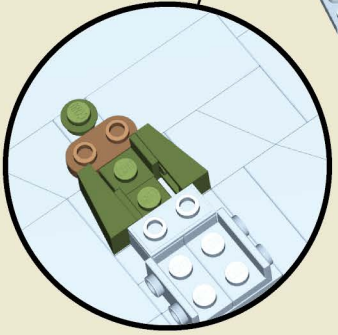
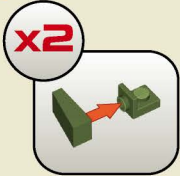



120

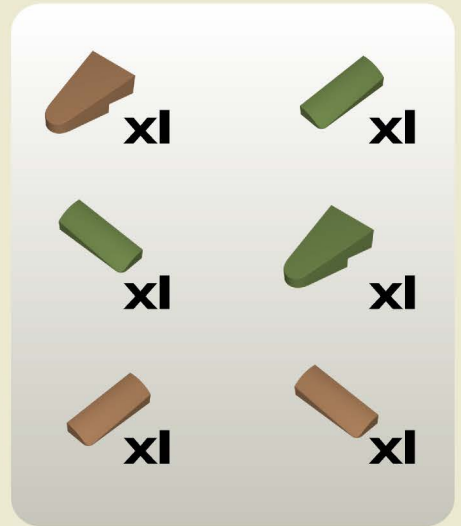
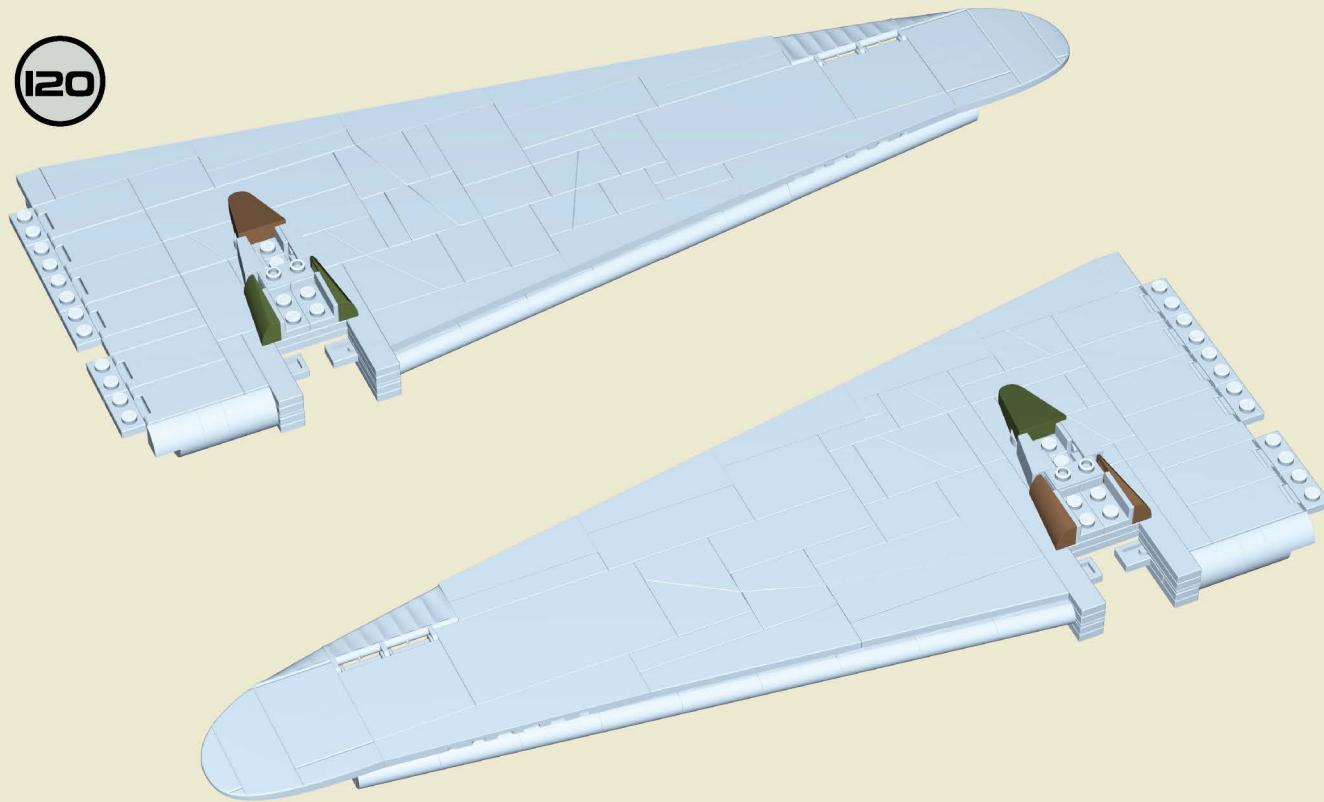

121



x2

x2

x2

122



x2

x4

123

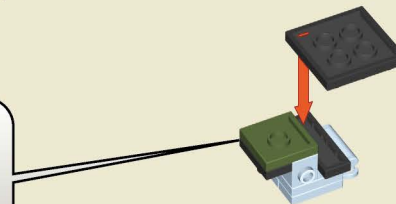
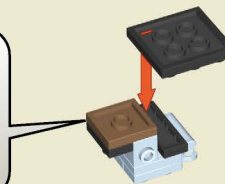

x2

x2

x1

x2

x1

124

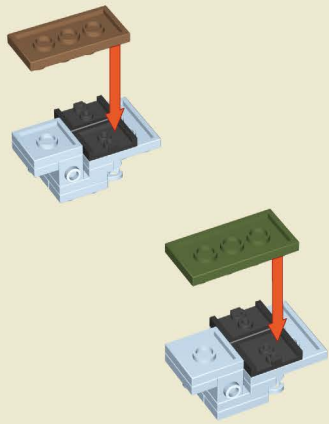

x4

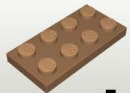

x1

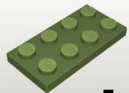

x1

125

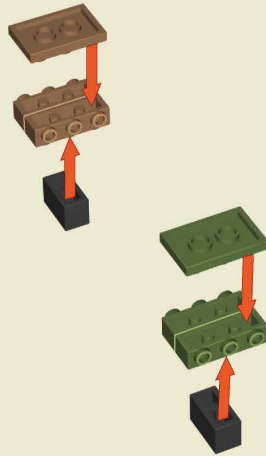

x2



x1



x2



x2

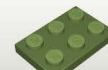

x1

126

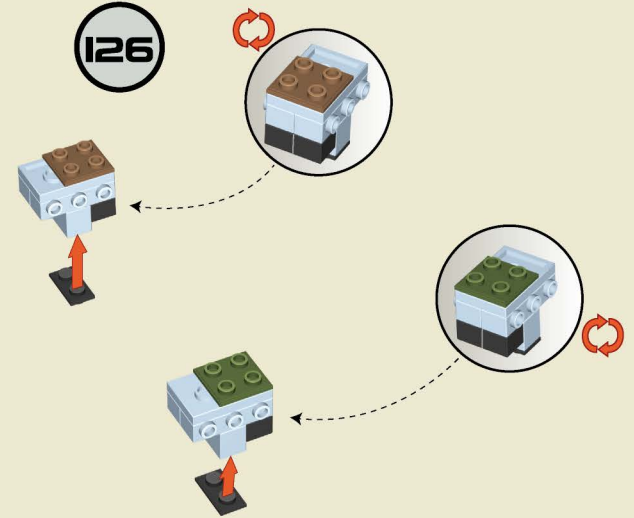

x2



x4



x1



x1

127

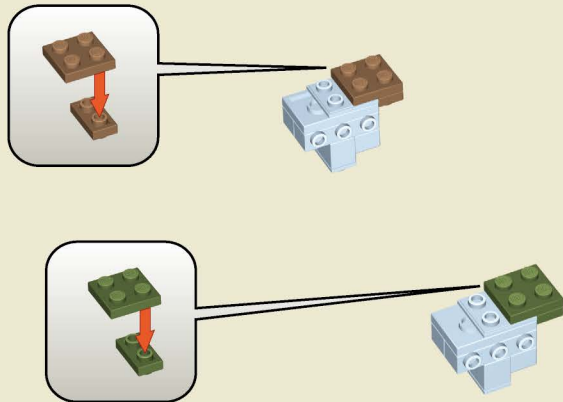

x1



x1



x1



x1

128

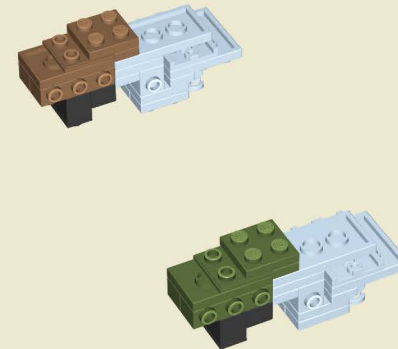

129

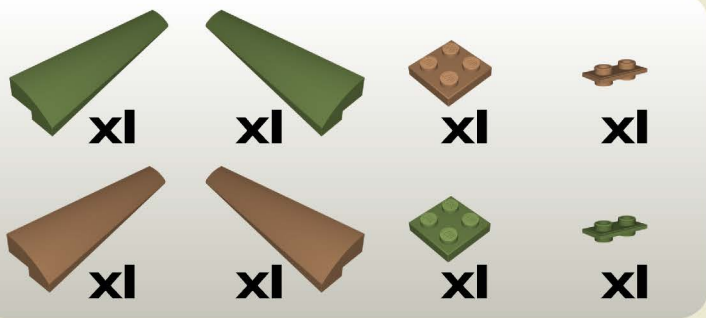
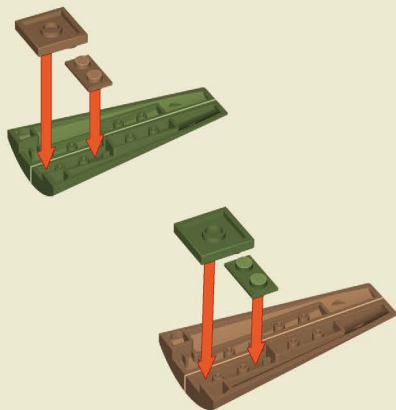

130

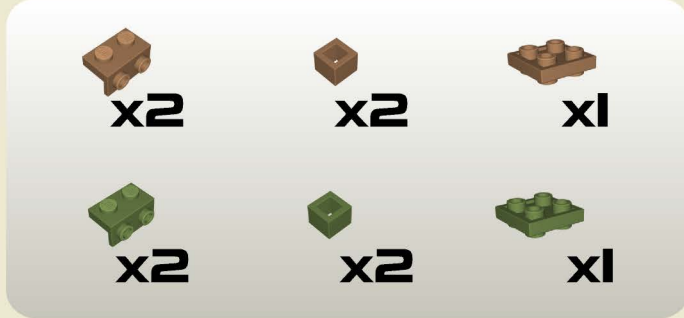
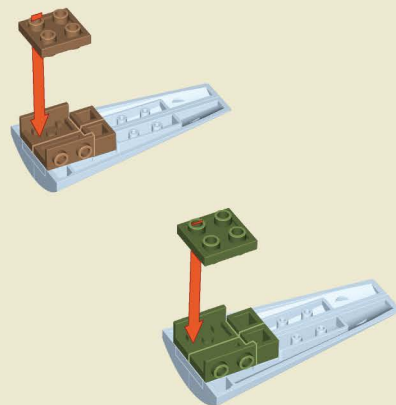

131

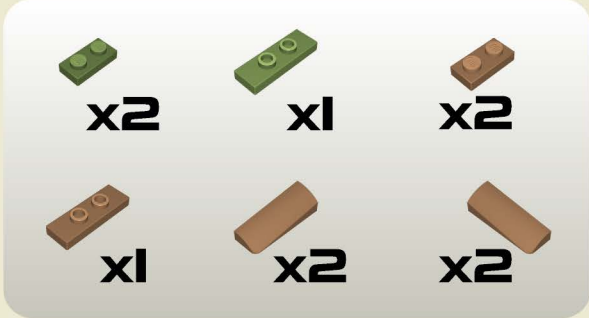
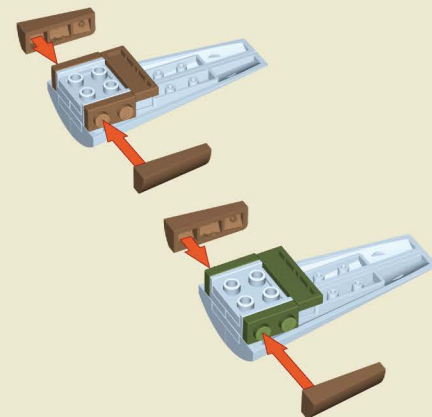

132

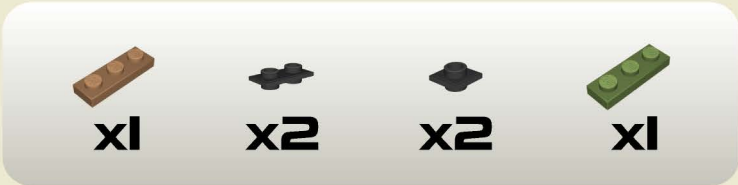
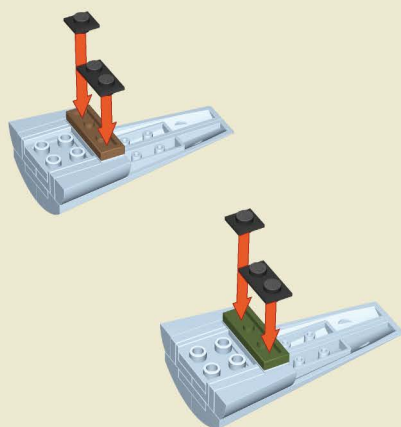

133

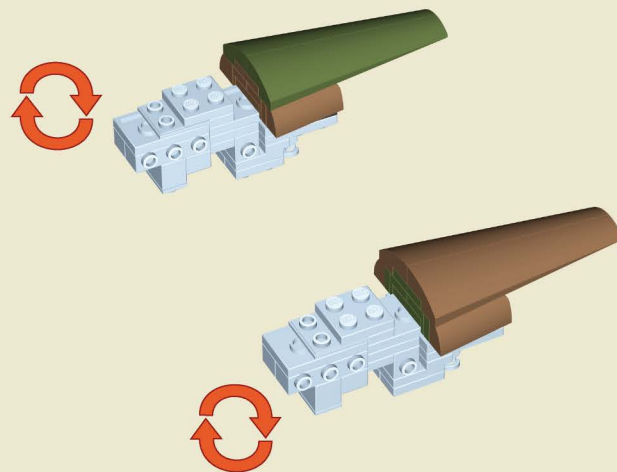

134

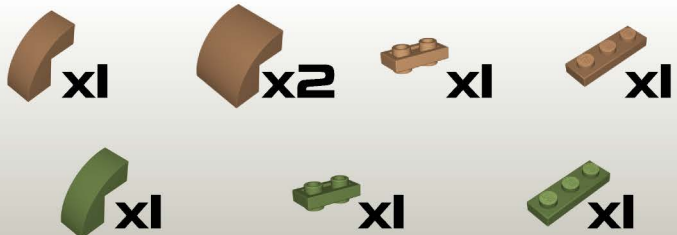
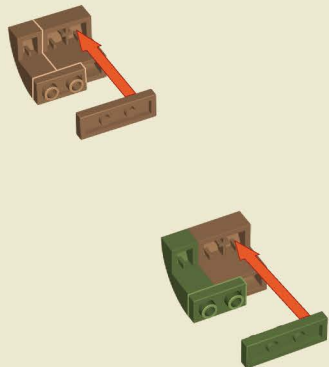

135

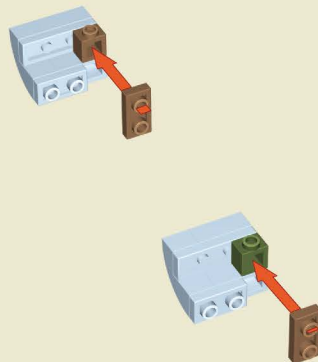

136

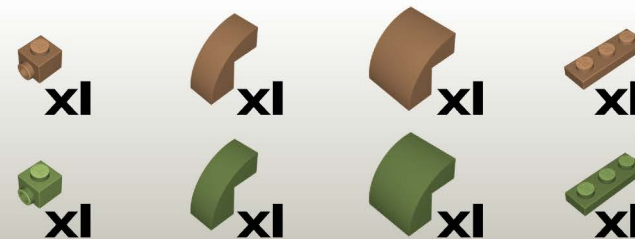
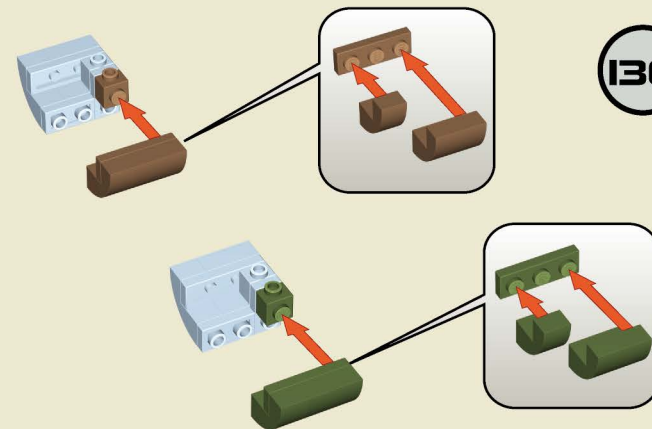

137

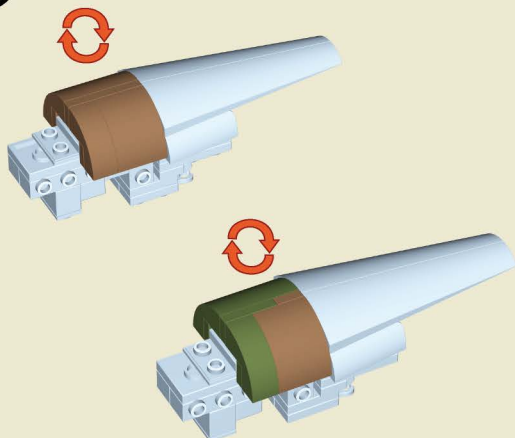

138

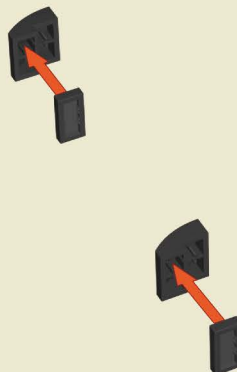

139

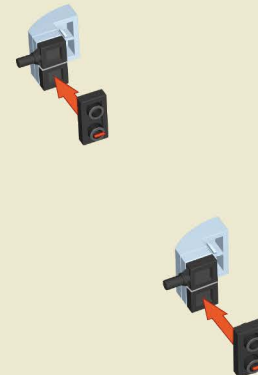



140

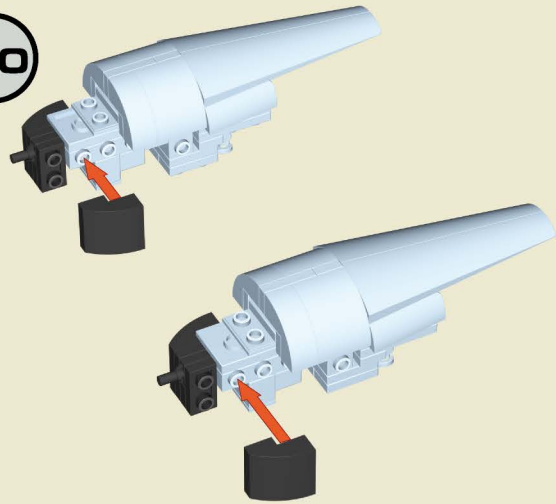

x2

141

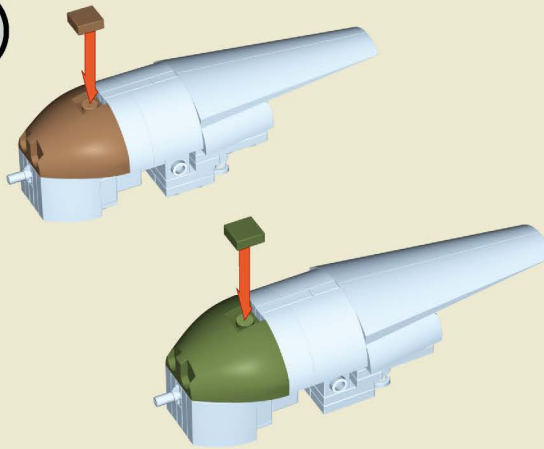

x1



x1

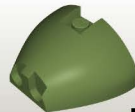

x1



x1

142 x2

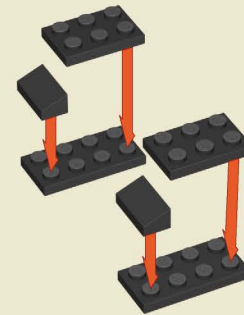

x2

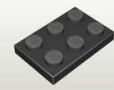

x2



x2

143 x2

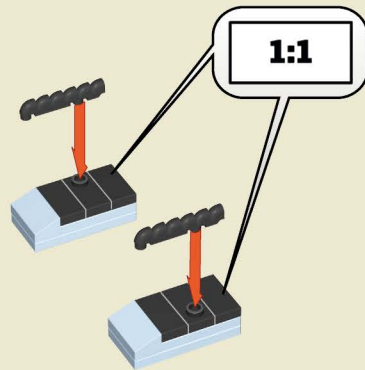

x4



x2



x2

144

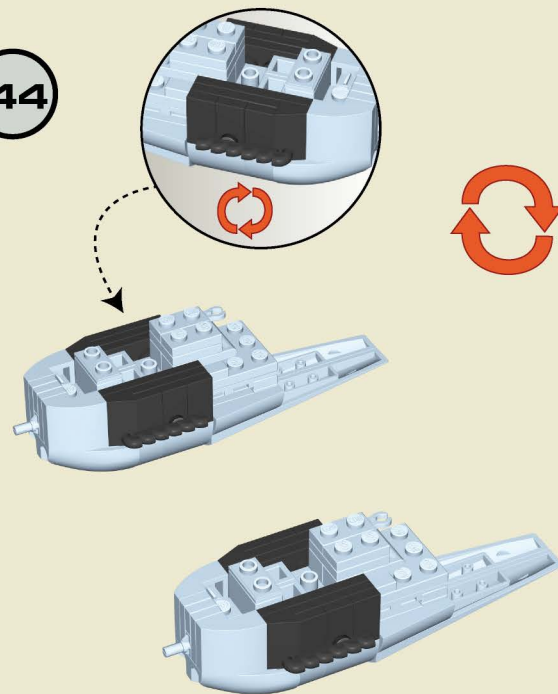

145

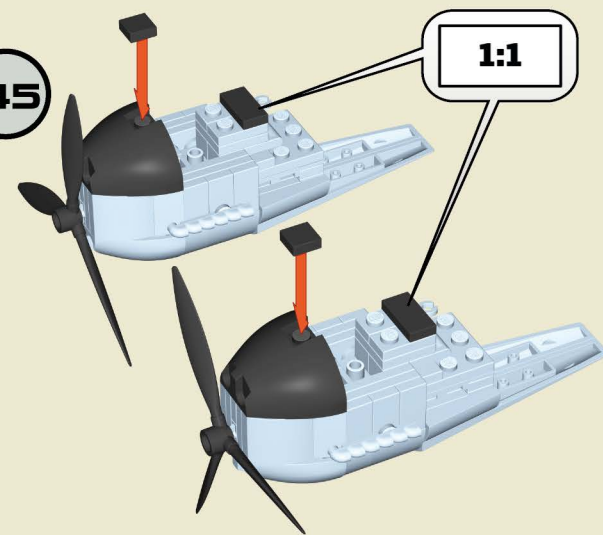

x2



x2



x2



x2

146

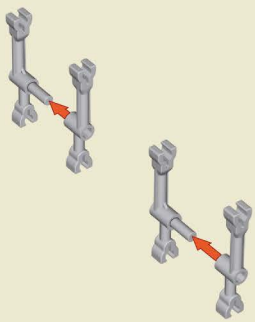

147

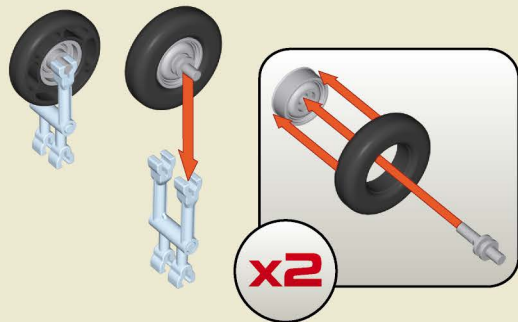

148

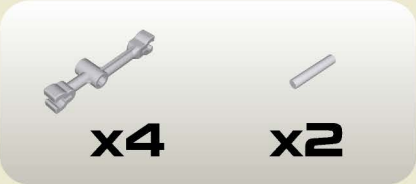
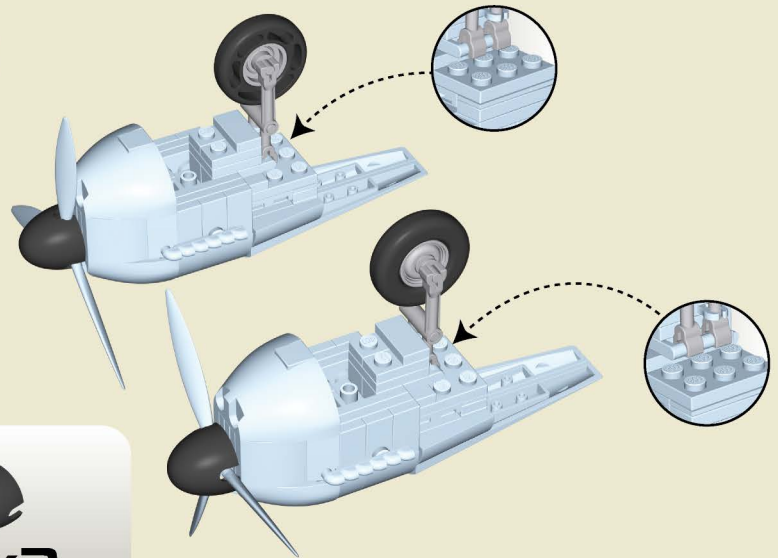

149

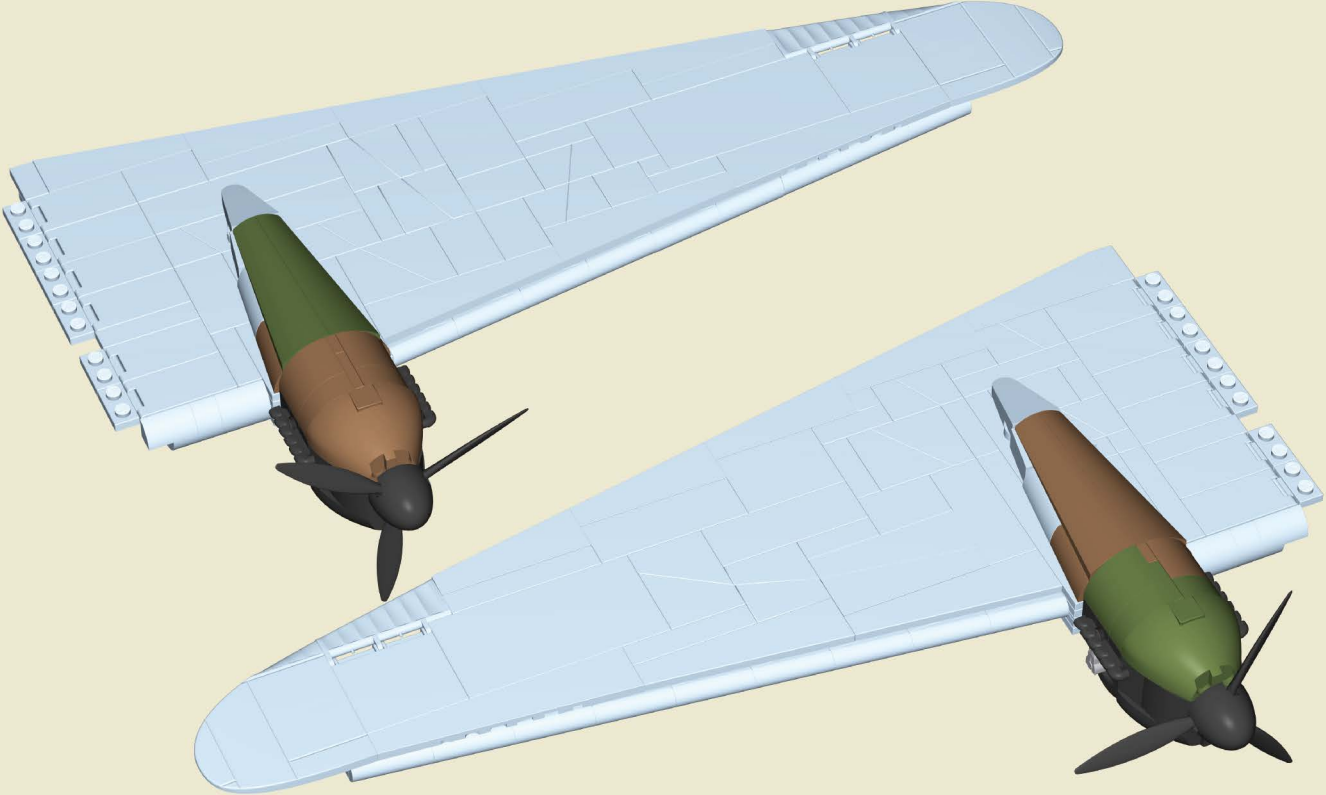

150 x2

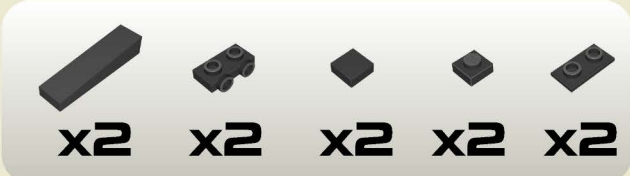
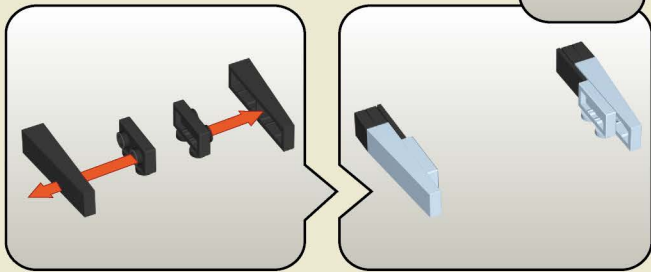
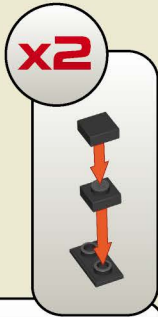

151

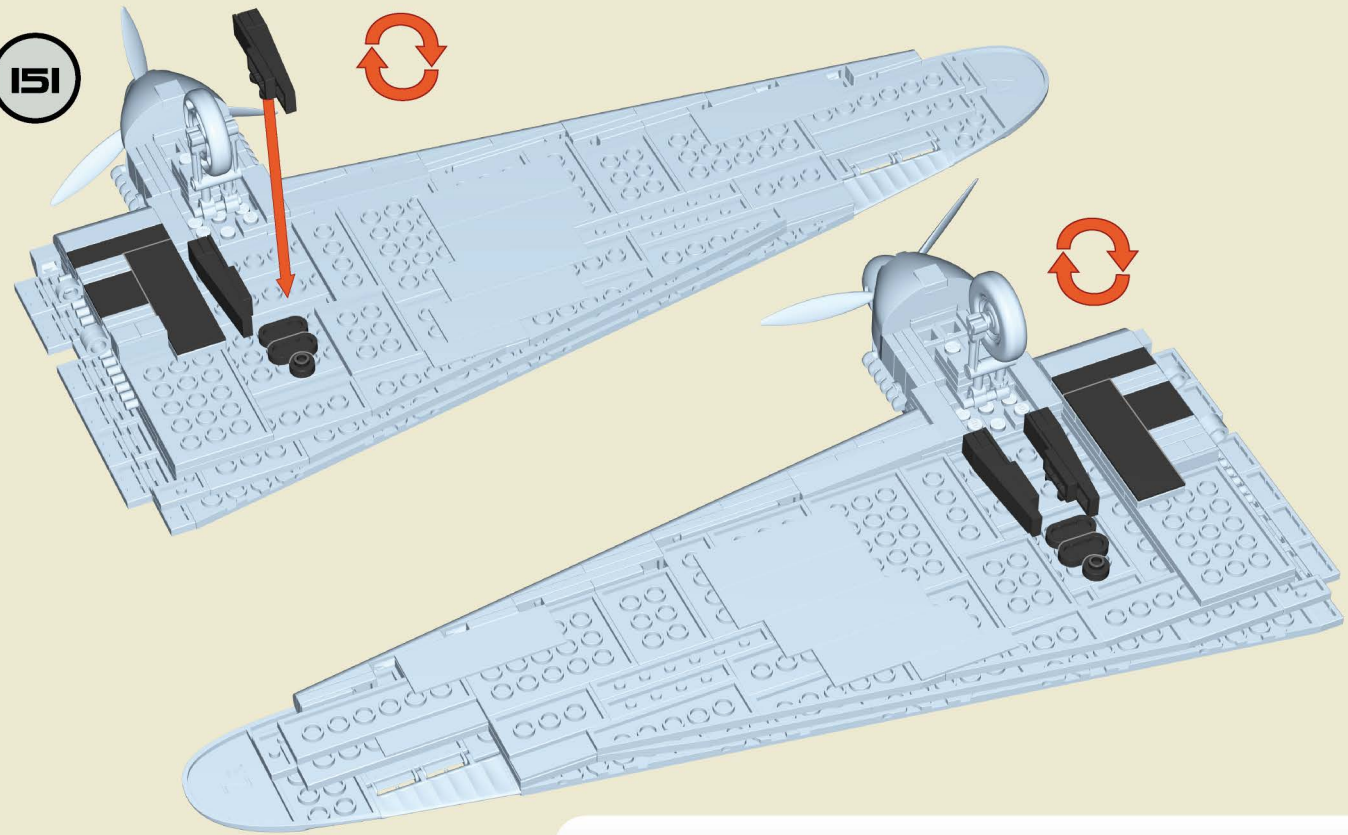

152

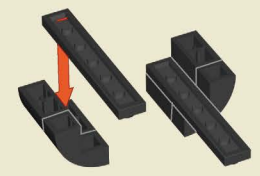

152 155 x2



153

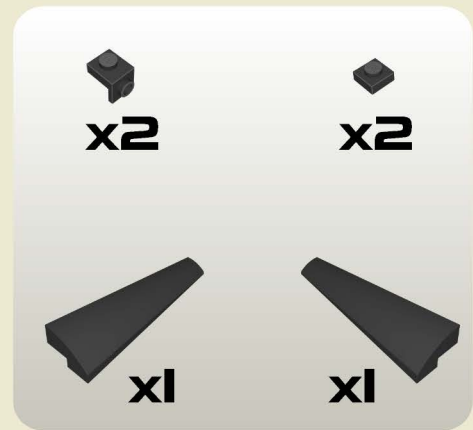
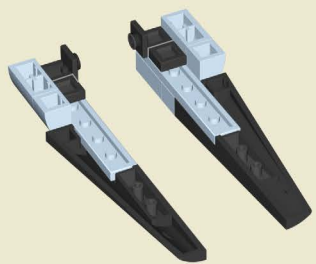



154

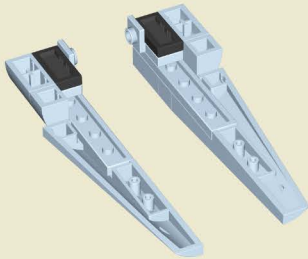

x2

155

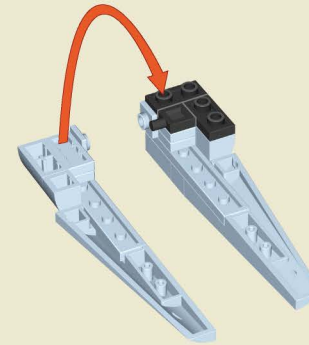

x1



x2

156

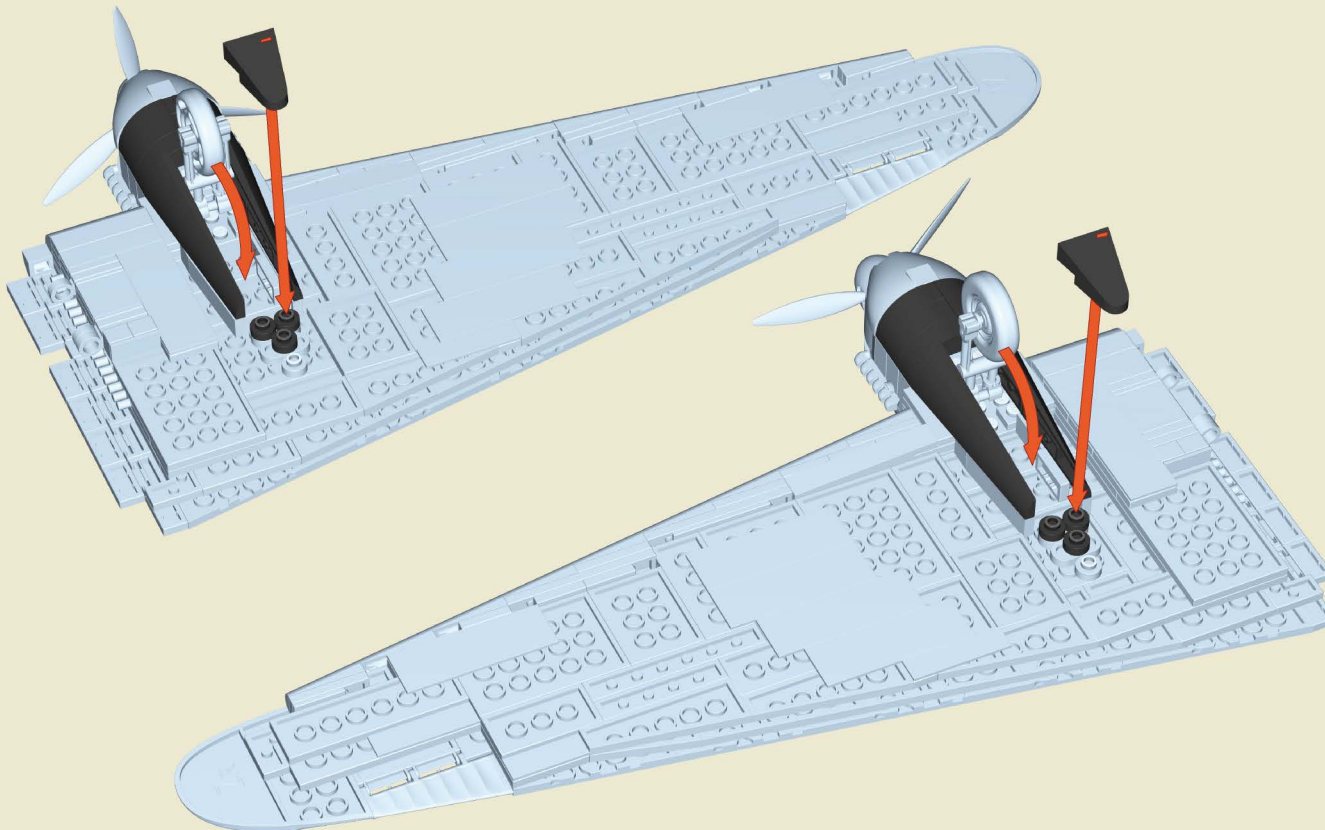

x6





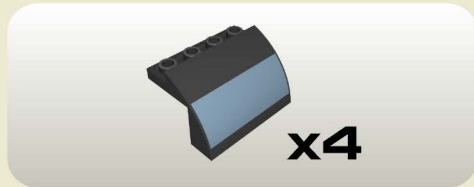
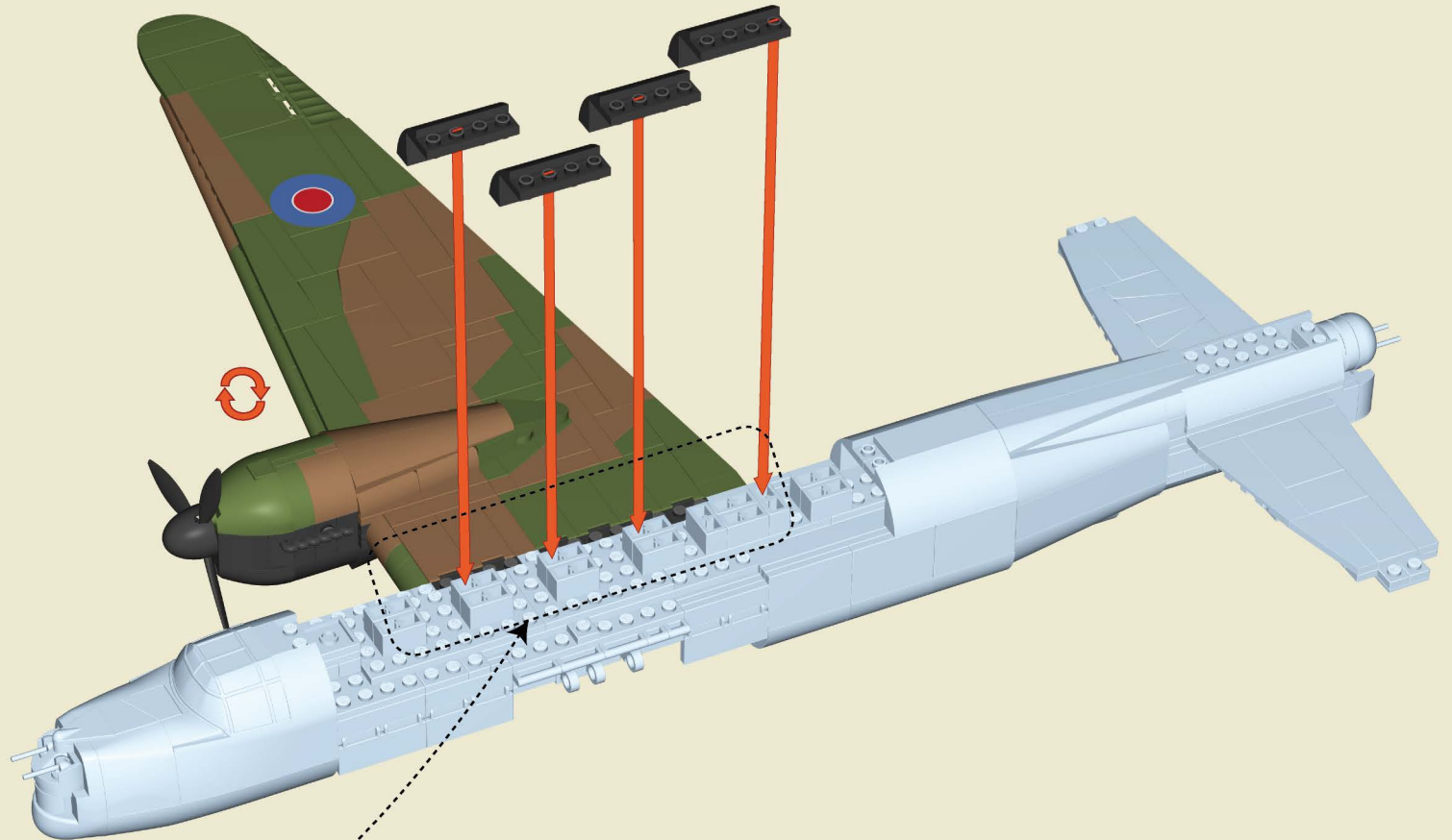
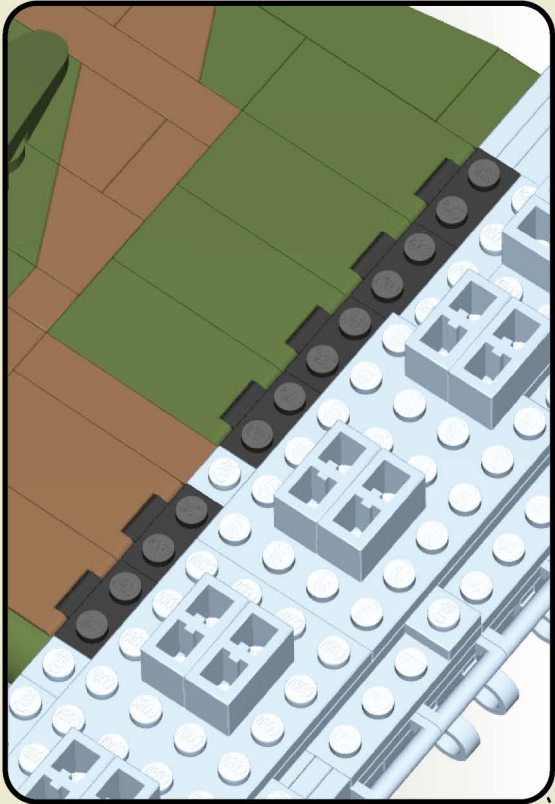

x2

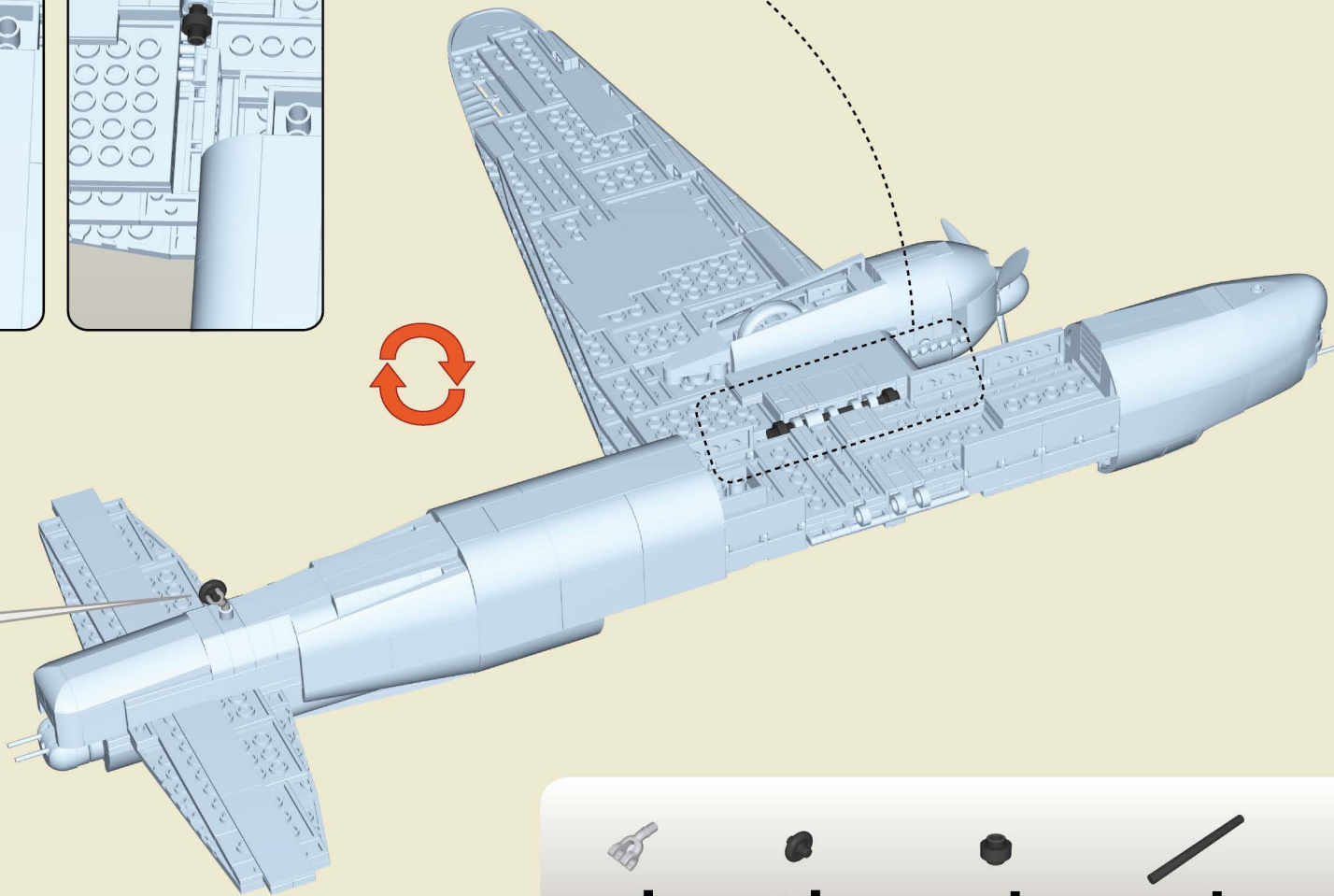
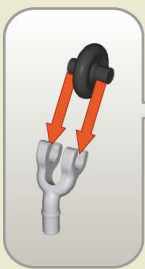
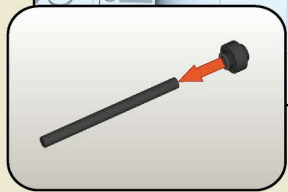
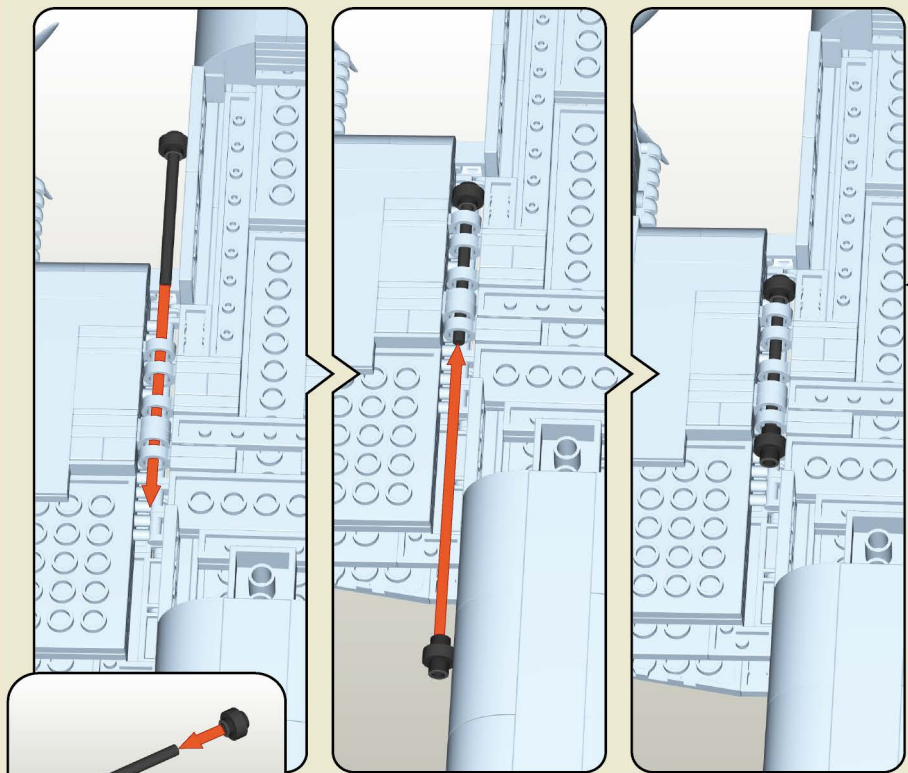

158



-  **x1**
-  **x1**
-  **x1**
-  **x1**
-  **x1**



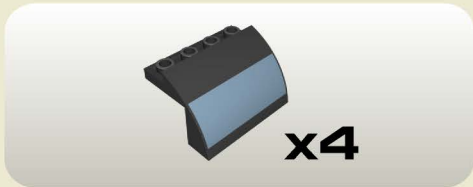
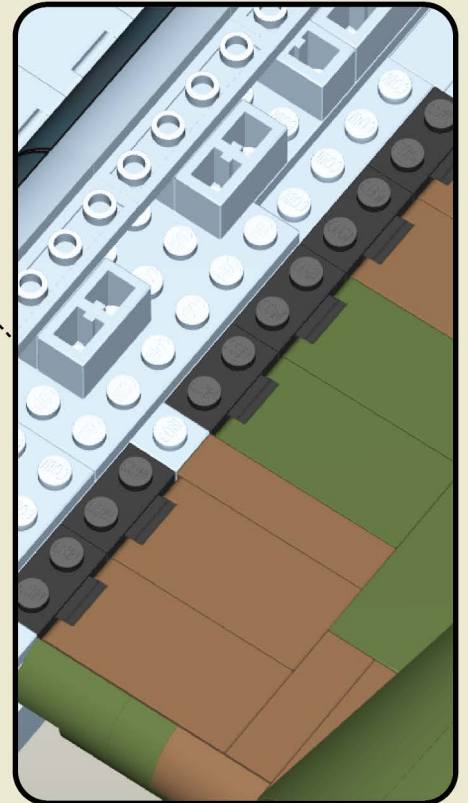
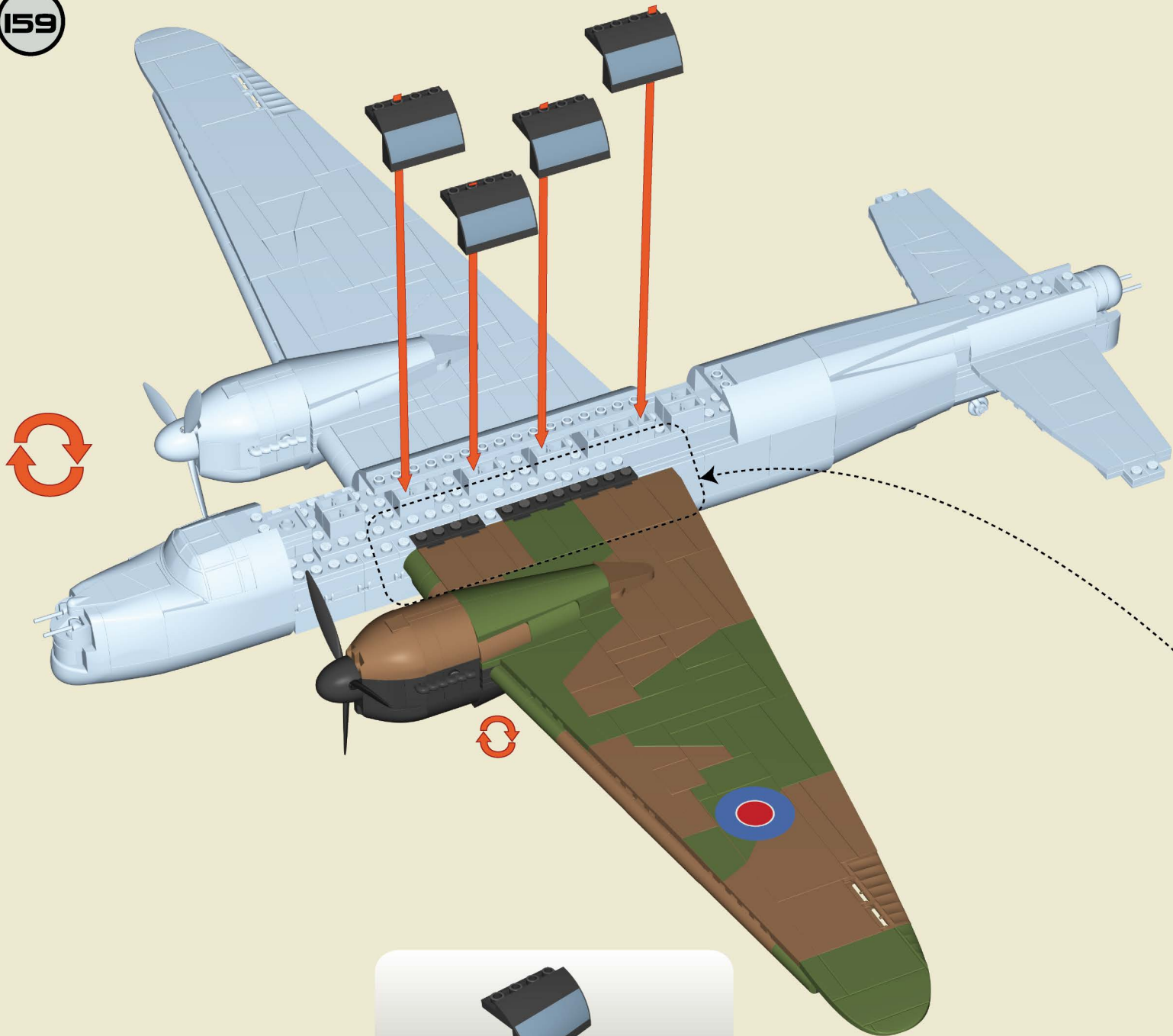

160

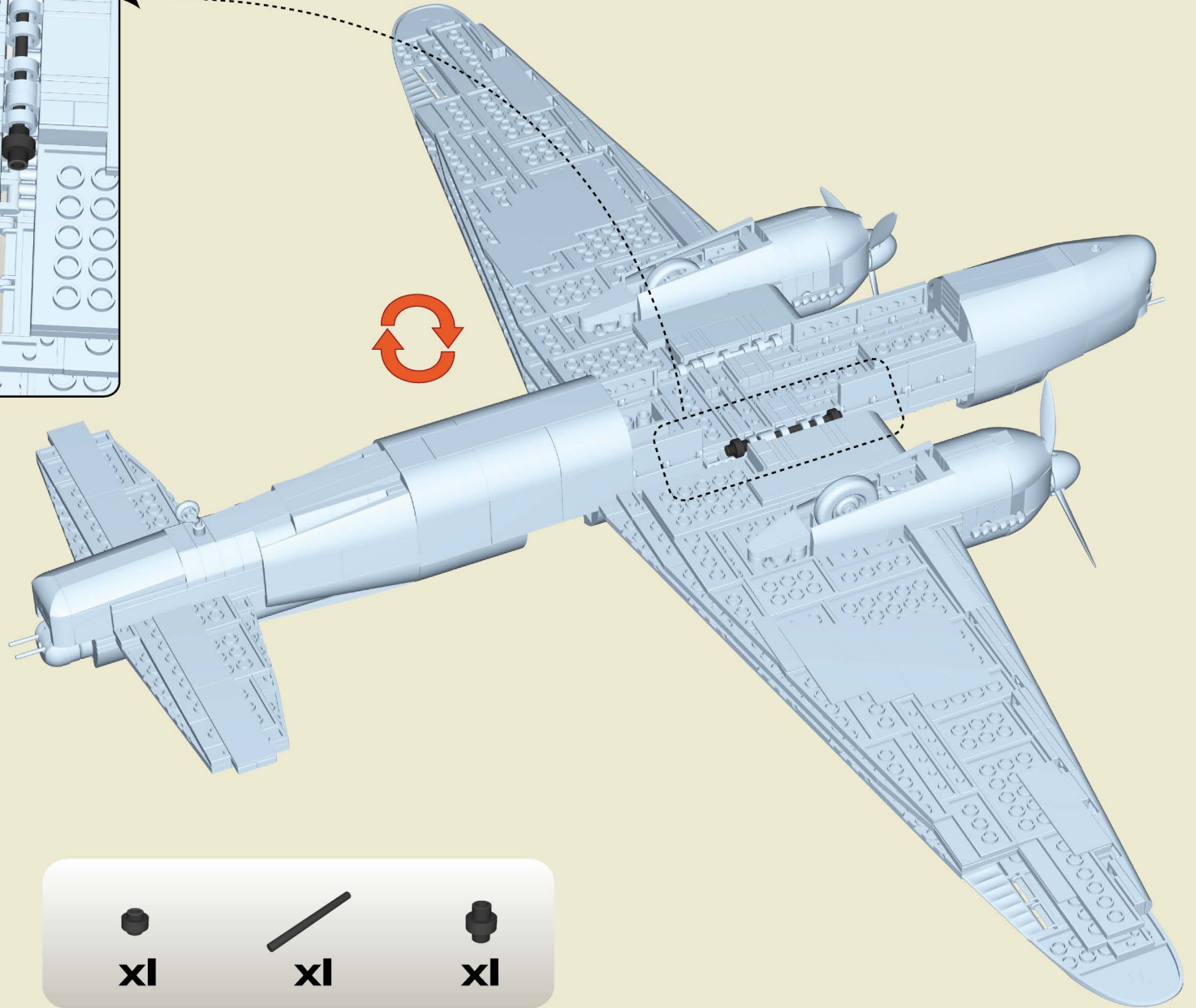
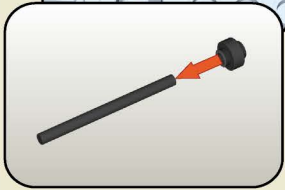
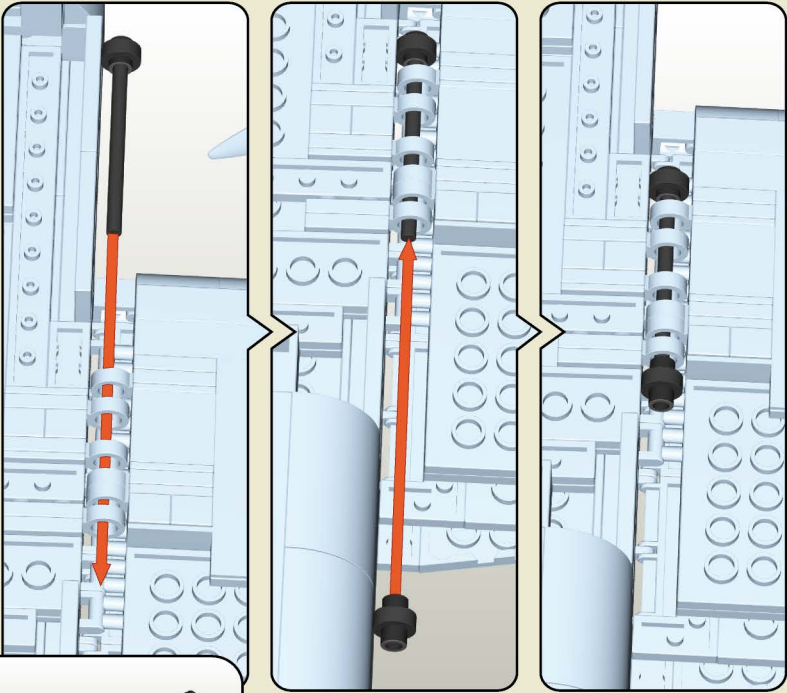

x1



x1



x1

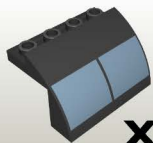
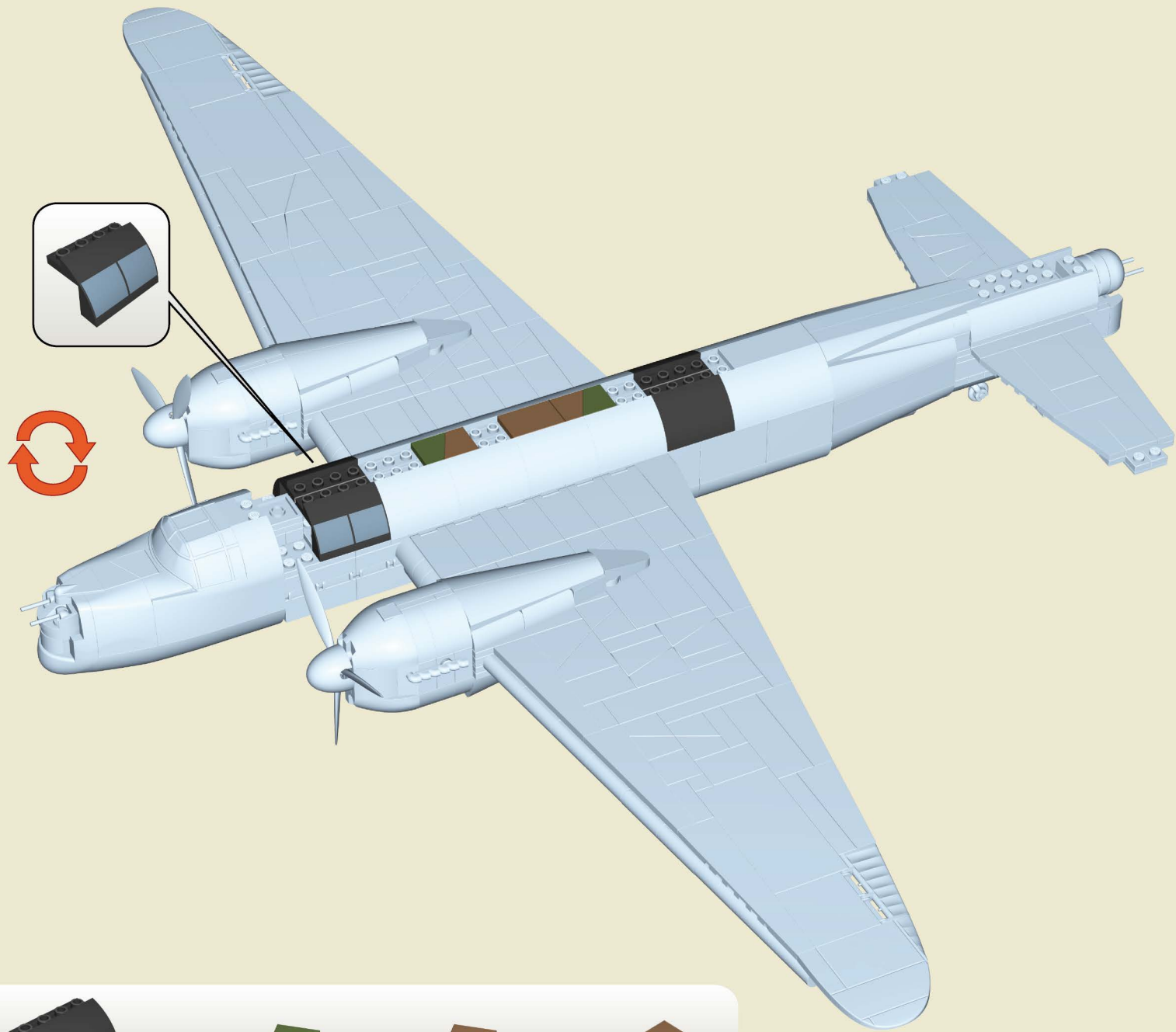

x2

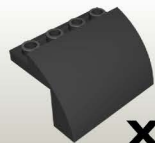

x2



x2



x2

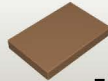

x1





x2



x1

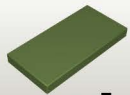

x1



x1

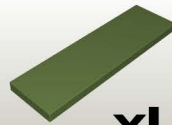

x1

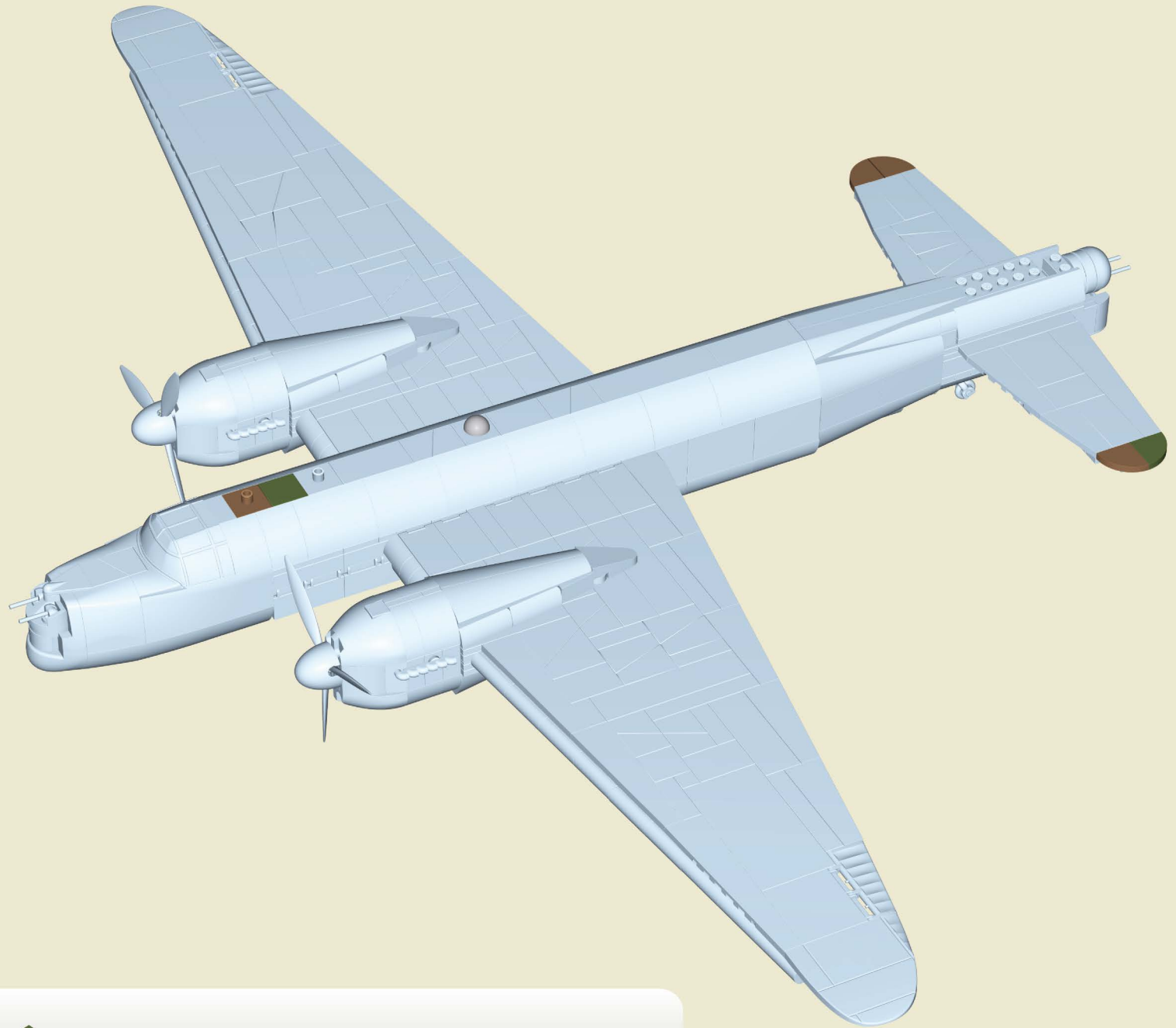

x1



x1



x1



x3



x1

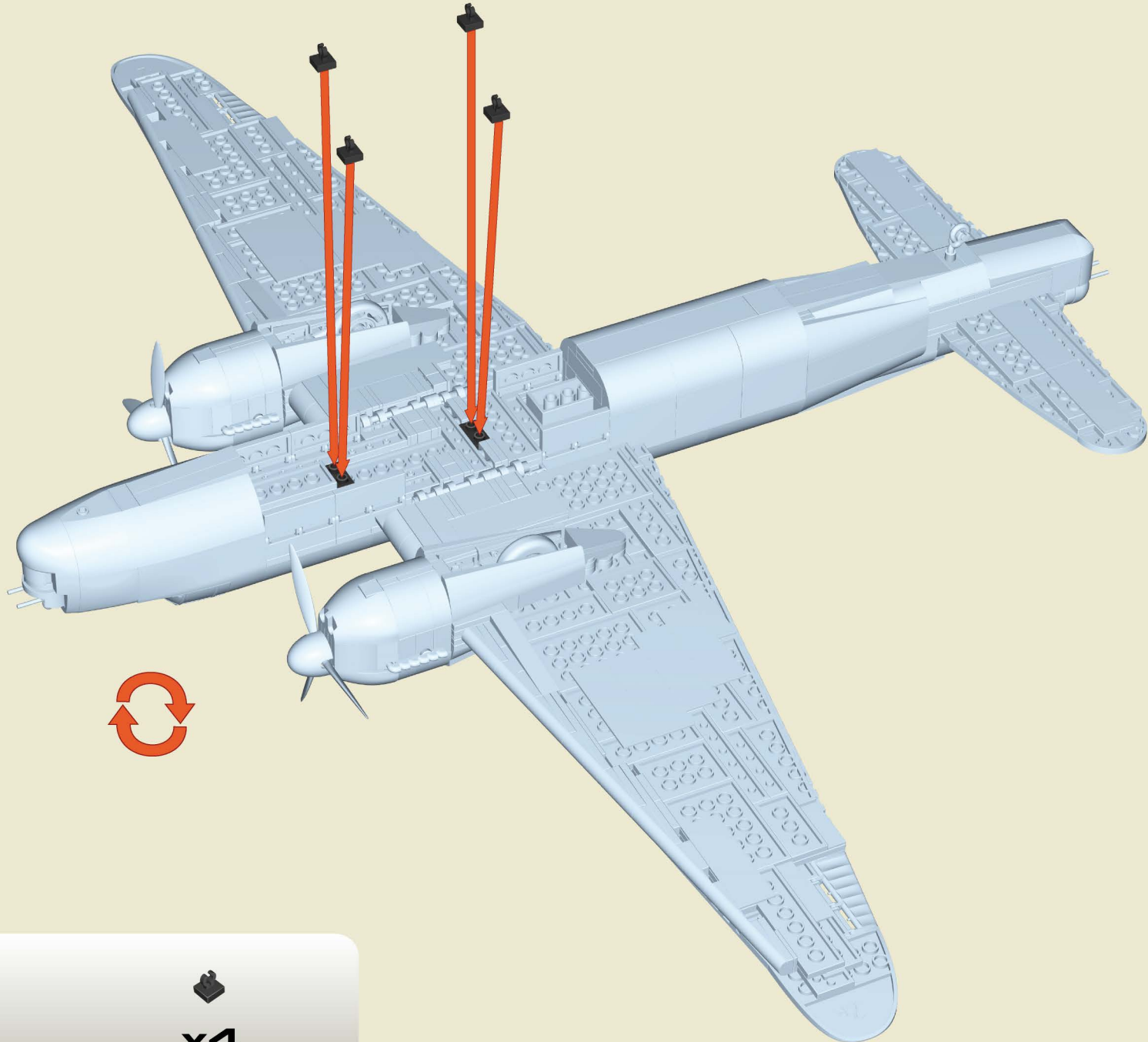

x2



x4



165

1:1

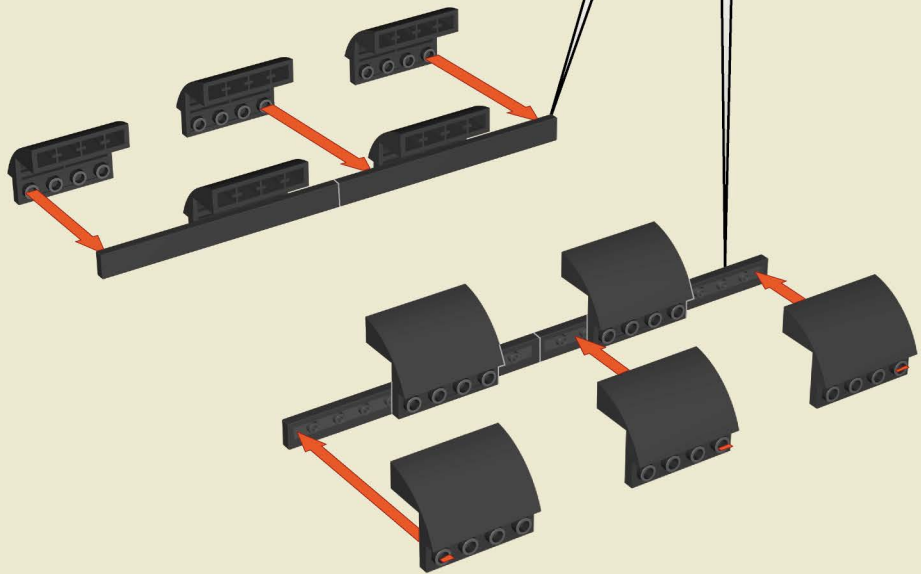

166

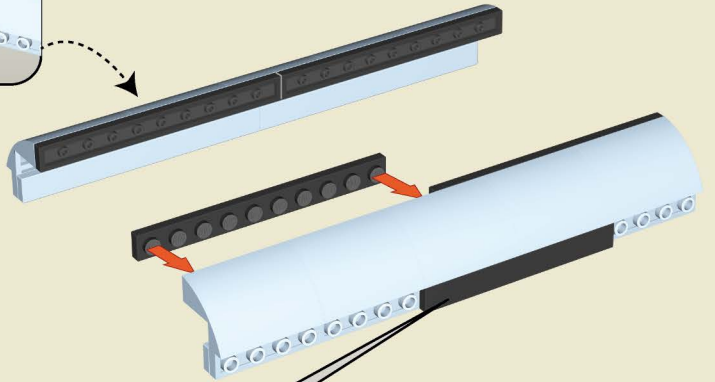
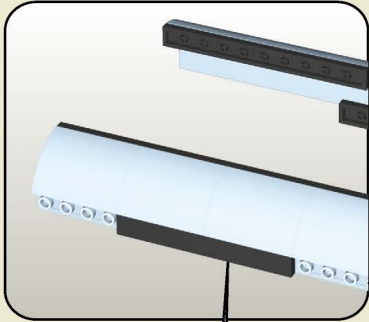

1:1

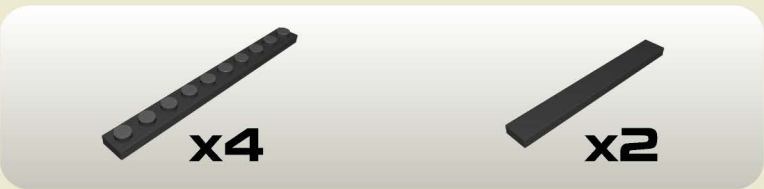

167

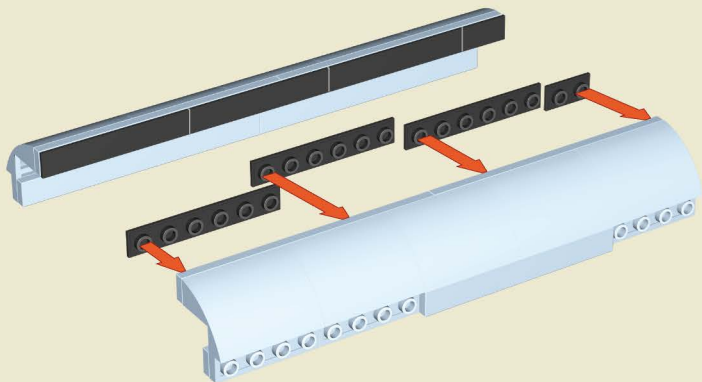

168

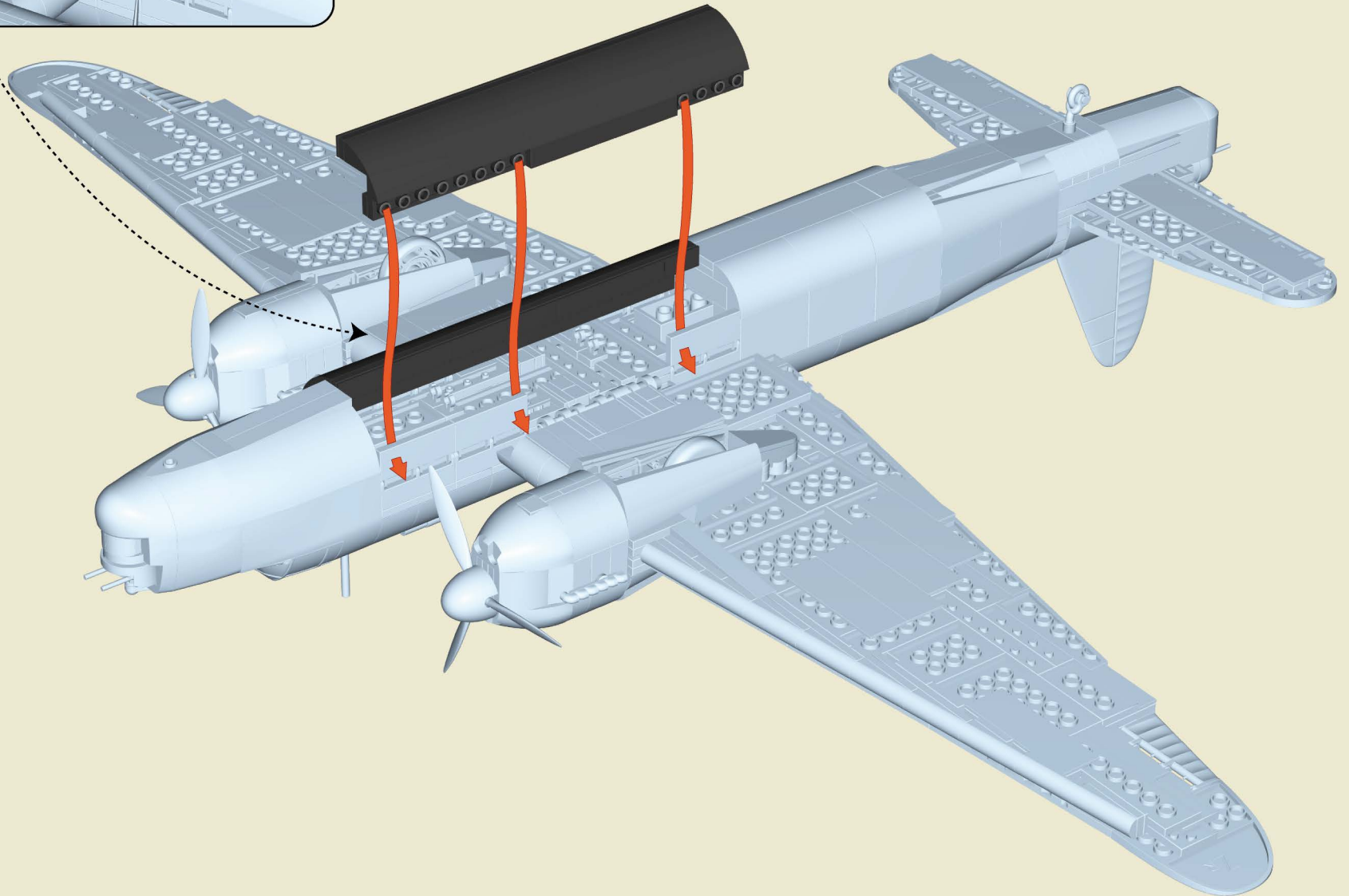
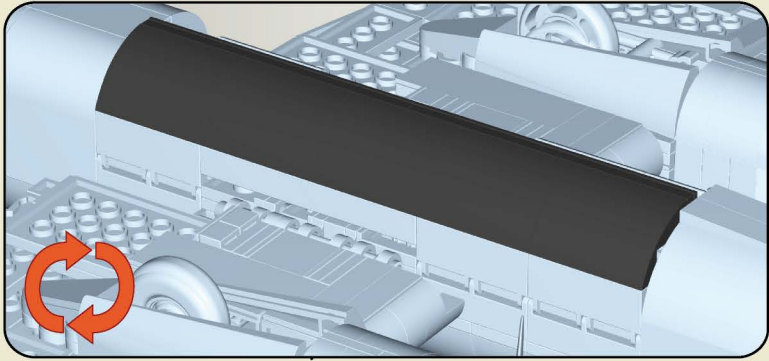

169

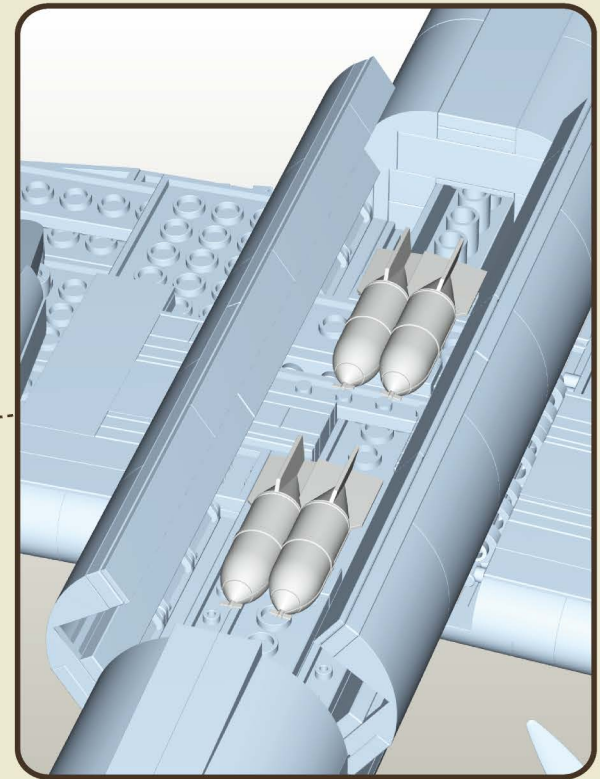
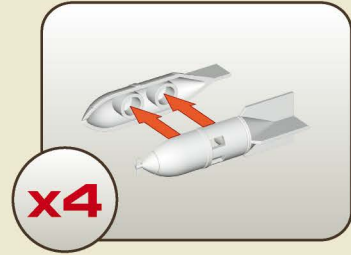
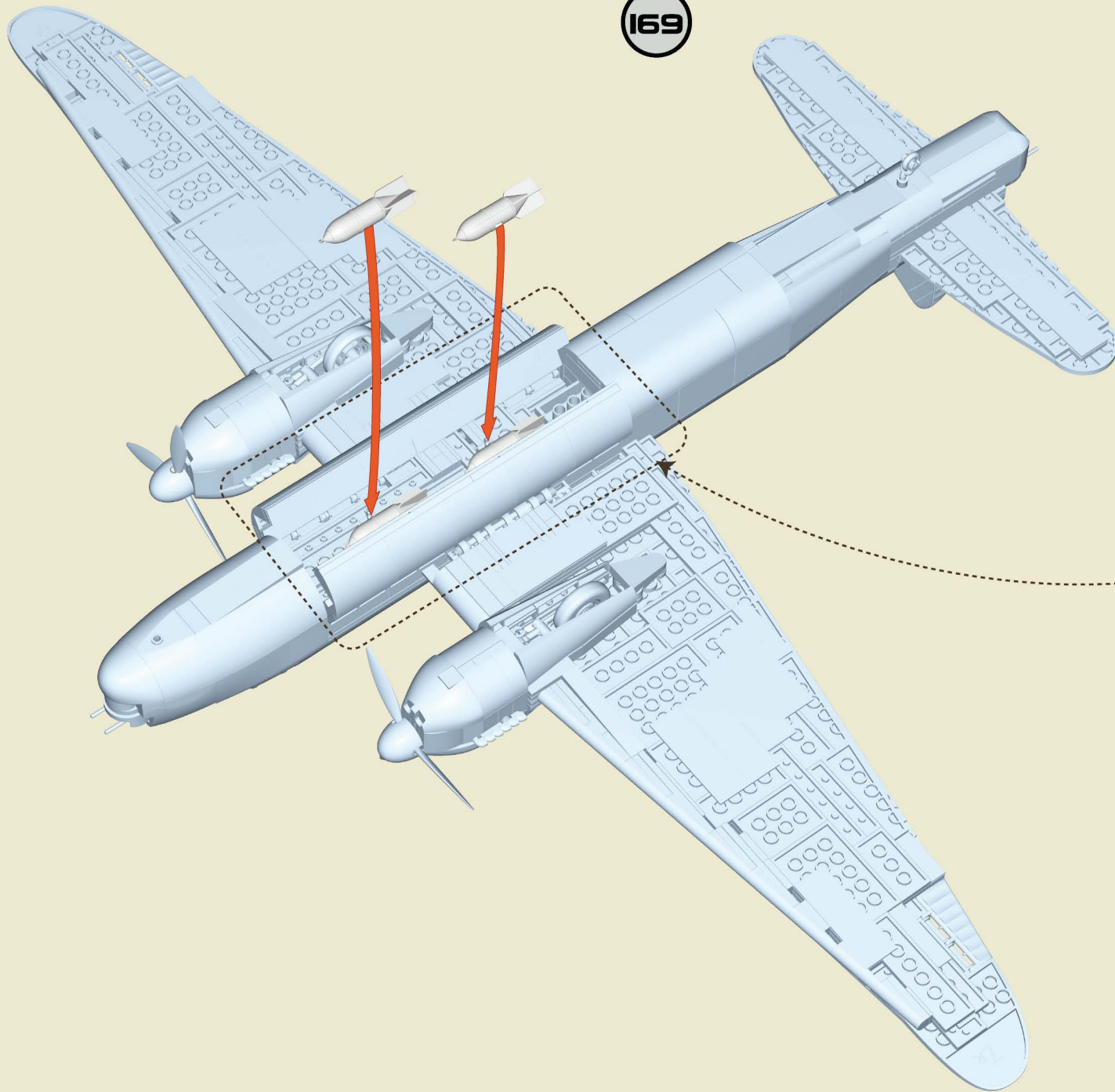



170

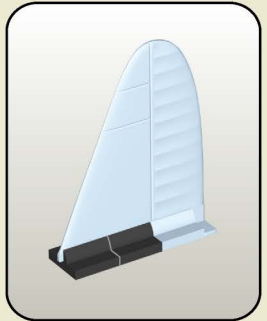
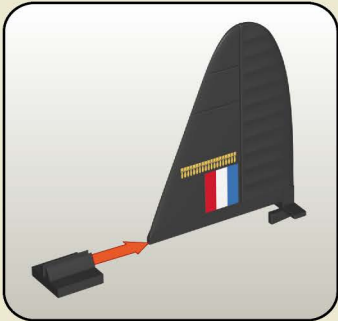
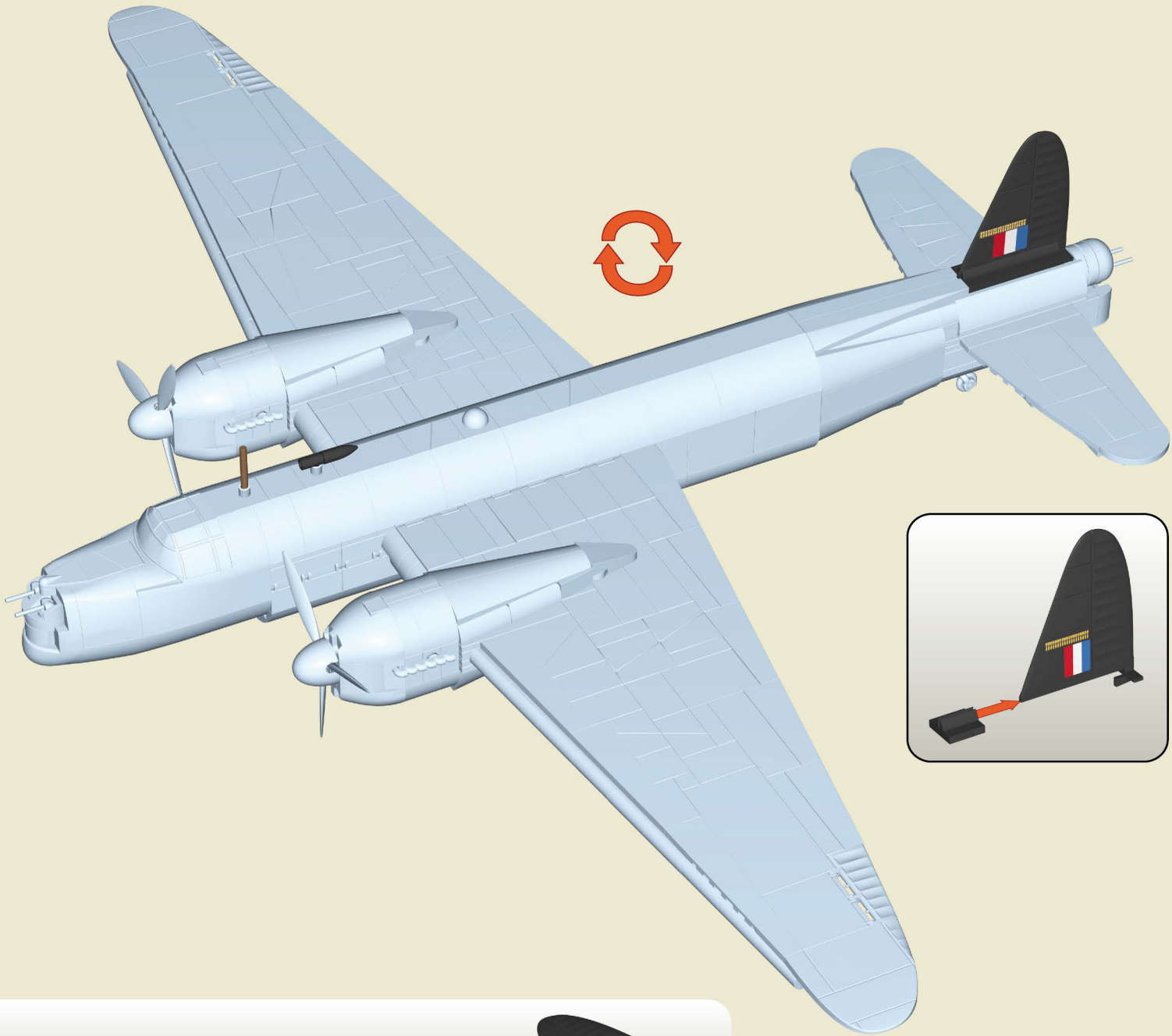
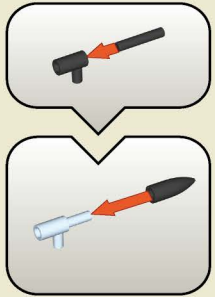

x1



x1



x1



x1



x3

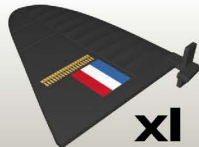

x1

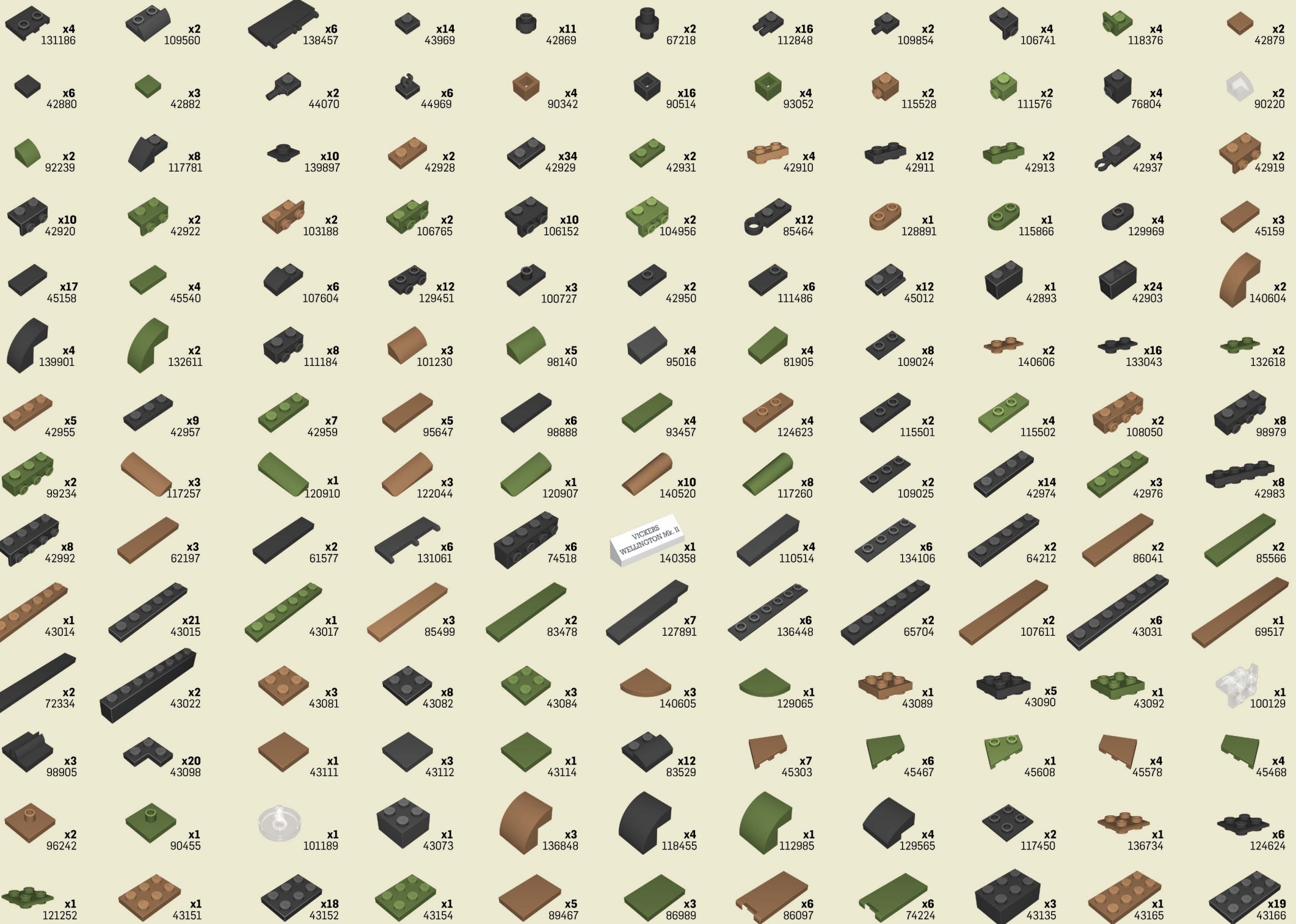









# HISTORICAL COLLECTION



MORANE-SAULNIER MS.406  
🇫🇷 5724

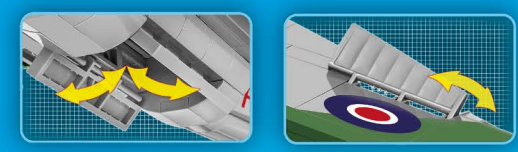

DE HAVILLAND MOSQUITO FB MK. VI  
🇬🇧 5718

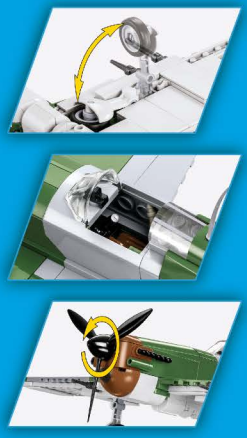

DEWOITINE D.520  
🇫🇷 5720



LOCKHEED® P-38 LIGHTNING® (H)  
★ 5726

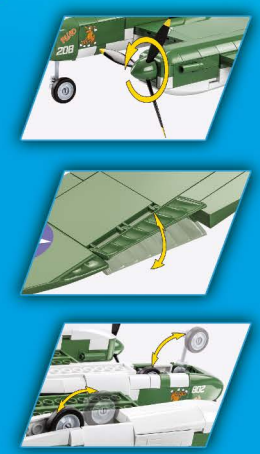

WWW.COBI.EU

00-05723-1150

For news and special deals

Find us on:  
f cobr.bricks  
cobi.klocki  
COBI SA