



SONIC™

THE HEDGEHOG

76996



LEGO® Builder



LEGO.com/sustainable-packaging



FR
DONNEZ
OU
RECYCLEZ



ASSOCIATION

OU



MAGASIN

OU



DÉCHÈTERIE

Adresses sur quefairedemesdechets.fr



BUILDER



Apple and the Apple logo are trademarks of Apple Inc., registered in the U.S. and other countries and regions. App Store is a service mark of Apple Inc. Google Play and the Google Play logo are trademarks of Google LLC. Tencent and the Tencent logo are trademarks of Tencent Inc.

LEGO.com/devicecheck

EN Ask parents' permission before going online | DE Eltern um Erlaubnis bitten, bevor du online gehst | FR Demande l'autorisation d'un parent avant d'aller en ligne | IT Chiedi il permesso ai tuoi genitori prima di andare online | ES Pídeles permiso a tus papás antes de conectarte a Internet | PT Pede autorização aos pais antes de acederes online | ZH 上网前应先征得父母的同意 | PL Poproś rodziców o zgodę, zanim wejdiesz do Internetu | CS Než půjdeš na internet, požádej rodiče o svolení | SK Skôr než pôjdeš na internet, vypýtaj si povolenie od rodičov | HU Kérj szülői engedélyt, mielőtt online csatlakoznál! | RO Cere permisiunea părinților înainte de a te conecta online | BG Поискайте разрешение от родител, преди да влезете онлайн | LV Pirms došanās tiešsaistē palūdz atļauju vecākiem | ET Enne Interneti kasutamist küsi vanematelt luba | LT Prieš prisijungdami prie interneto, atsilkauskite tėvų

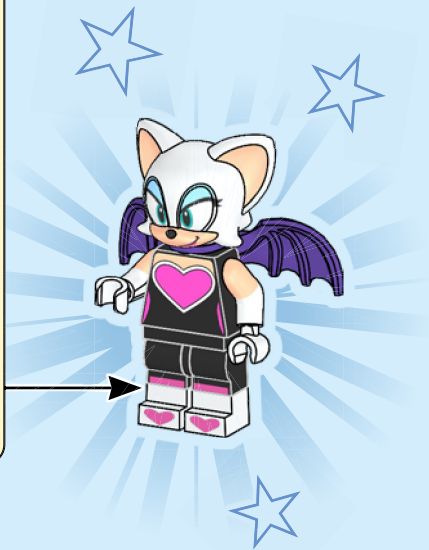
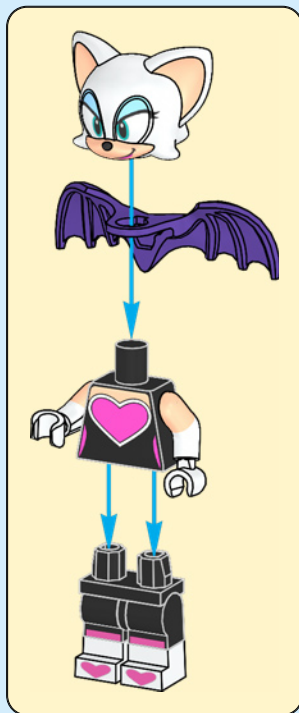

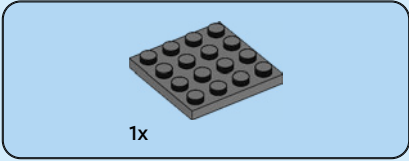
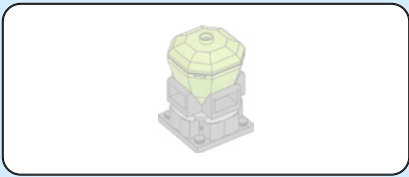

1

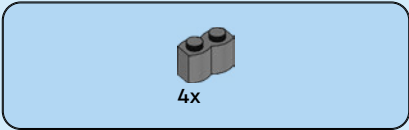
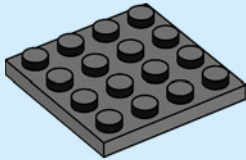

2

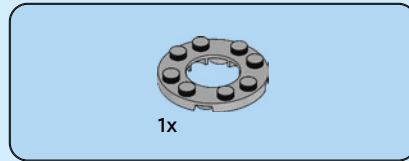
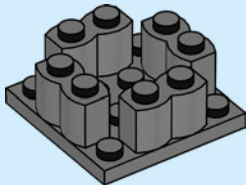

3

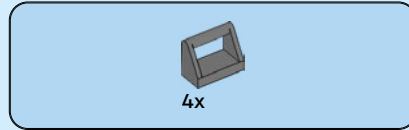
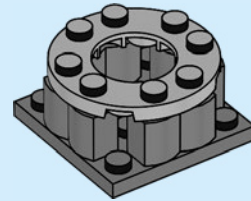

4

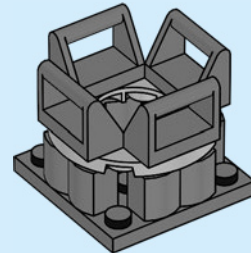

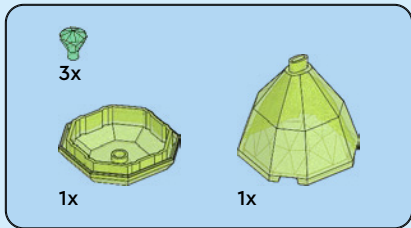

5

1

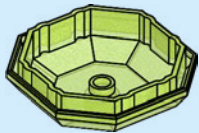

2

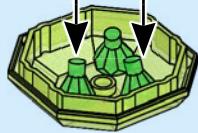

3

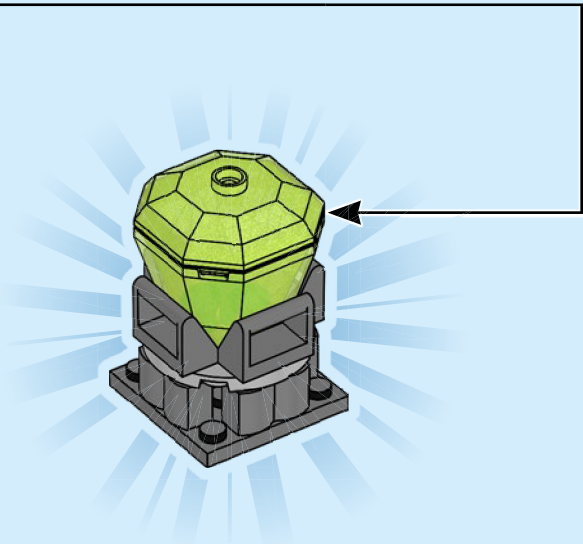
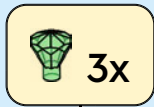

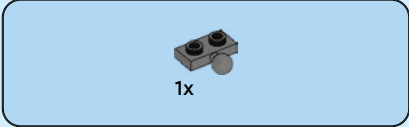
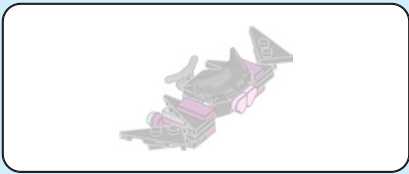

1

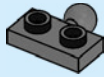

2

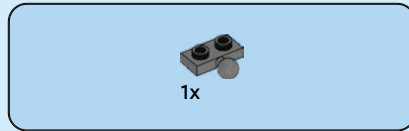
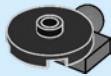

3

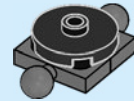

4

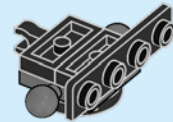
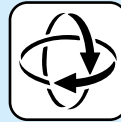



1x

5

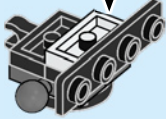

1x

6

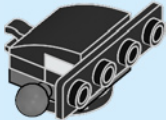

1x

7

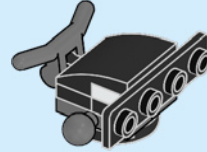

1x

8

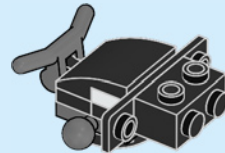



2x

9

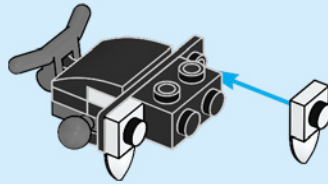

2x



2x

10

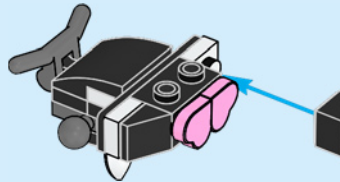

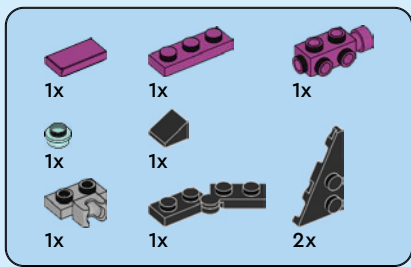

11

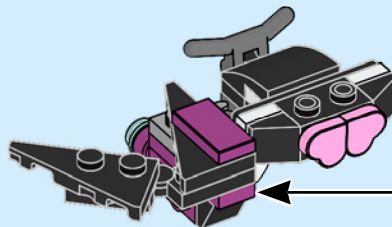
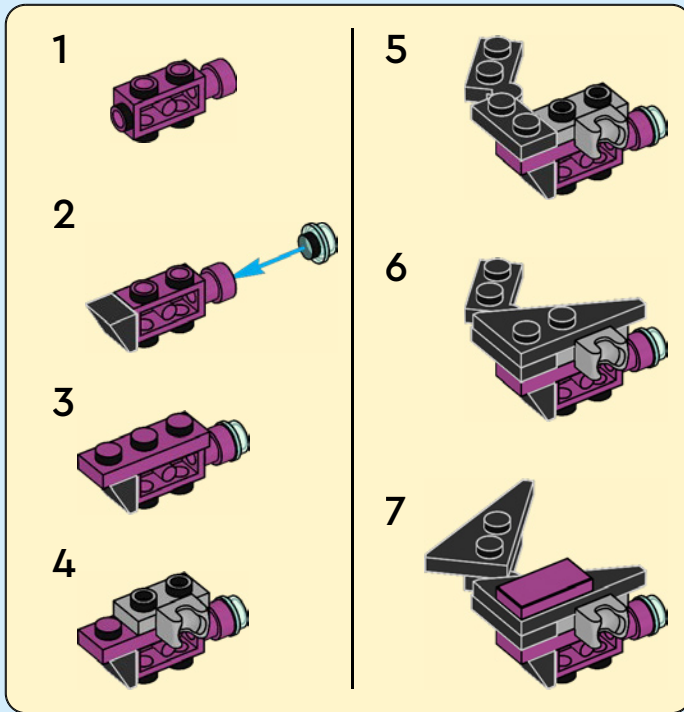

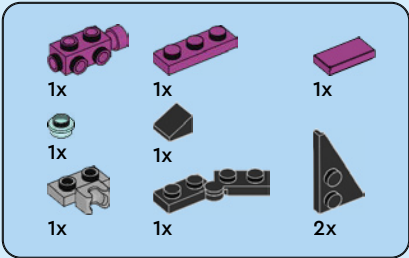

12

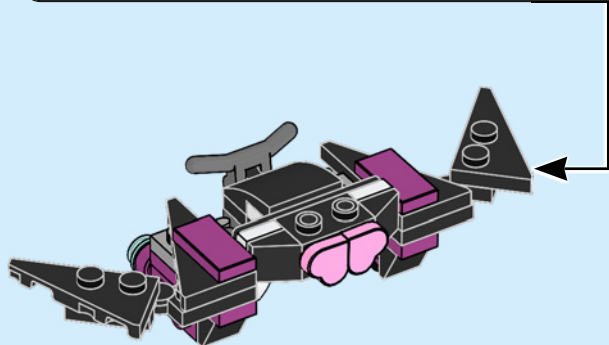
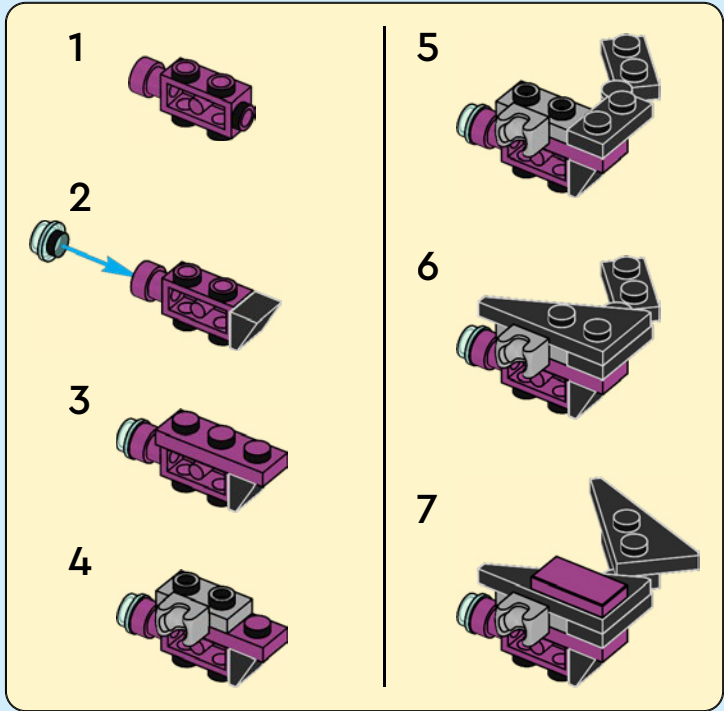

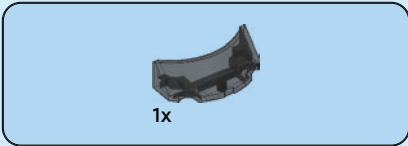

13

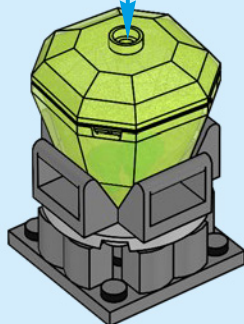

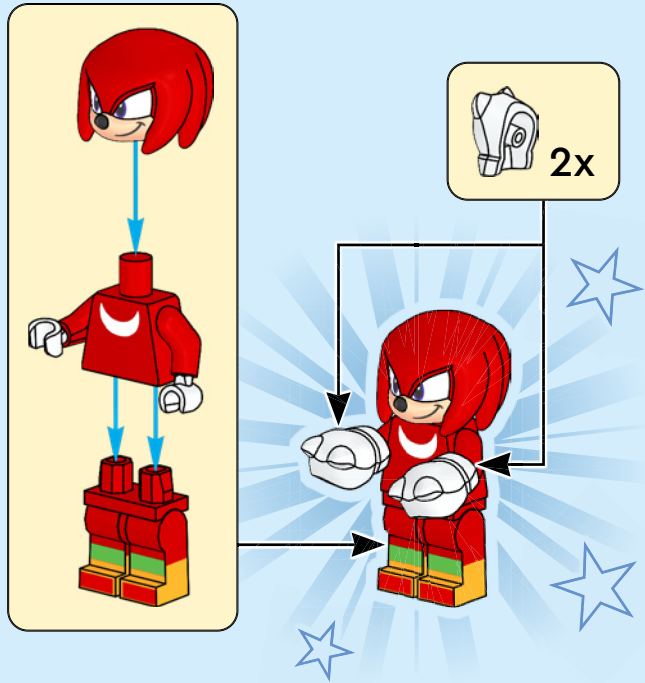

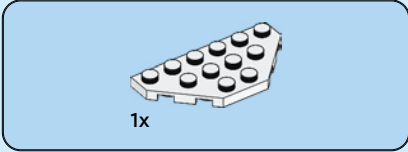
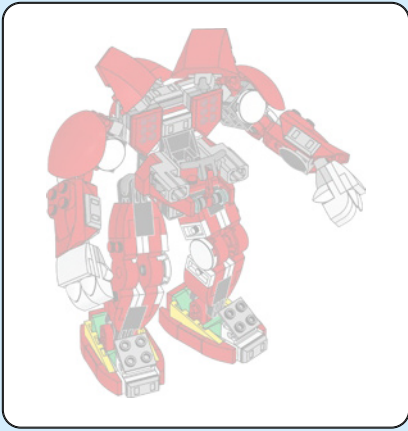

1

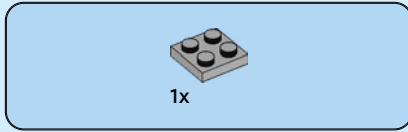

2

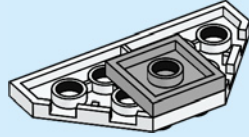

3

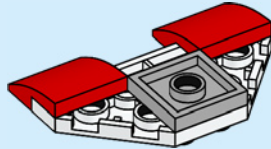

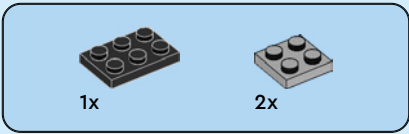

4

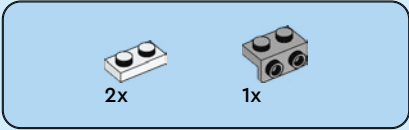
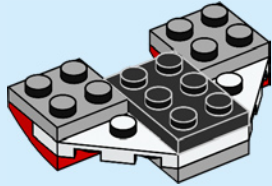

5

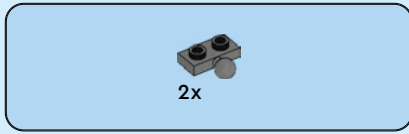
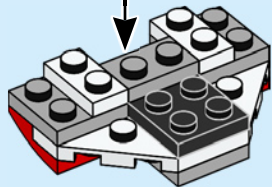
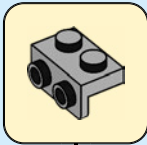

6

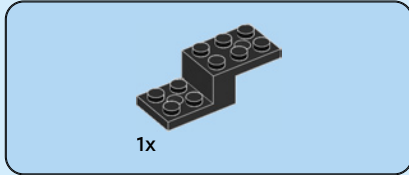
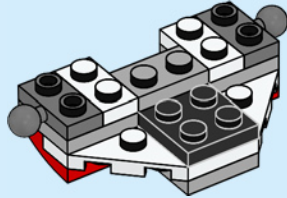

7

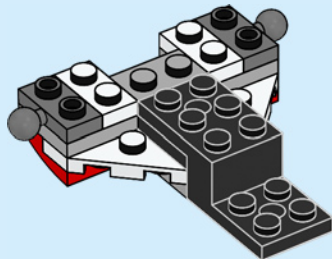



2x

8

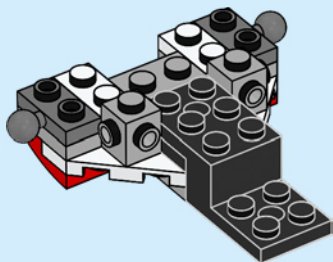

1x

9

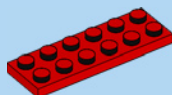
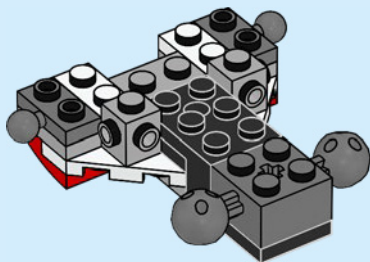

1x



2x

10

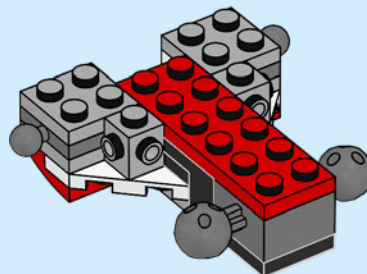



4x

11

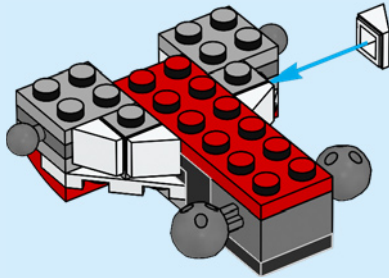

2x

12

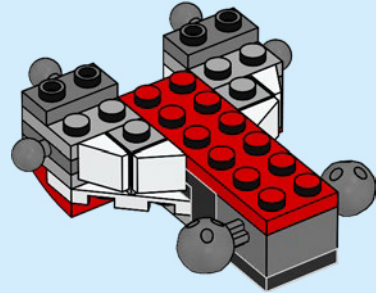

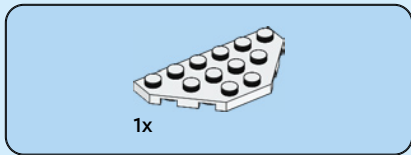

13

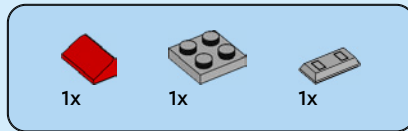
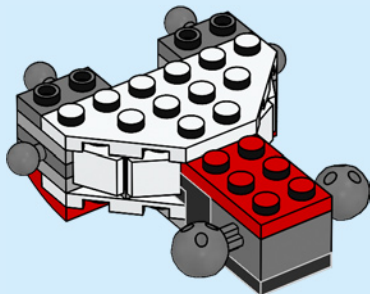

14

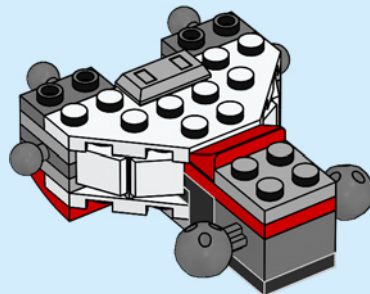



2x

15

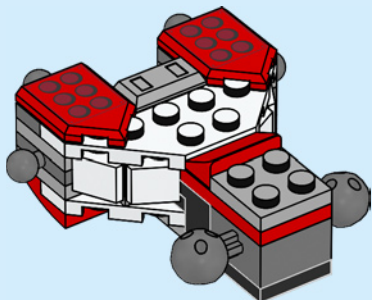

1x



1x

16

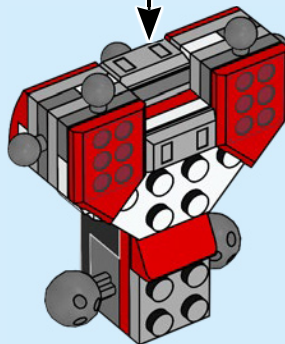
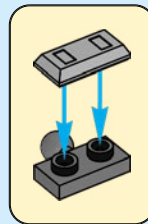

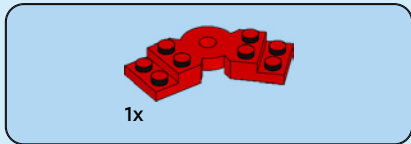
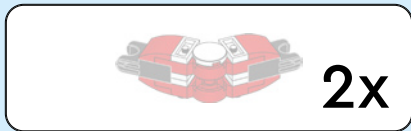

17

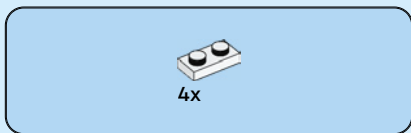
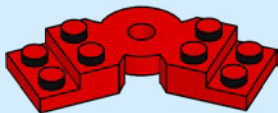

18

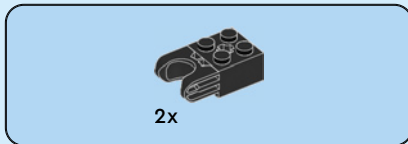
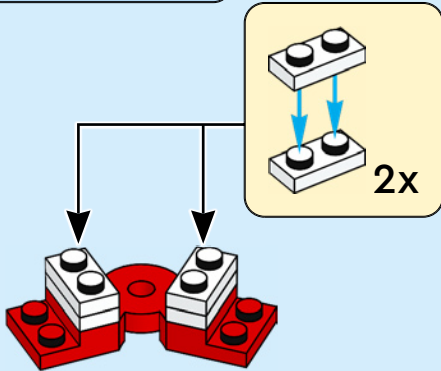

19

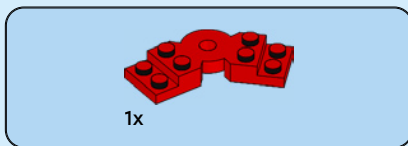

20

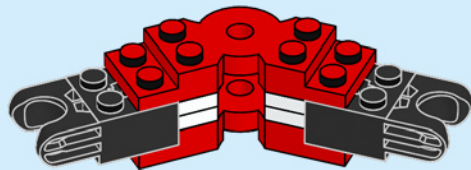



21

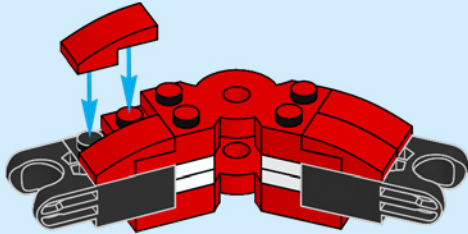

22

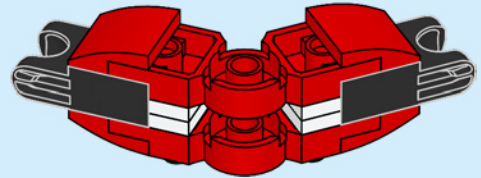
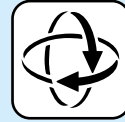



2x

23

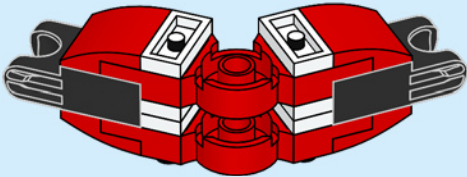

1x

24

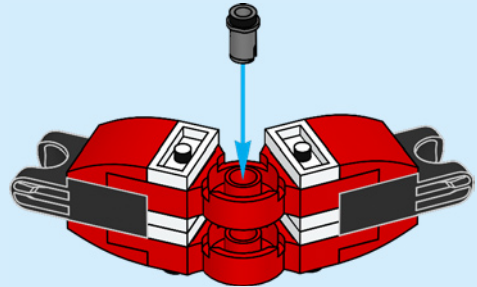



1x

25

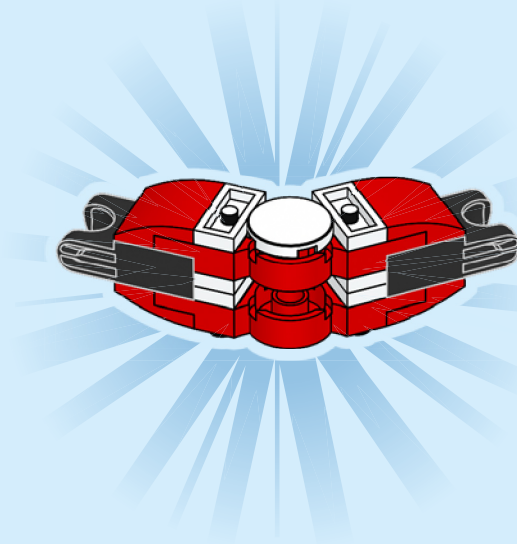

2x

26

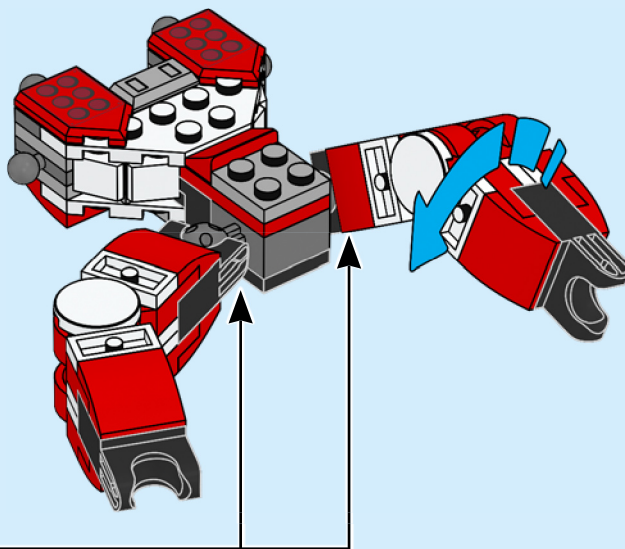



2x



1x

27



2x

28

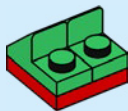

2x

29

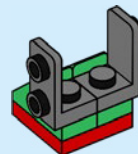

1x

30

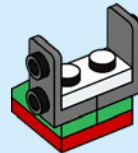

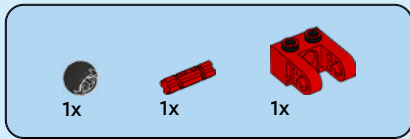

31

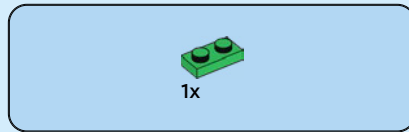
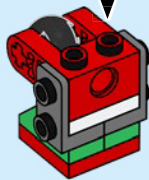
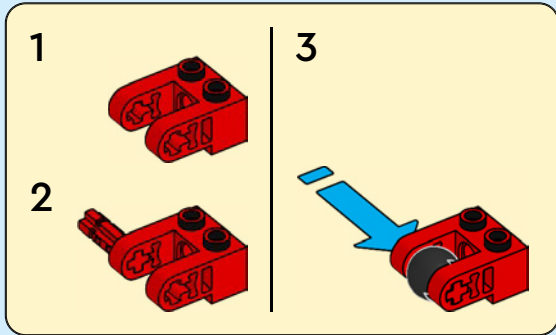

32

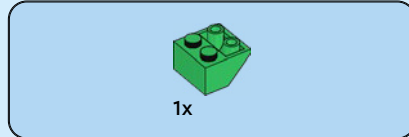
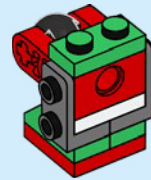

33

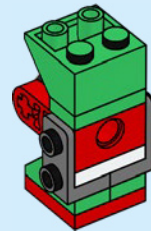



2x

34

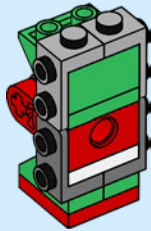

2x

35

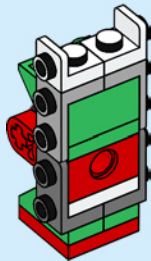

2x



1x

36

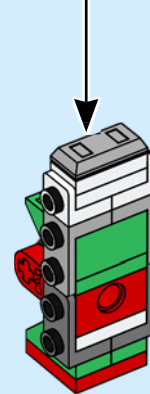
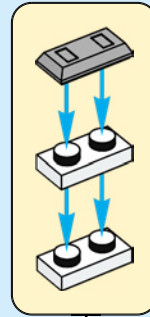

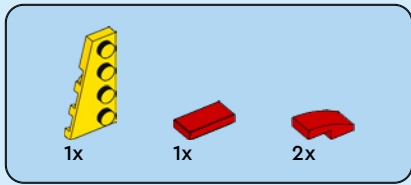

37

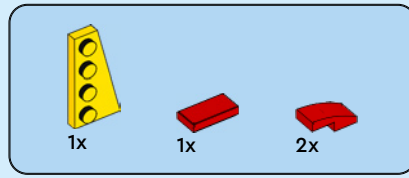
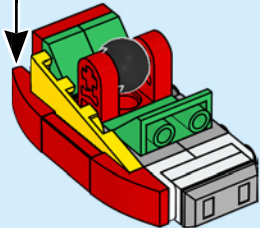
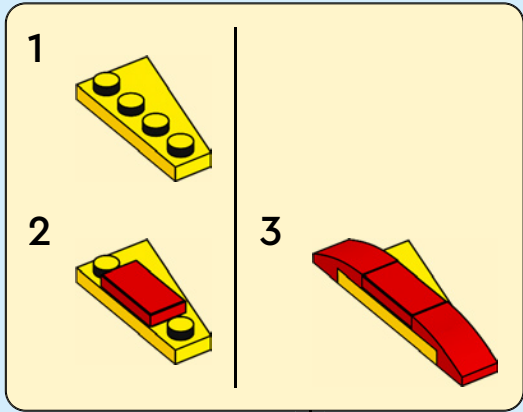

38

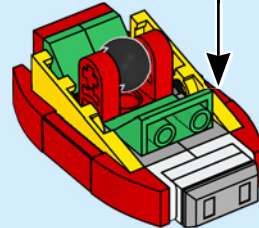
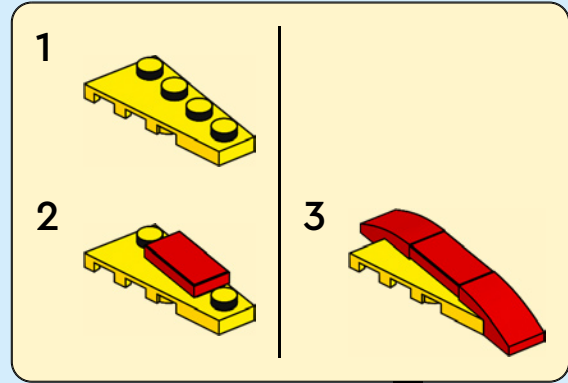



1x

39

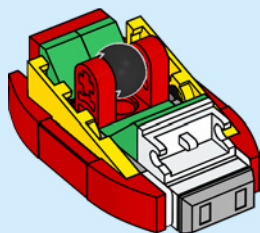

1x

40

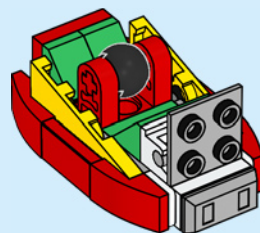

2x



41

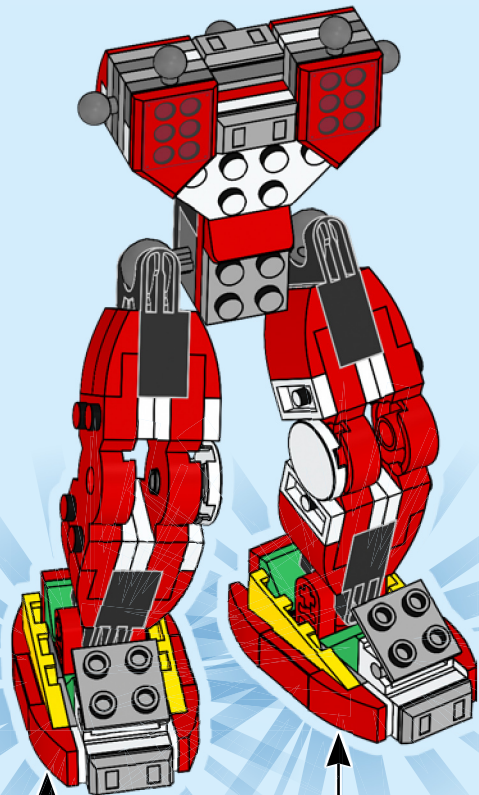



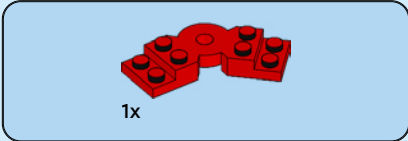
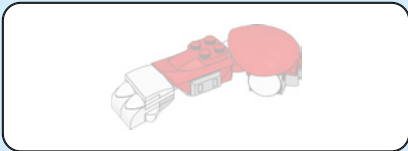

42

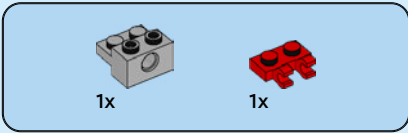

43

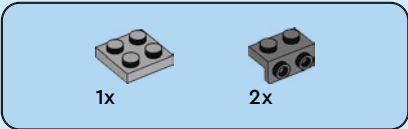
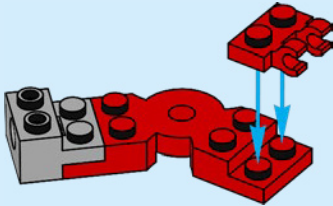

44

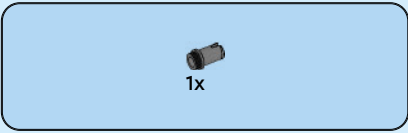
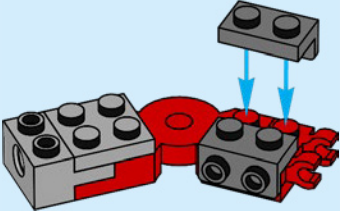

45

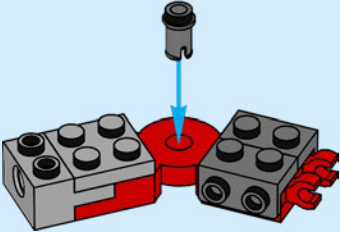

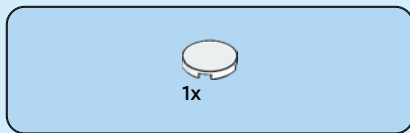

46

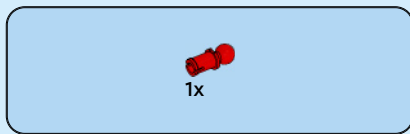

47

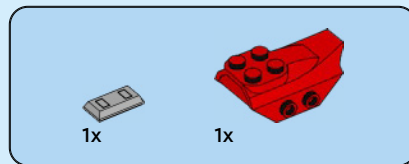
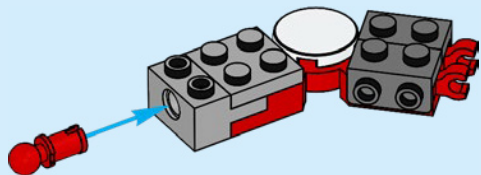

48

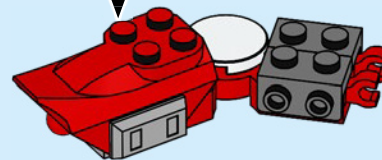
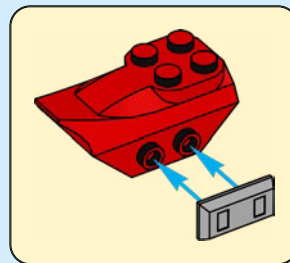

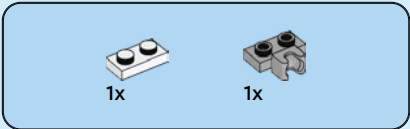

49

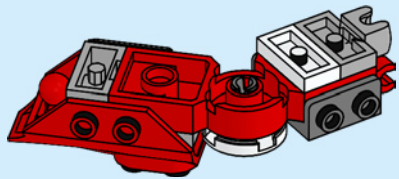

50

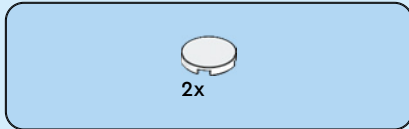
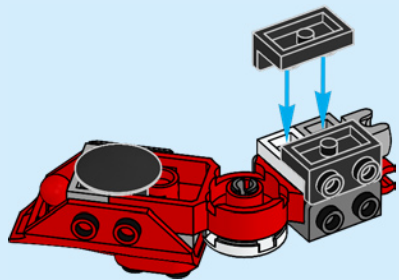

51

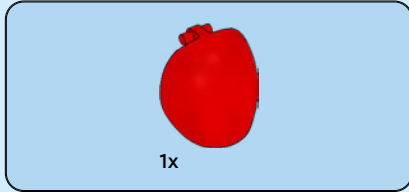
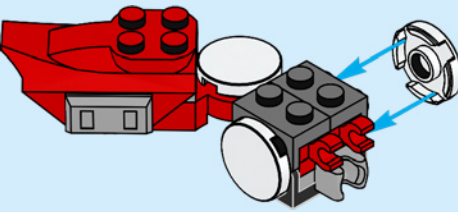

52

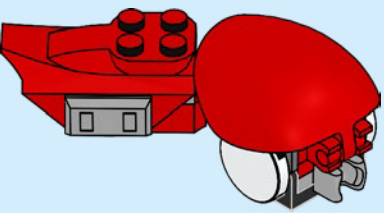

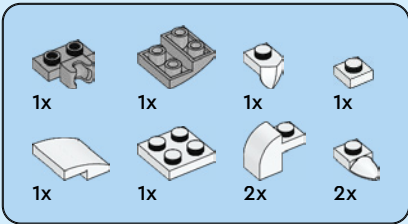

53

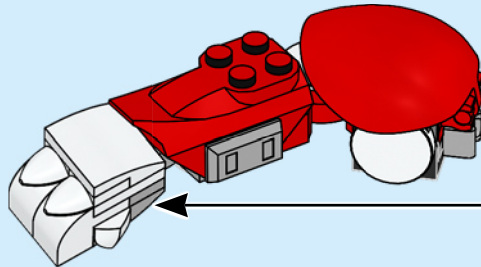
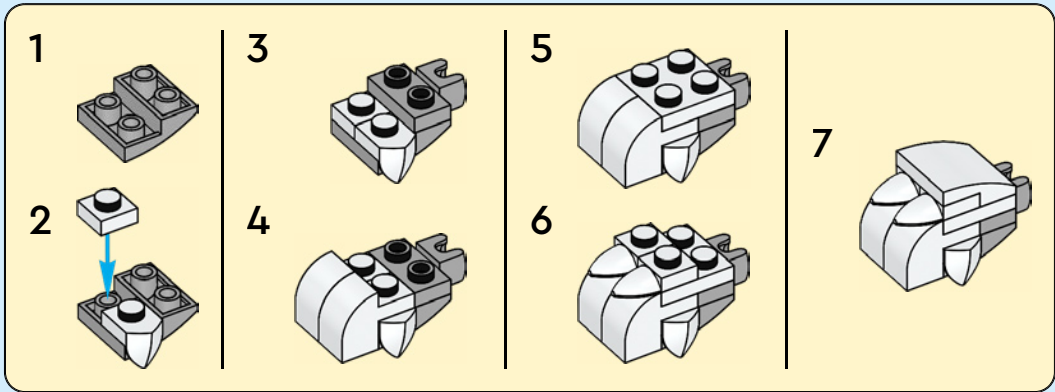

54

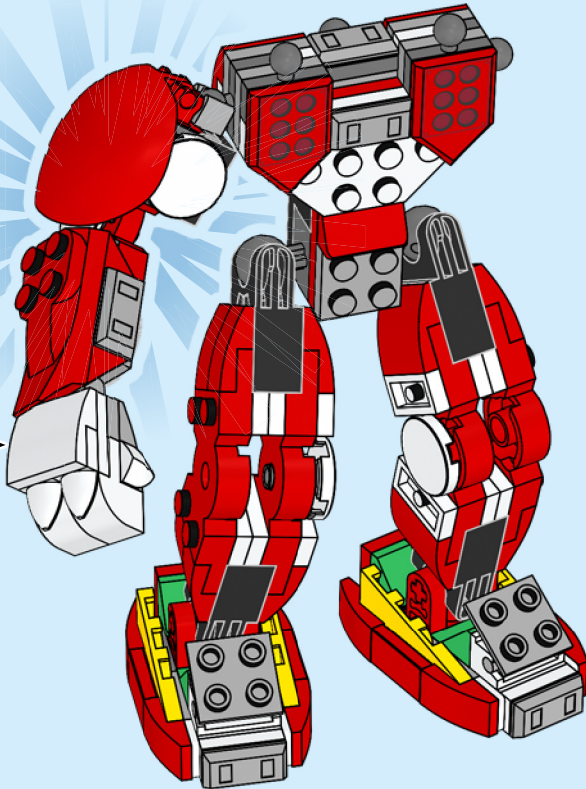

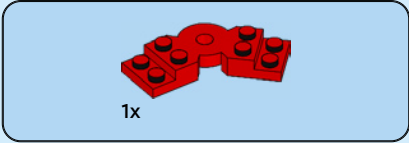
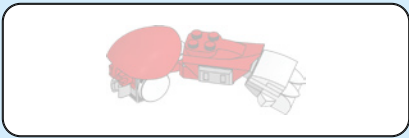

55

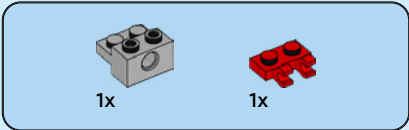
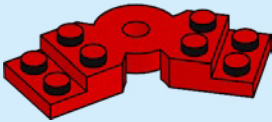

56

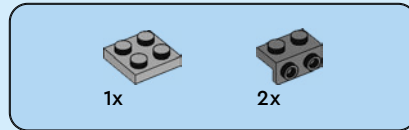
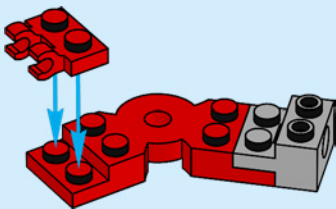

57

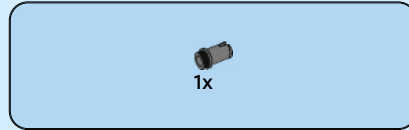
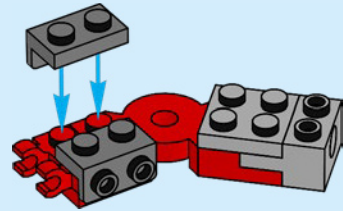

58

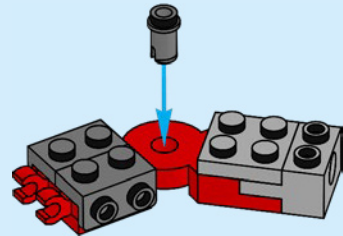

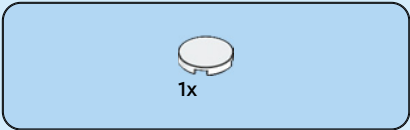

59

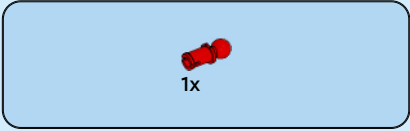
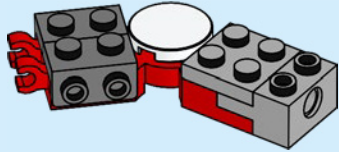

60

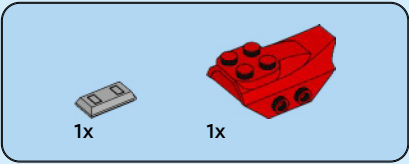
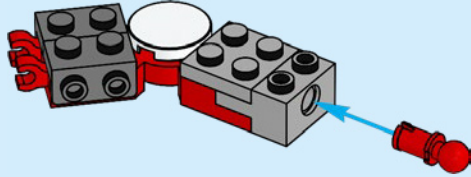

61

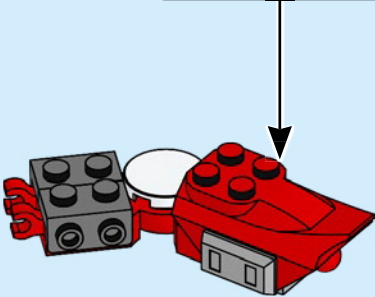
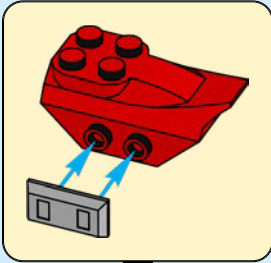



1x



1x

62

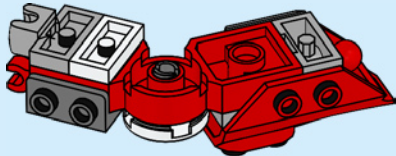

1x



2x

63

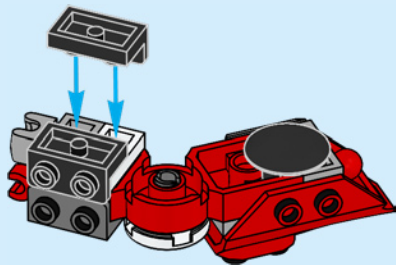

2x

64

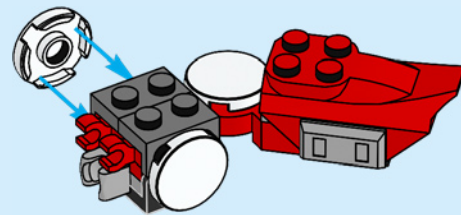
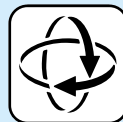

1x

65

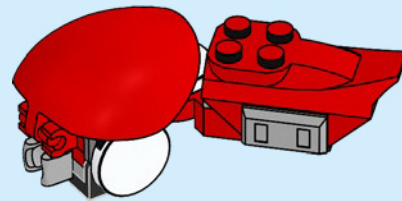

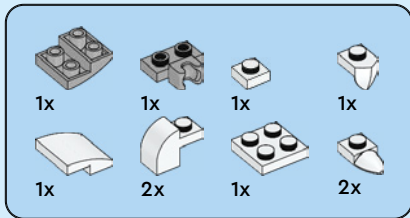

66

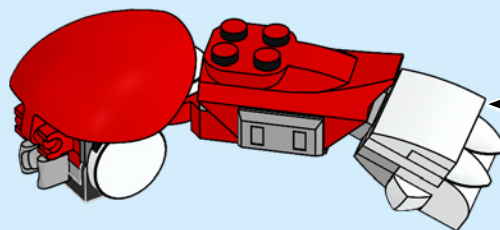
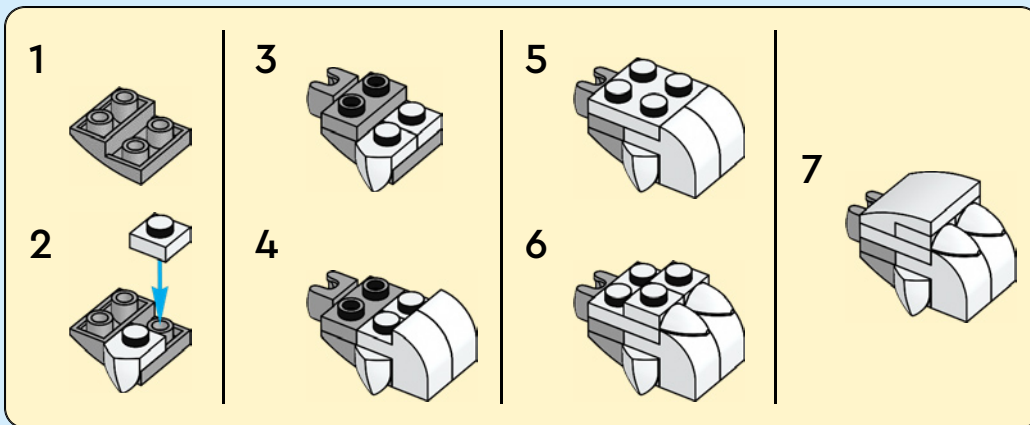

67

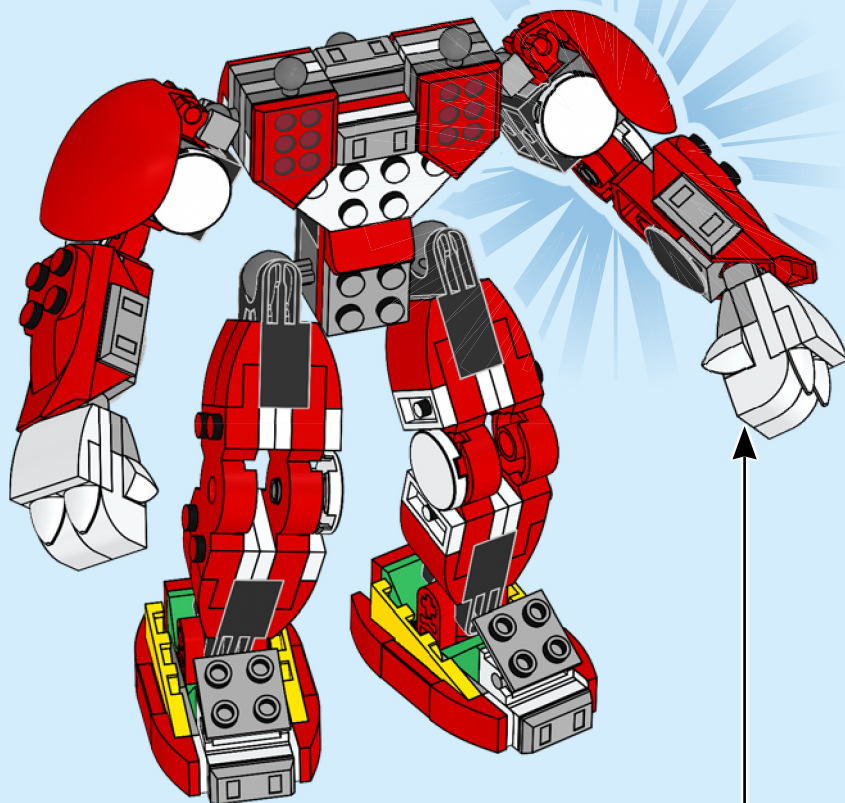

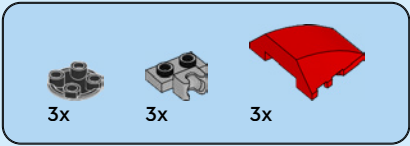

68

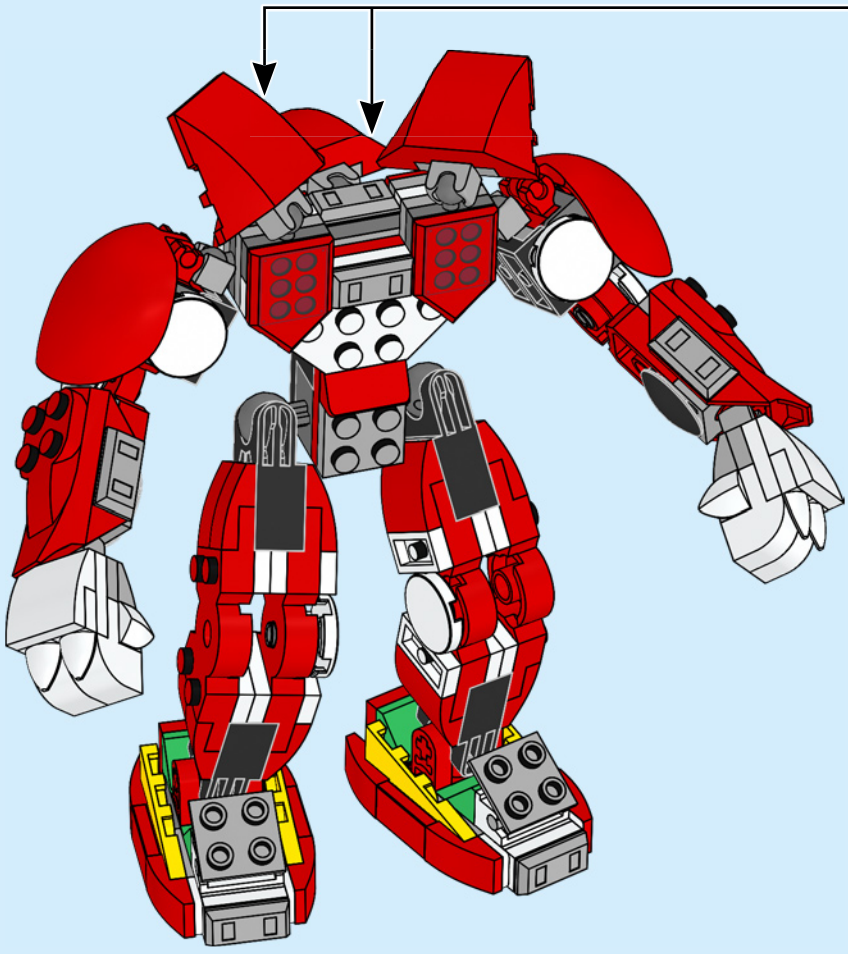
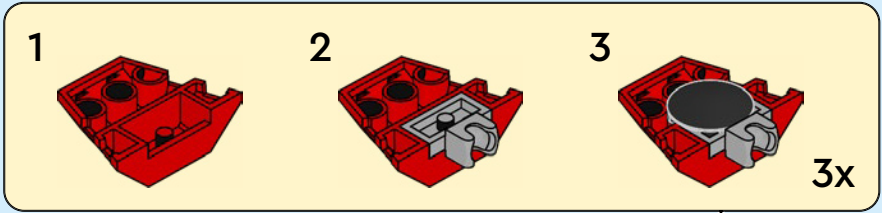

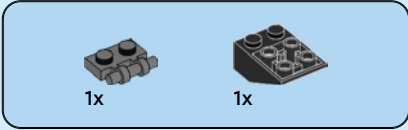
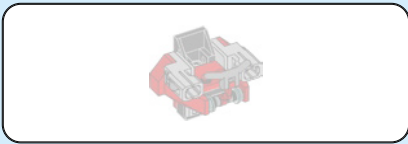

69

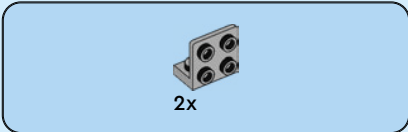
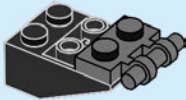

70

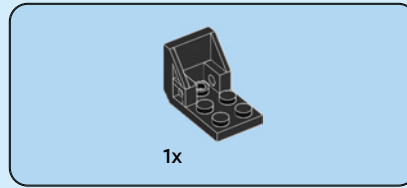
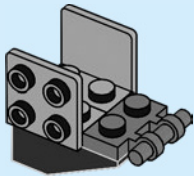

71

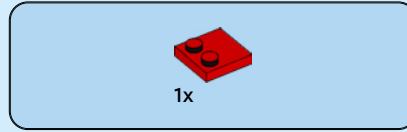
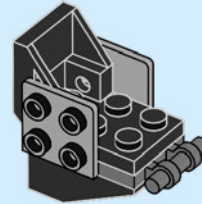

72

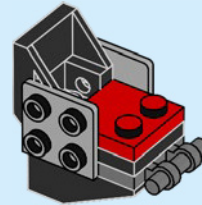

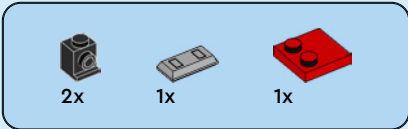

73

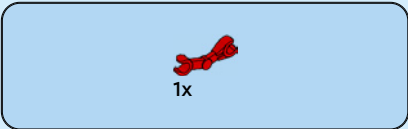
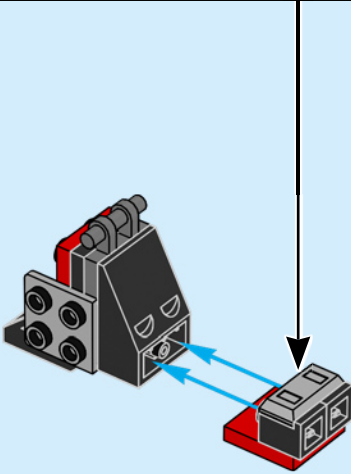
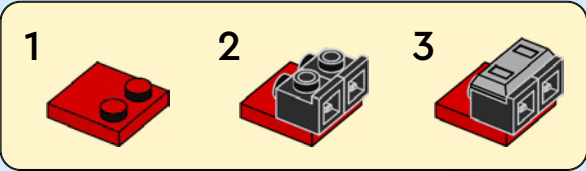

74

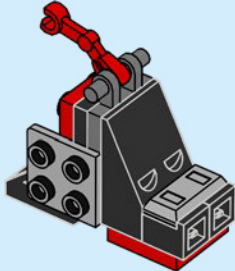



1x

75

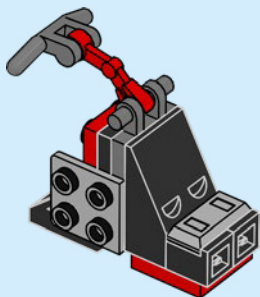

2x

76

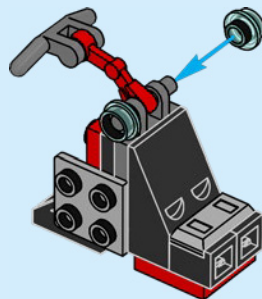

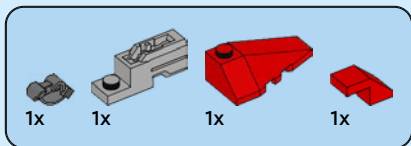

77

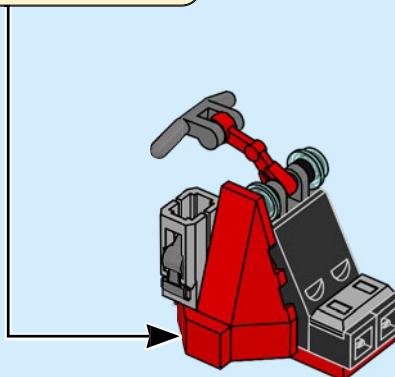
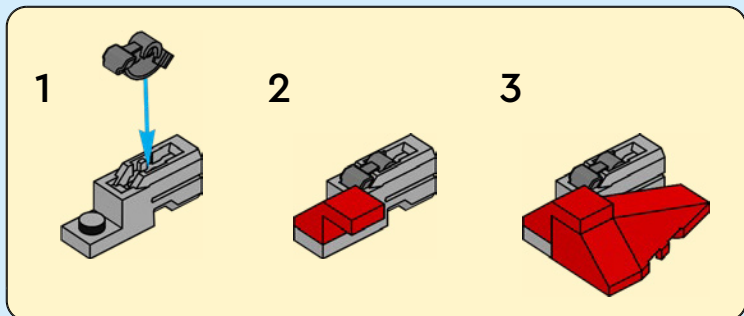

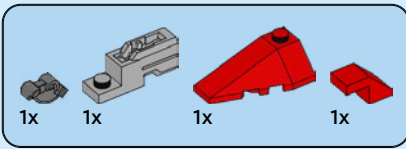

78

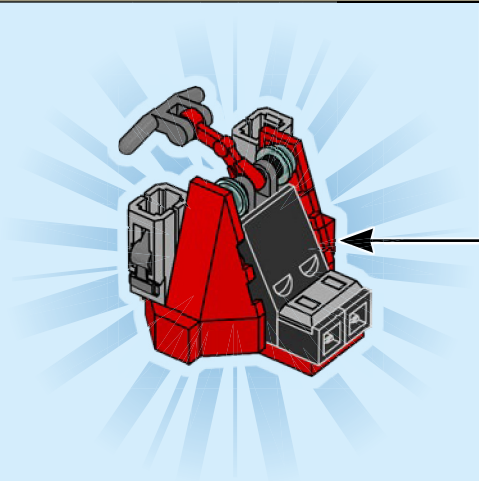
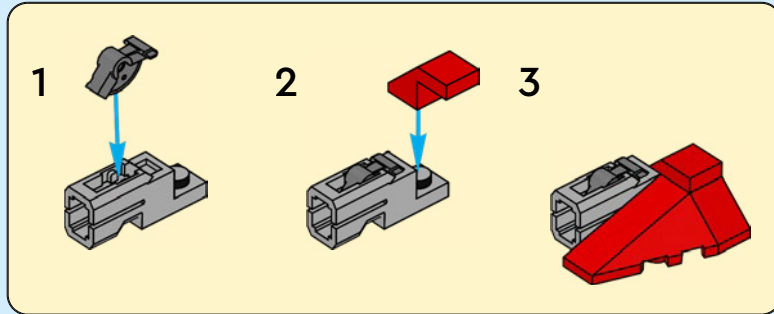

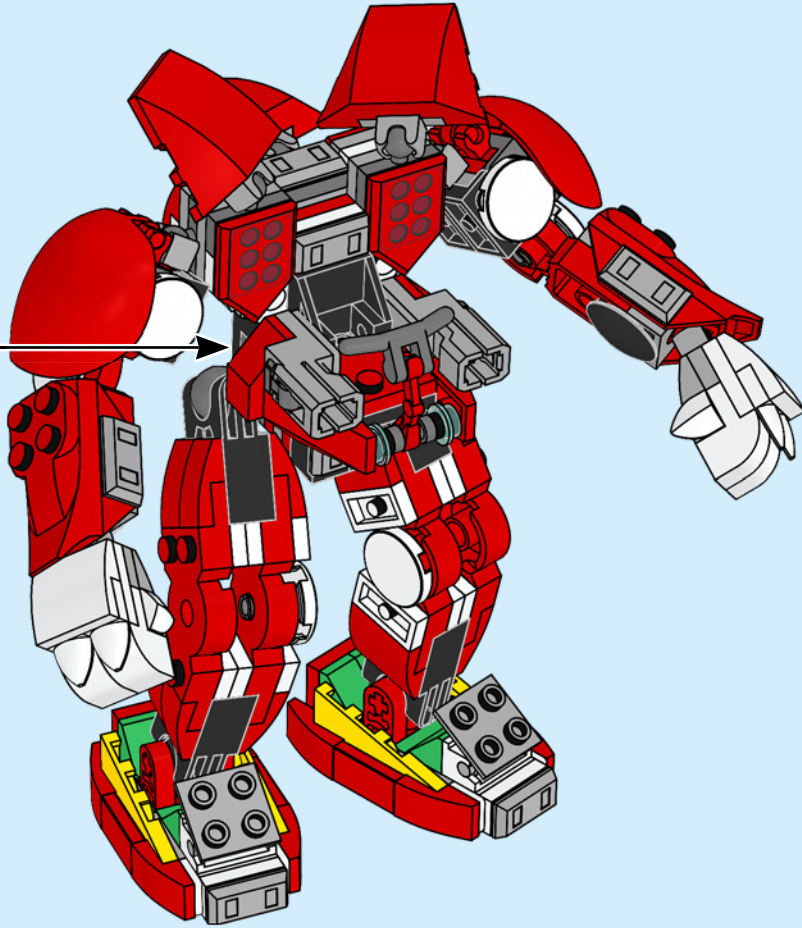



4x

80

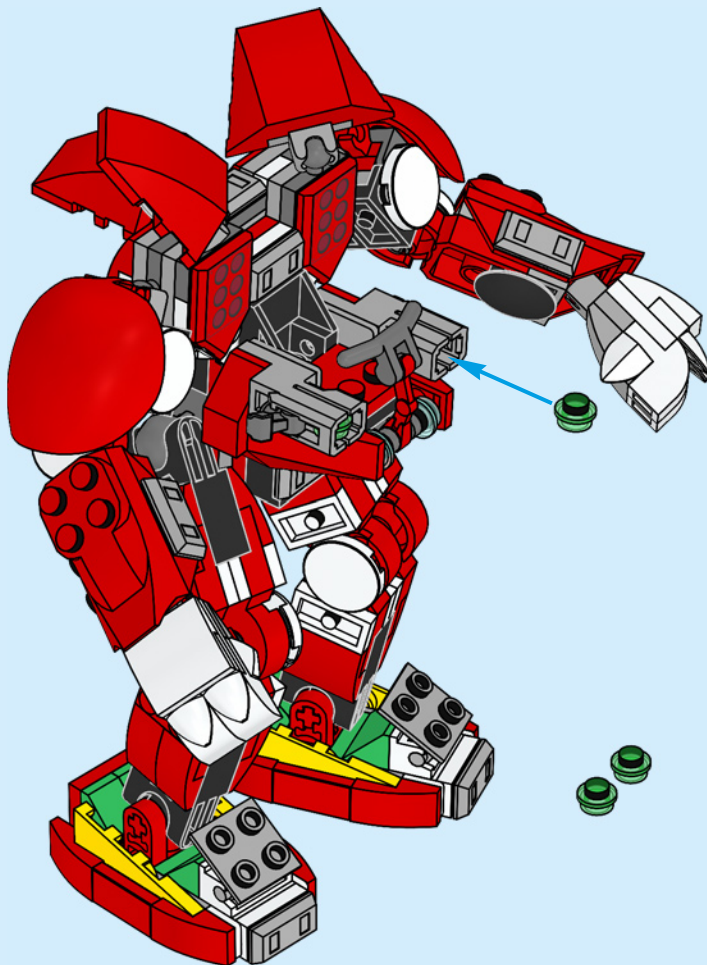

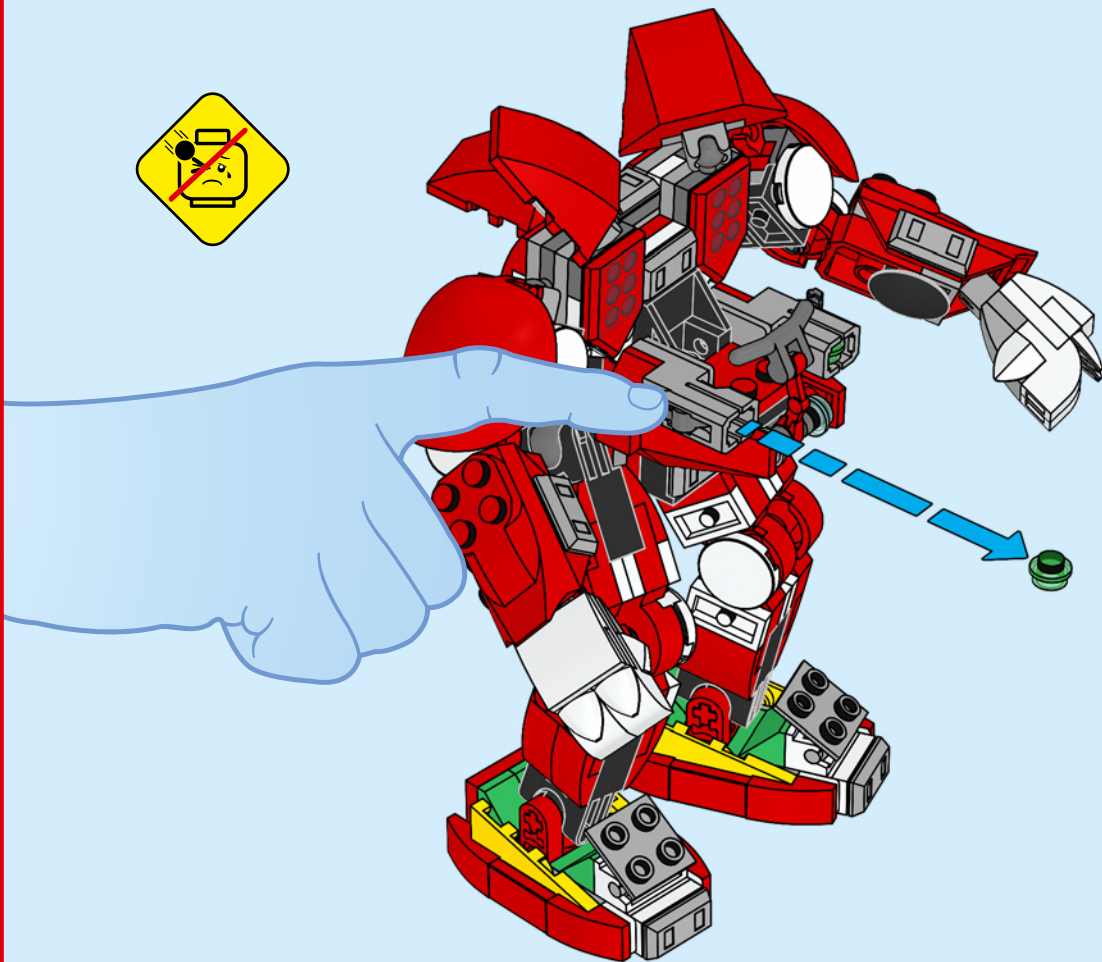

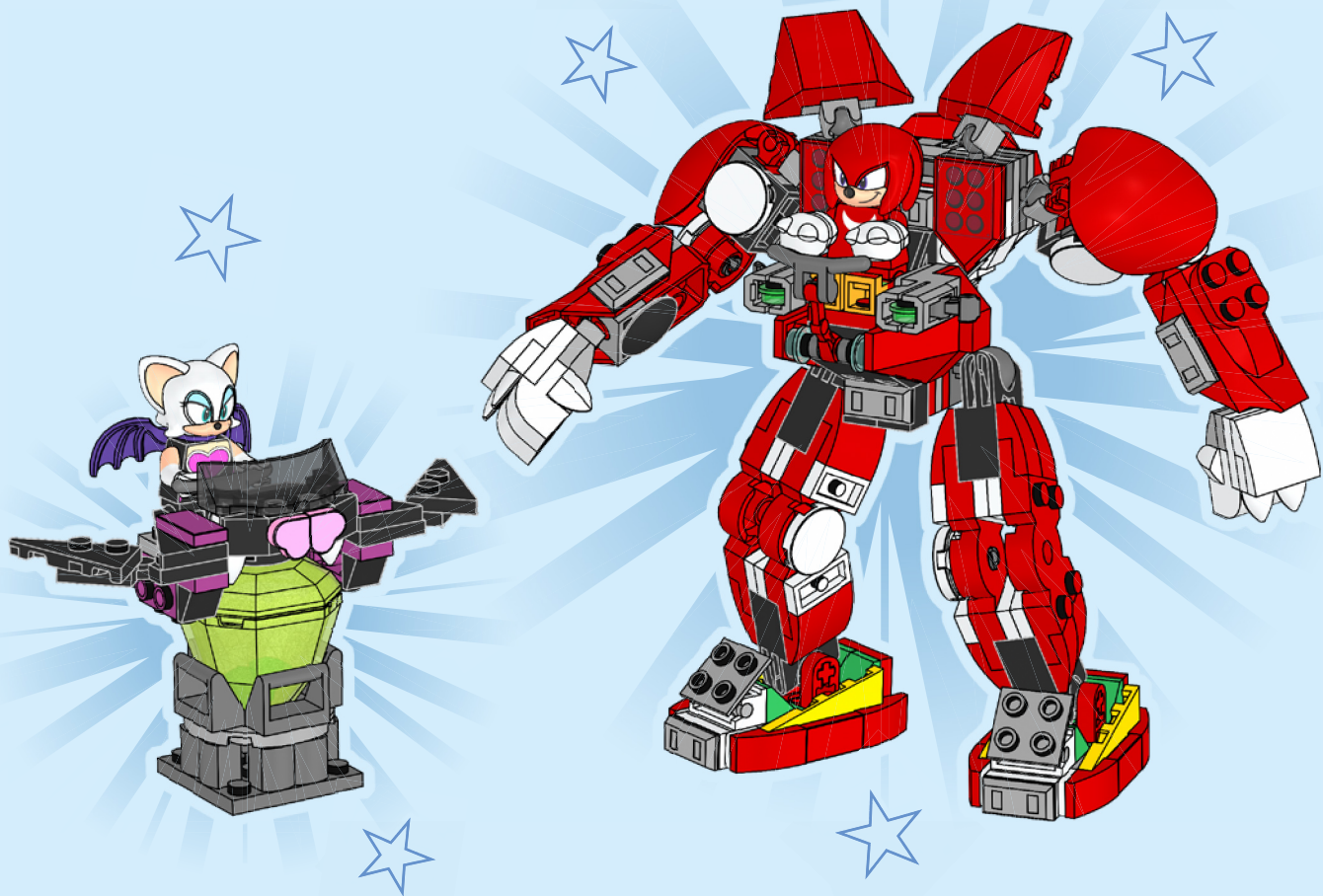



SONIC™

THE HEDGEHOG

EXPLORE MORE



Explore more
Mehr entdecken
En savoir plus
Esplora di più
Explora más
Explorar mais
了解更多
Zobacz więcej

Objev více
Objav viac
Tudj meg többet!
Descoperă mai multe
Разгледайте още
Izpēti vairāk
Uuri lähemalt
Atraskite daugiau

[LEGO.com/sonic](https://www.lego.com/sonic)





76990



76991



76992



76993



76994



Rebuild
the
world™



2x
6431337

4x
4504369

2x
302401

2x
6046905

4x
6242241

6x
4224792

8x
6044691

23x
302301

2x
393701

4x
6285777

2x
302201

2x
6047220

2x
241901

2x
6360104

1x
4651524

2x
4142865

1x
6474314

2x
6275178

16x
6029946

4x
306921

1x
6370686

2x
6360036

1x
6474313

6x
6442314

2x
6219819

2x
302221

2x
6474306

1x
6474530

2x
6371957

2x
6391203

1x
6431123

3x
6215396



1x
6431121

2x
6371695

1x
379521

6x
6375427

2x
4161331

2x
4160868

2x
4286267

4x
4504382

2x
407026

2x
6295295

2x
6295293

5x
4278359

1x
6195325

1x
6474309

1x
6138173

1x
6313116

4x
6020193

1x
6211476

1x
6039194

1x
6435928

1x
6168620

1x
6021678



1x
302126

4x
6360825

2x
6416444

4x
6226931

2x
302328

2x
4142717

2x
4611415

2x
6322832

2x
6022048

2x
6240225

2x
6283590

2x
6267495

4x
6362975

9x
6043656

7x
6134378

2x
4654580

1x
4654582

8x
4211397

2x
6326478

2x
6185676

2x
4211881

2x
6360382

1x
6167798

4x
6240221

3x
6247788

4x
6336390

4x
4211095

4x
4211039

7x
6039479

4x
6214341

2x
4261908

1x
4210660

1x
6065816

1x
4243831

4x
6395635

2x
6360675

1x
6469306



1x
6376546

1x
6376539

1x
6445335

2x
6275466



1x
6480282

1x
6480128

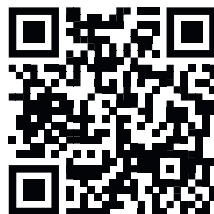

 [LEGO.com/service](https://www.LEGO.com/service)

YOU COULD **WIN**



Scan this QR code or go to **LEGO.COM/PRODUCTFEEDBACK** and give us your short feedback about this LEGO® set for a chance to win a cool LEGO prize.

Terms and Conditions apply*

EN: YOU COULD WIN. Terms and Conditions apply* **DE: Du könntest GEWINNEN.** Es gelten die Teilnahmebedingungen* **FR: Tu pourrais GAGNER.** Des conditions s'appliquent* **IT: Potresti VINCERE tu.** Termini e condizioni sono applicabili* **ES: Puedes GANAR.** Aplican términos y condiciones* **PT: Poderá GANHAR.** Aplicam-se termos e condições* **ZH: 轻松获奖. 条款和条件适用*** **PL: Szansa na WYGRANĄ.** Obowiązują warunki korzystania* **CS: Máte šanci VYHRÁT.** Platí všeobecné smluvní podmínky* **SK: Máte šancu VYHRAŤ.** Platia všeobecné zmluvné podmienky* **HU: TE IS NYERHETSZ.** Felhasználási feltételek érvényesek* **RO: Ai putea CÂȘTIGA.** Se aplică termeni și condiții* **BG: Можете да СПЕЧЕЛИТЕ.** Има определени правила и условия* **LV: Tu vari LAIMĒT.** Ir spēkā noteikumi un nosacījumi.* **ET: Sul on võimalus VÕITA.** Kehtivad tingimused* **LT: Jūs galite LAIMĖTI.** Taikomos sąlygos*

*[LEGO.com/productfeedback-terms](https://www.lego.com/productfeedback-terms)

LEGO and the LEGO logo are trademarks of the LEGO Group. ©2024 The LEGO Group.
©SEGA. All rights reserved. SEGA is registered in the U.S. Patent and Trademark Office.
SEGA and SONIC THE HEDGEHOG are either registered trademarks or trademarks of SEGA CORPORATION.

6494374