



DREAMWORKS
**GABBY'S
DOLLHOUSE**

10786





 **FR**
DONNEZ
OU
RECYCLEZ

 OU  OU 

ASSOCIATION MAGASIN DÉCHÈTERIE

Adresses sur quefairedemesdechets.fr



LEGO.com/sustainable-packaging



BUILDER



Apple and the Apple logo are trademarks of Apple Inc., registered in the U.S. and other countries and regions. App Store is a service mark of Apple Inc. Google Play and the Google Play logo are trademarks of Google LLC. Tencent and the Tencent logo are trademarks of Tencent Inc.

Q [LEGO.com/devicecheck](https://www.lego.com/devicecheck)

EN Ask parents' permission before going online | **DE** Eltern um Erlaubnis bitten, bevor du online gehst | **FR** Demande l'autorisation d'un parent avant d'aller en ligne | **IT** Chiedi il permesso ai tuoi genitori prima di andare online | **ES** Pídeles permiso a tus papás antes de conectarte a Internet | **PT** Pede autorização aos pais antes de acederes online | **ZH** 上网前应先征得父母的同意 | **PL** Poproś rodziców o zgodę, zanim wejdiesz do Internetu | **CS** Než půjdeš na internet, požádej rodiče o svolení | **SK** Skôr než pôjdeš na internet, vypýtaj si povolenie od rodičov | **HU** Kérj szülői engedélyt, mielőtt online csatlakoznál! | **RO** Cere permisiunea părinților înainte de a te conecta online | **BG** Поискайте разрешение от родител, преди да влезете онлайн | **LV** Pirms došanās tiešsaistē palūdz atļauju vecākiem | **ET** Enne Interneti kasutamist küsi vanematelt luba | **LT** Prieš prisijungdami prie interneto, atsiklauskite tėvų

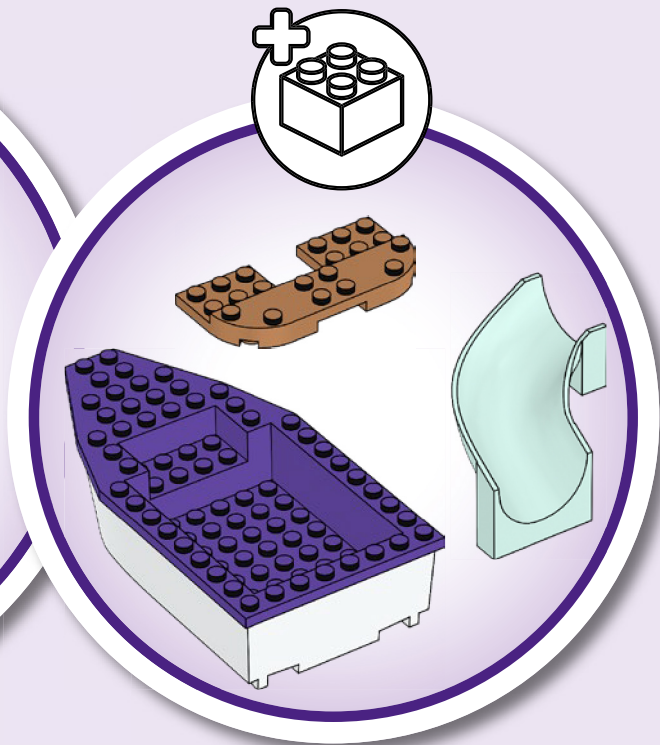

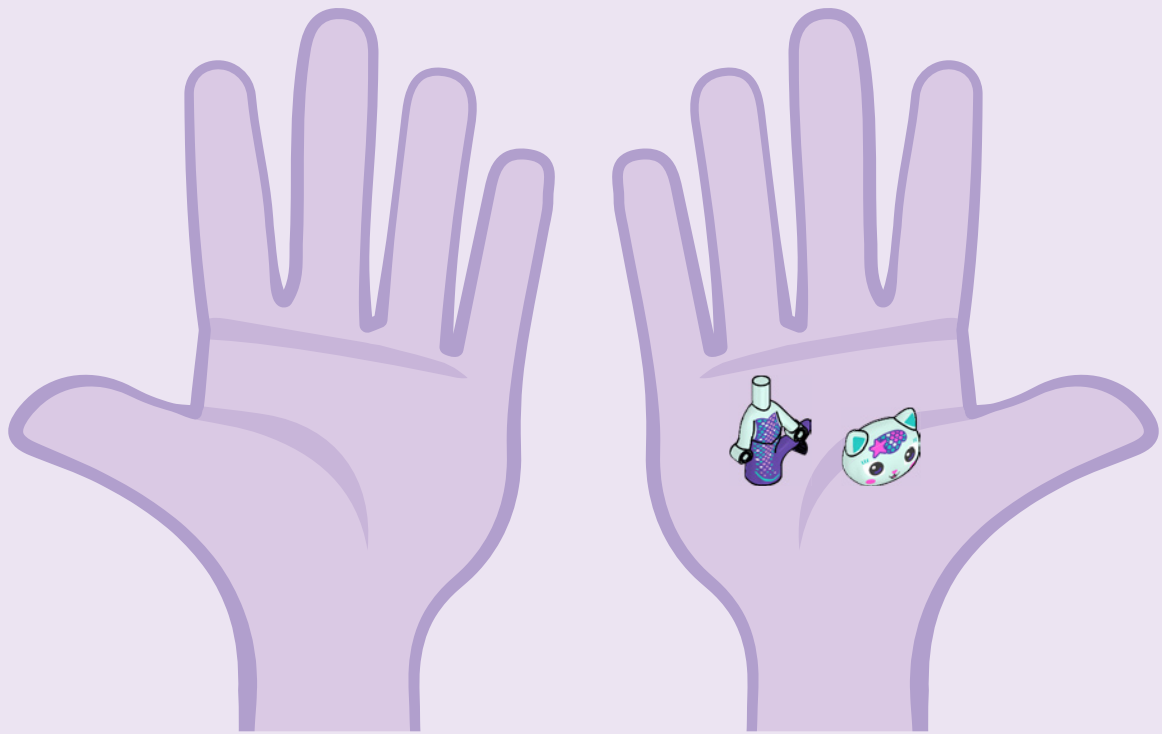

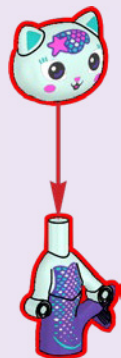

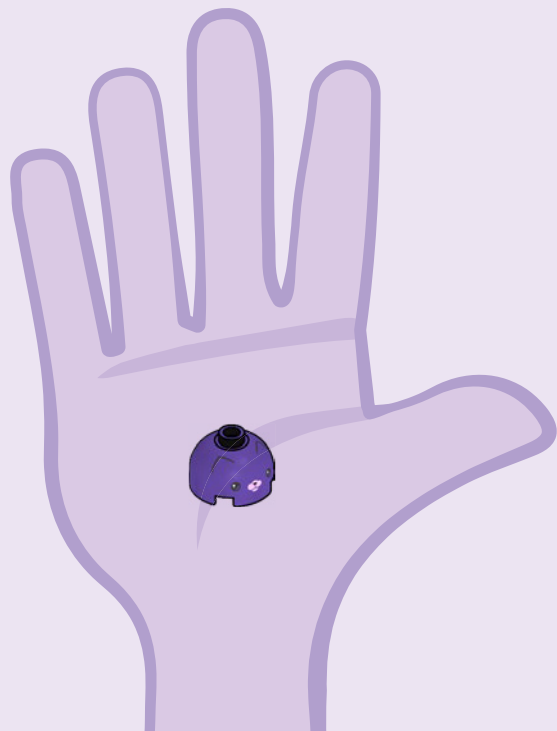



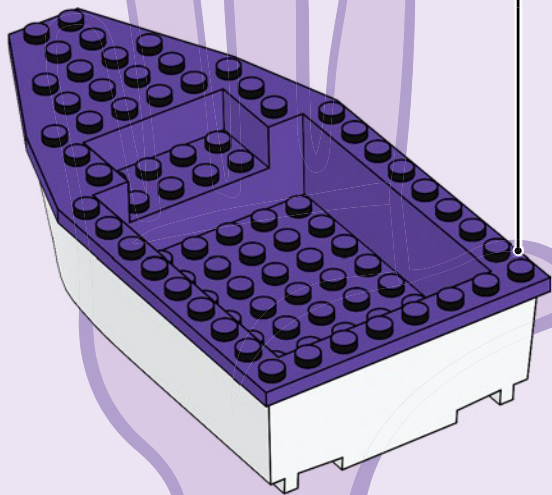
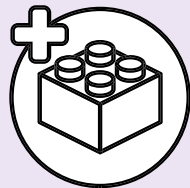

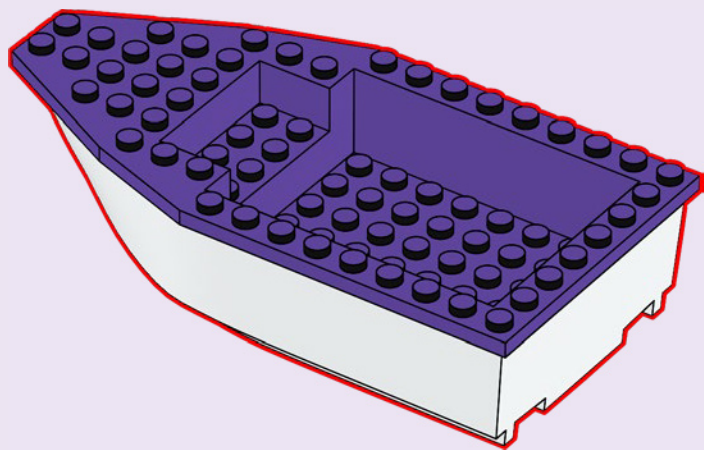

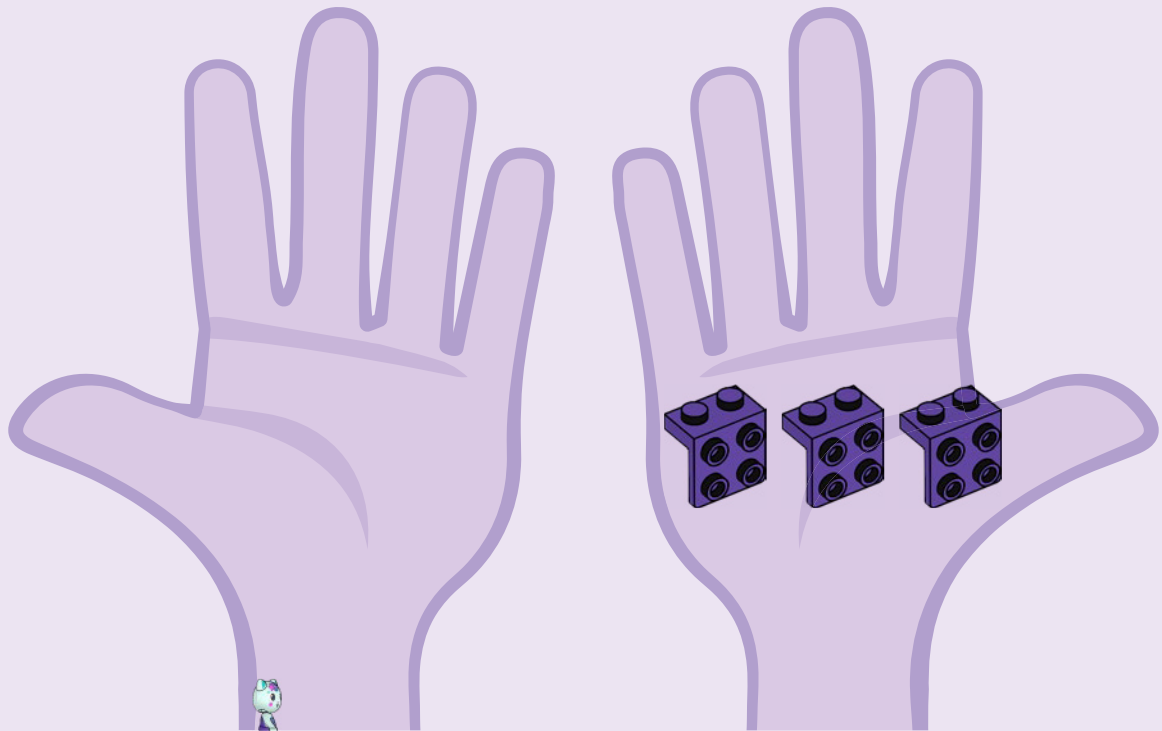

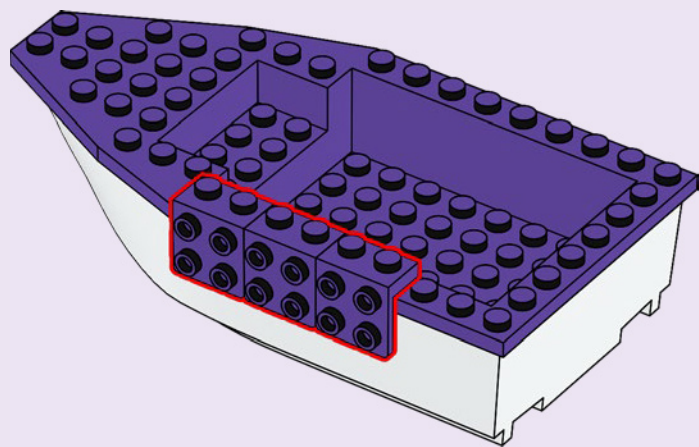

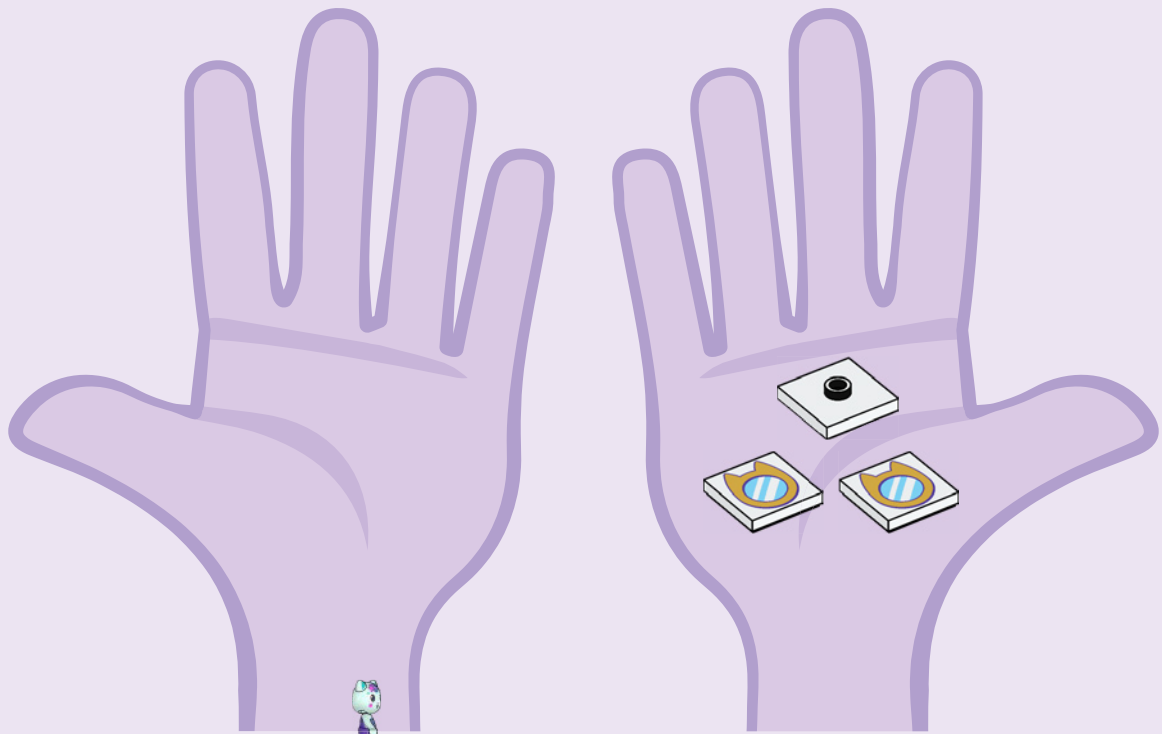

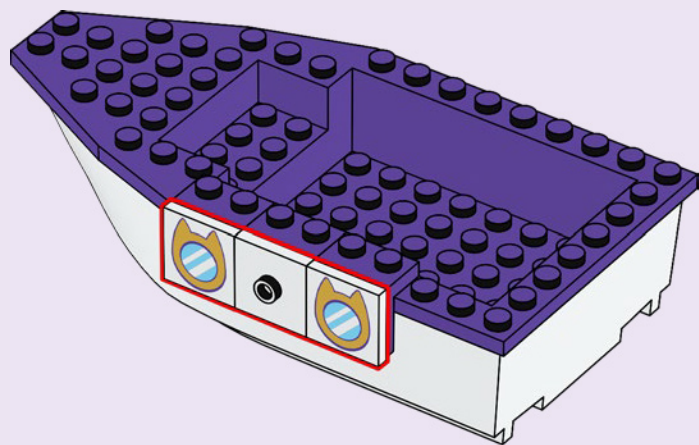

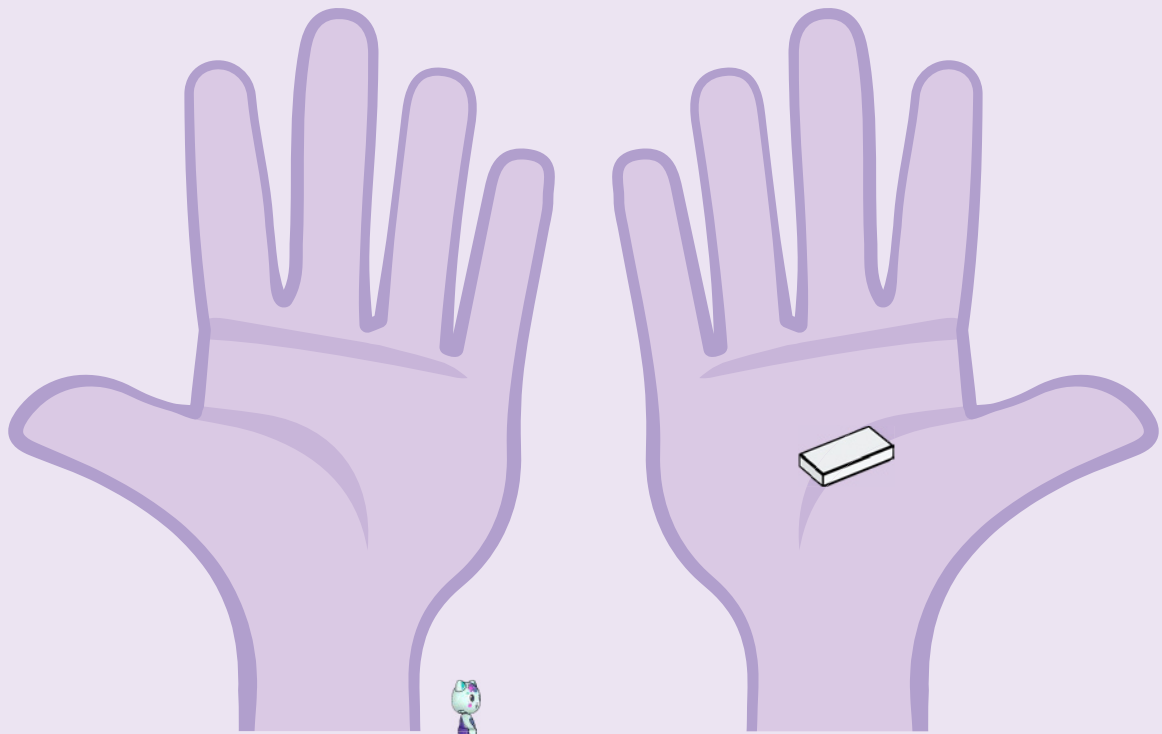

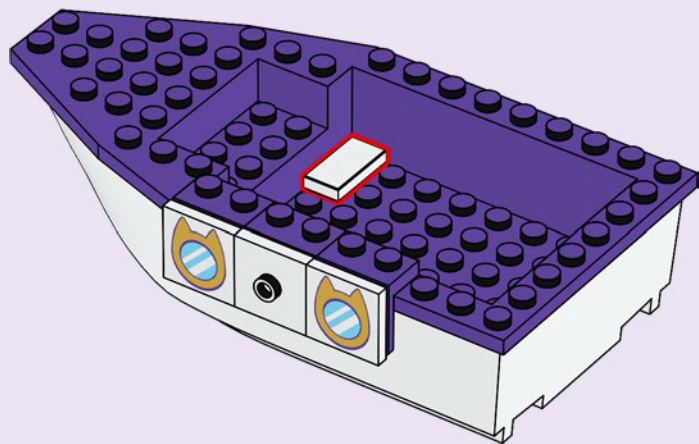

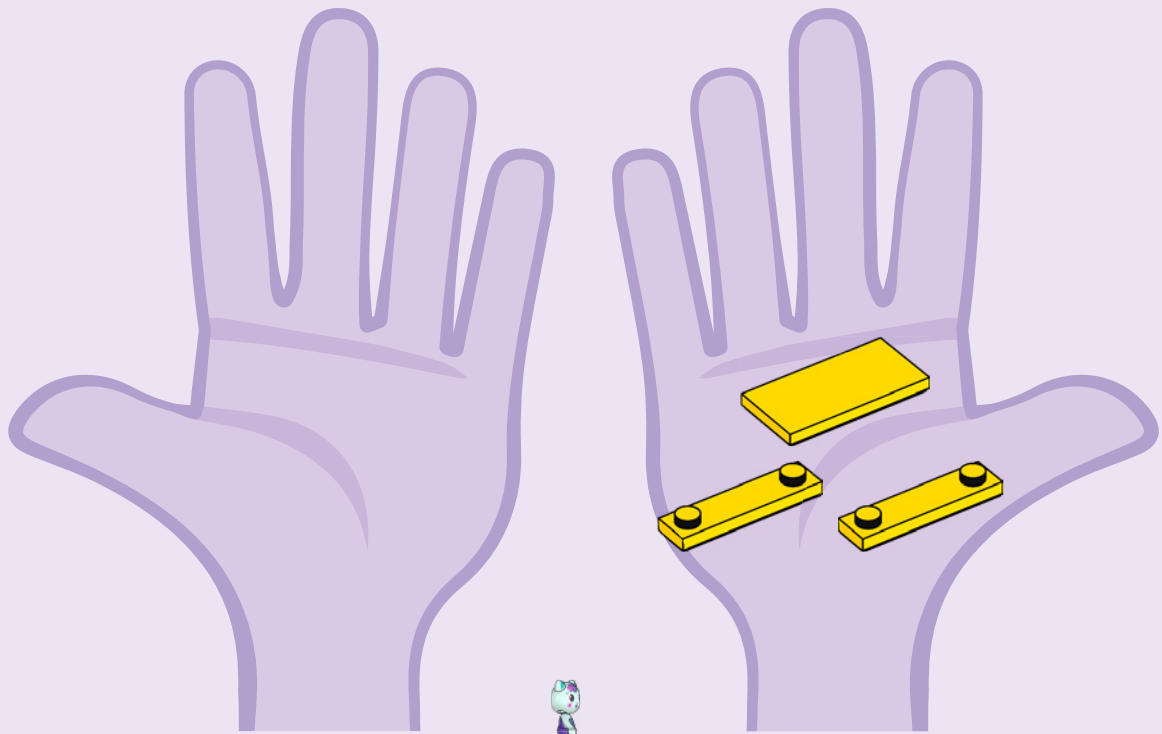

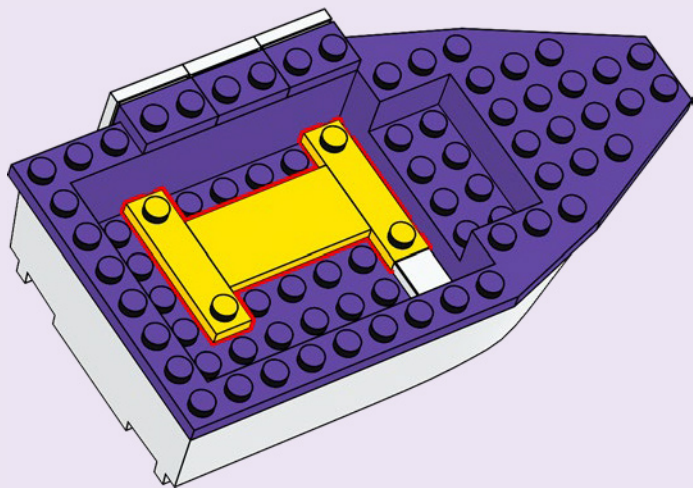

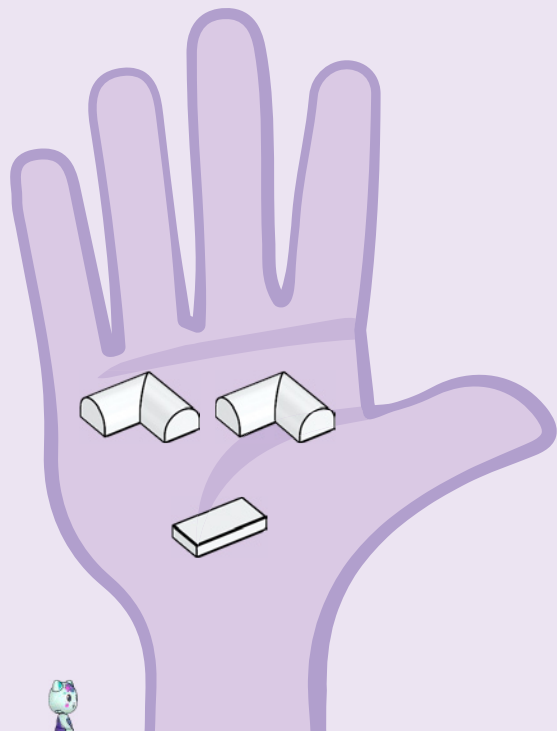
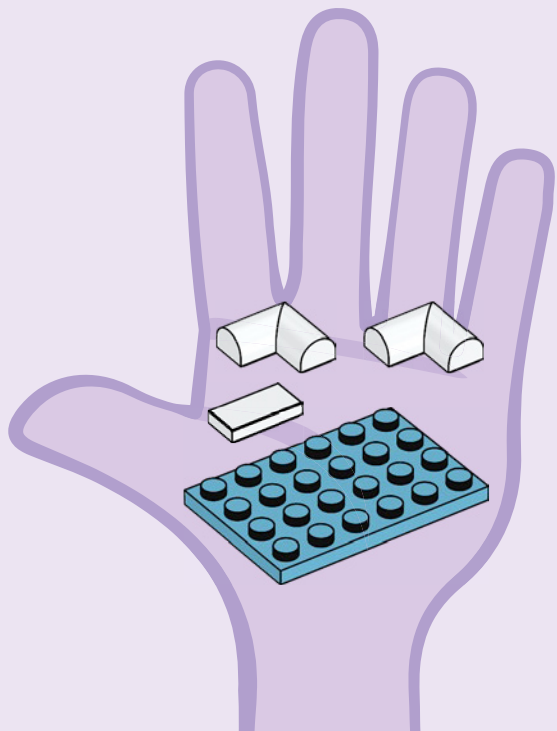

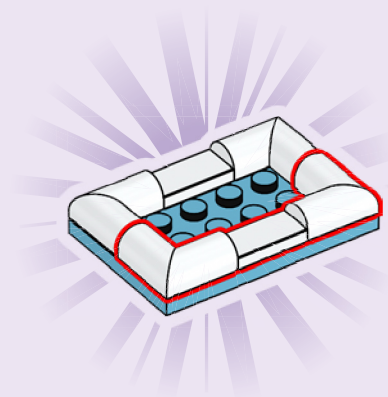
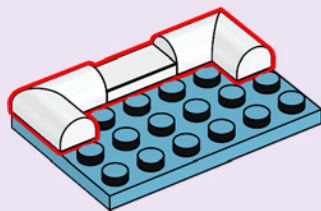
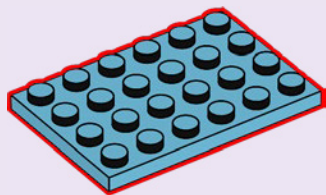

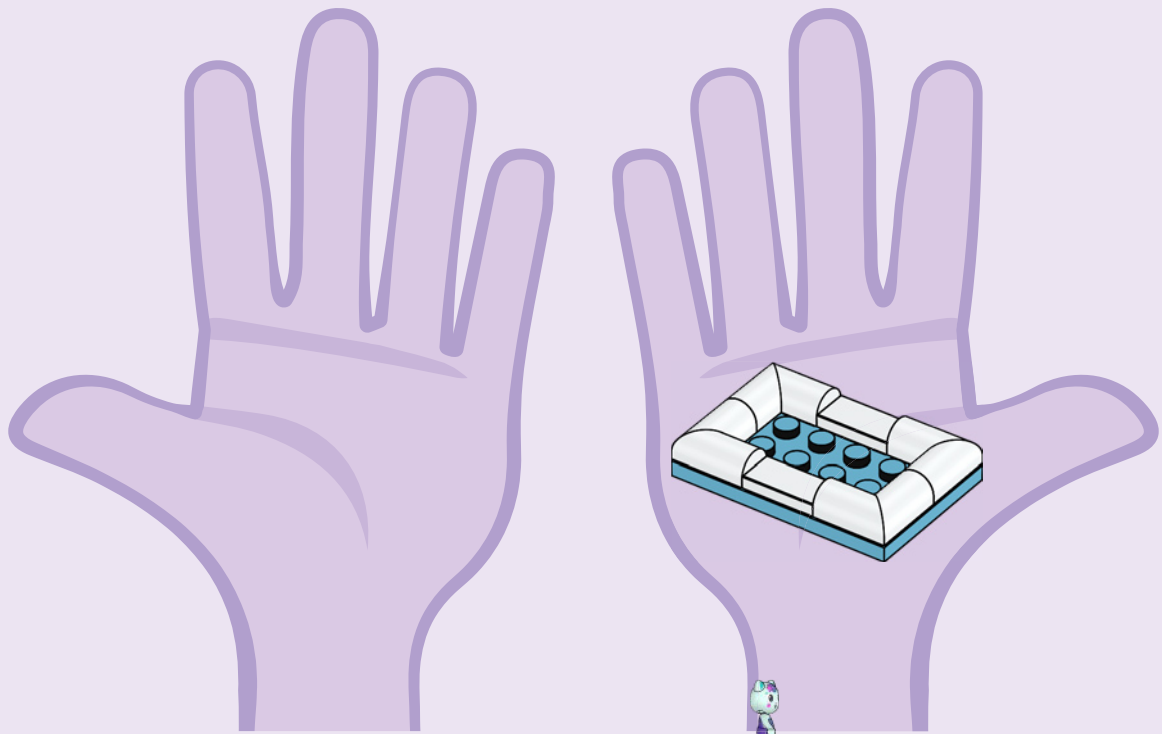

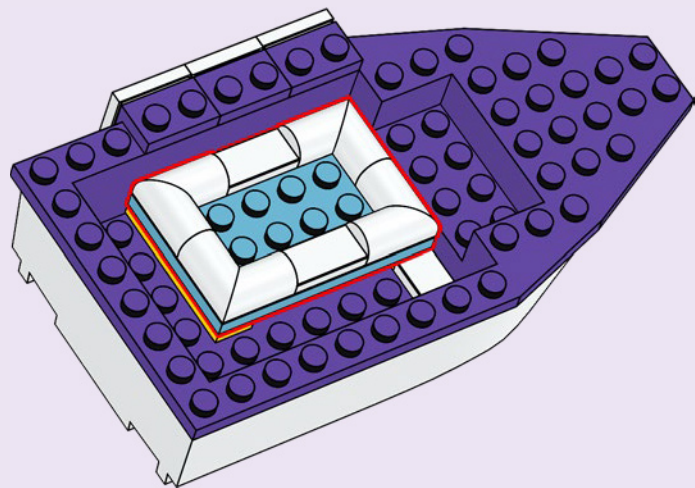

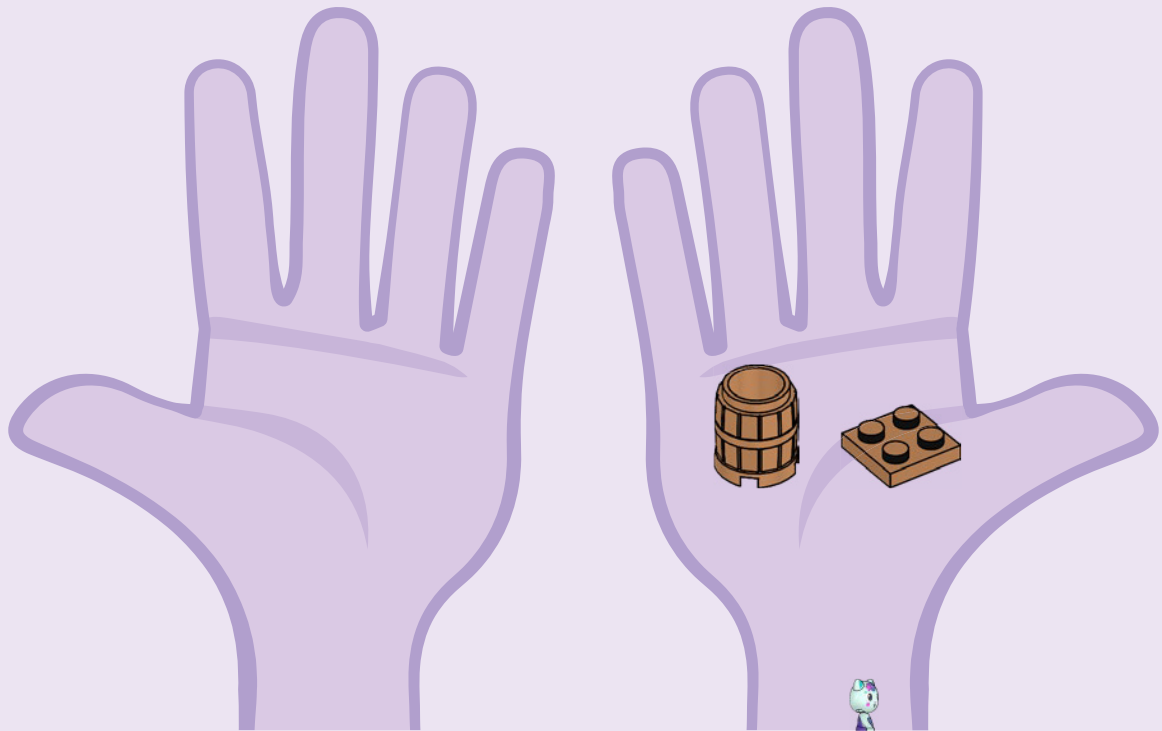

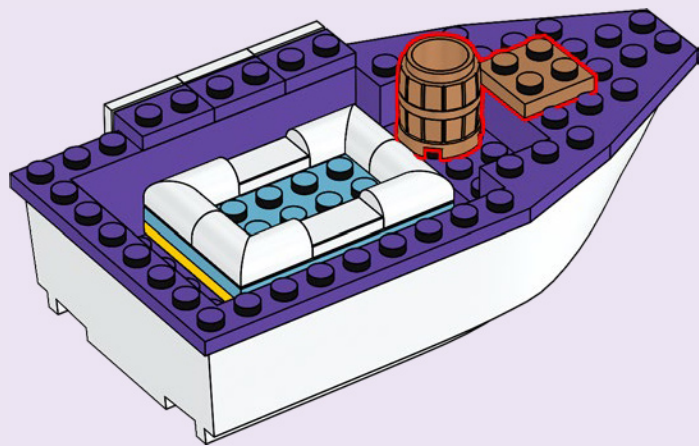

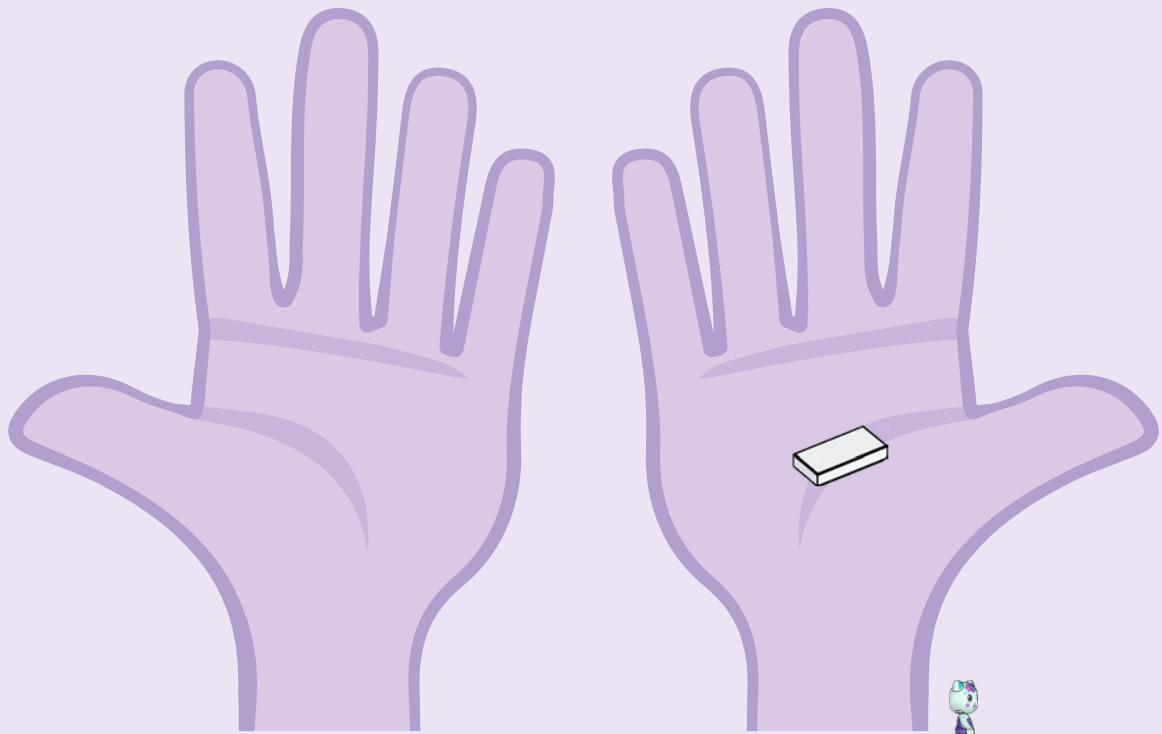

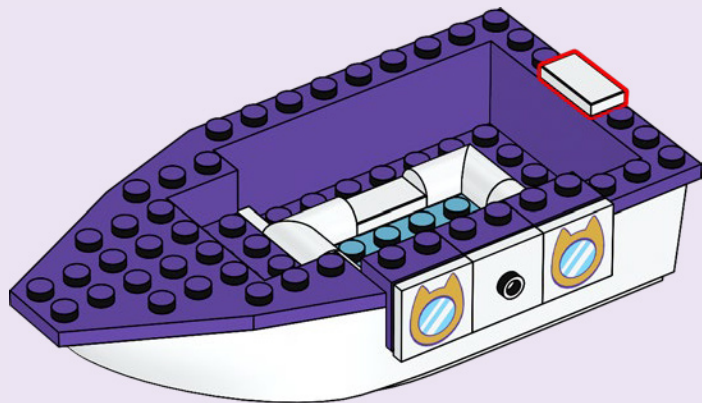

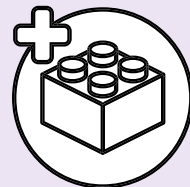
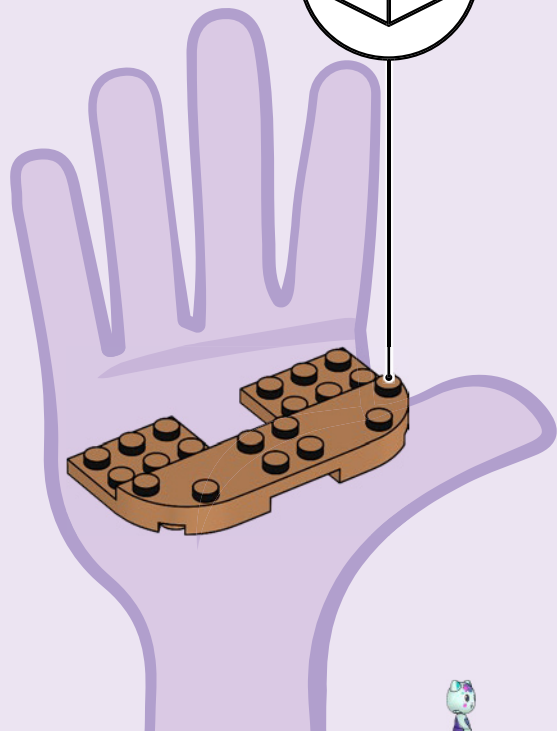

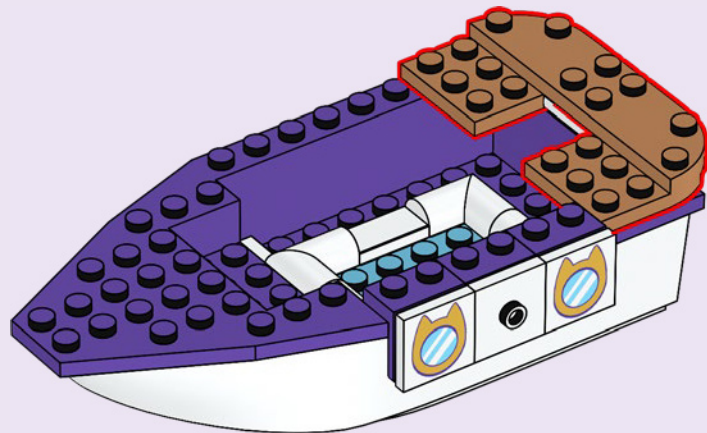

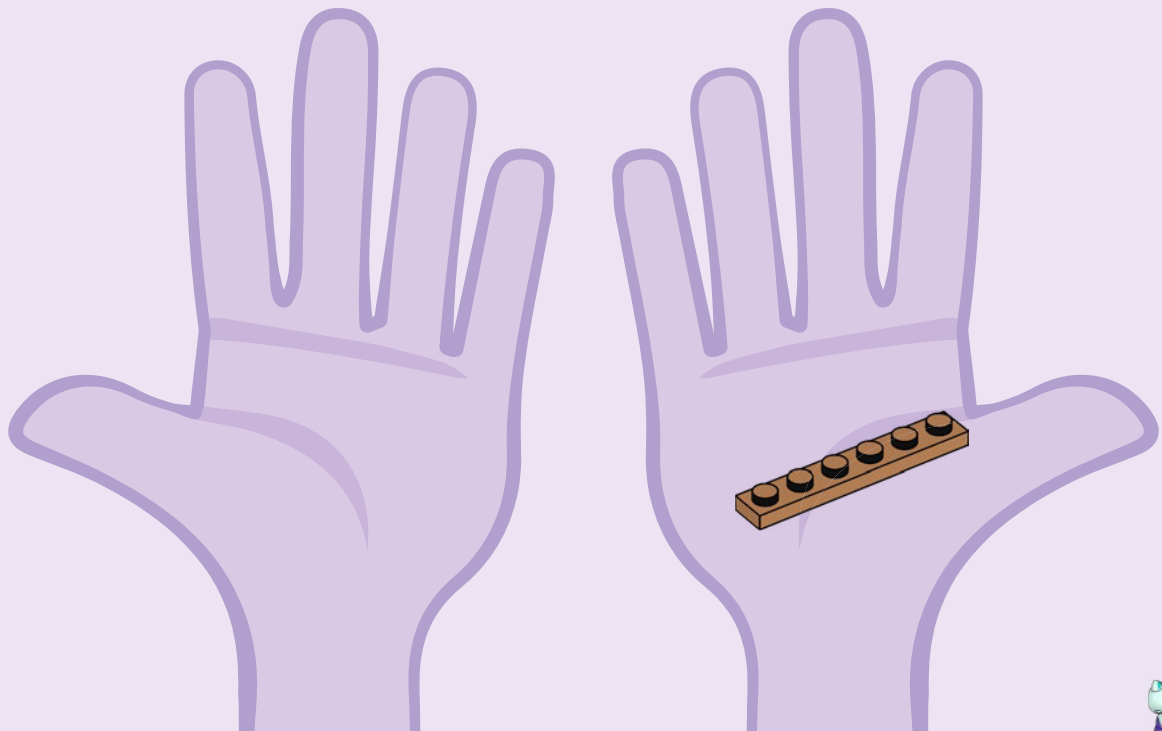

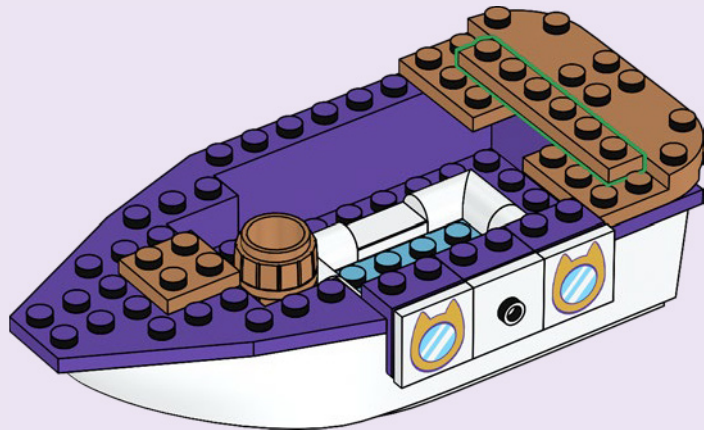

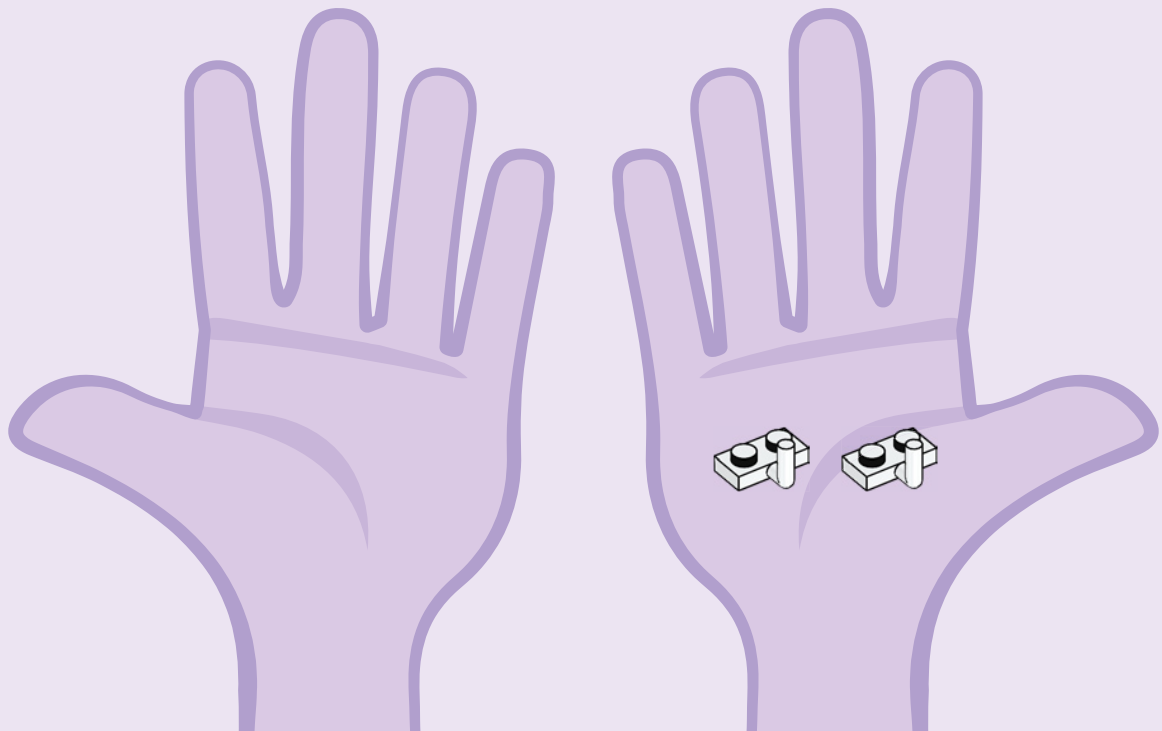

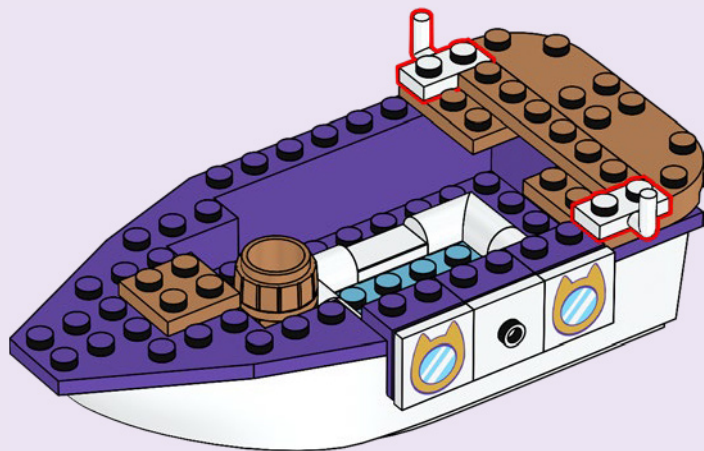

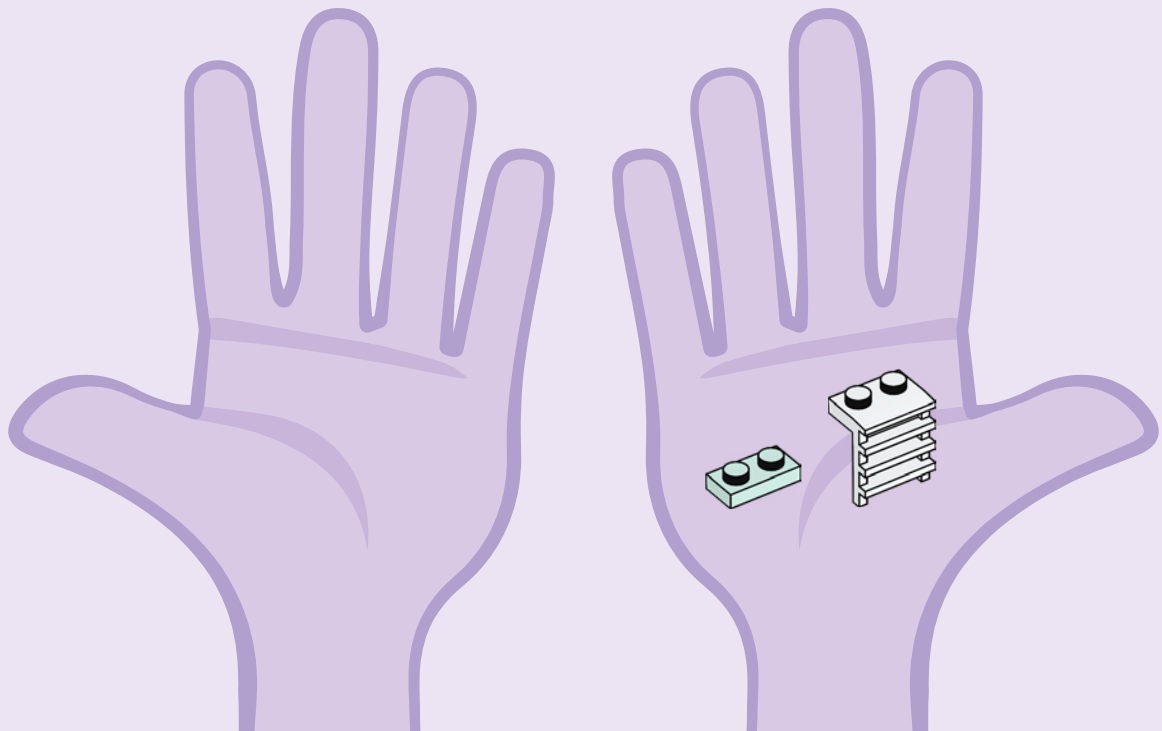

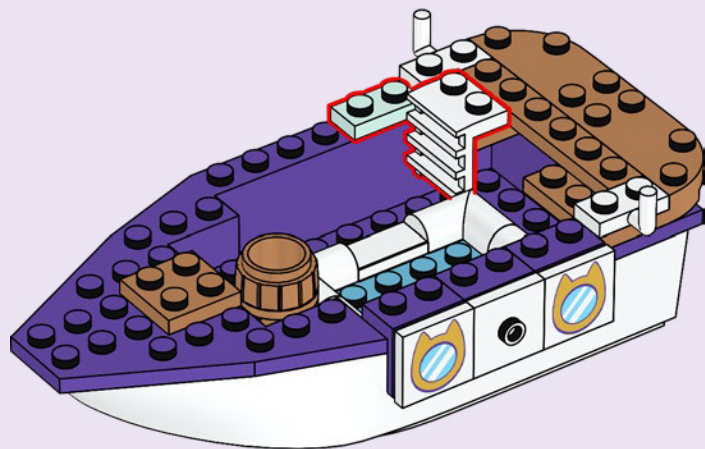

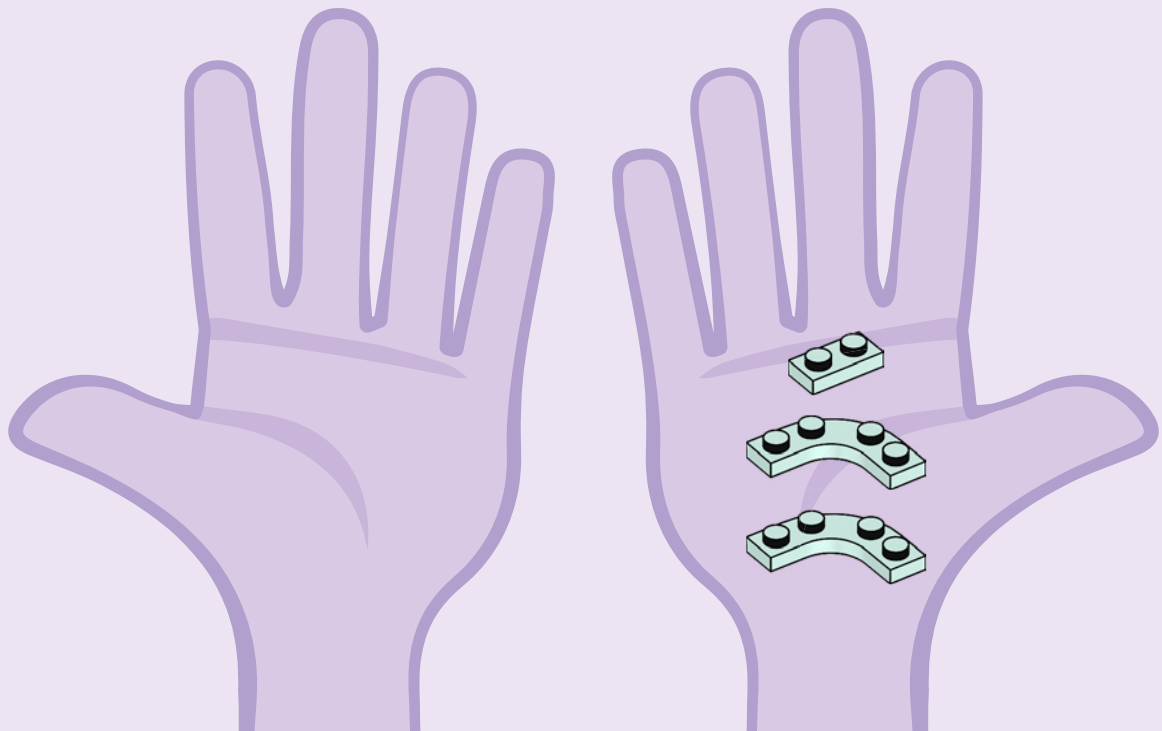

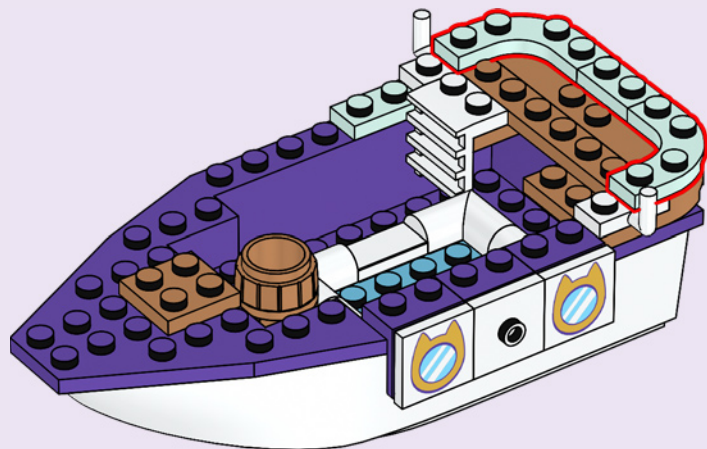

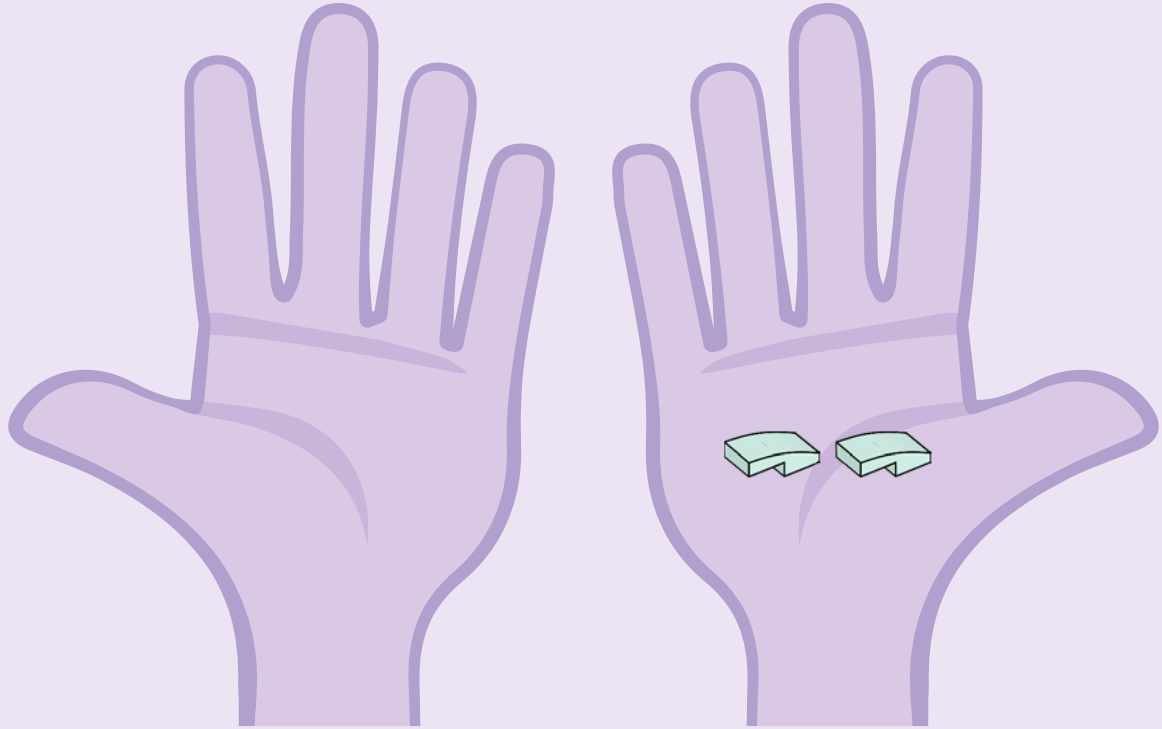

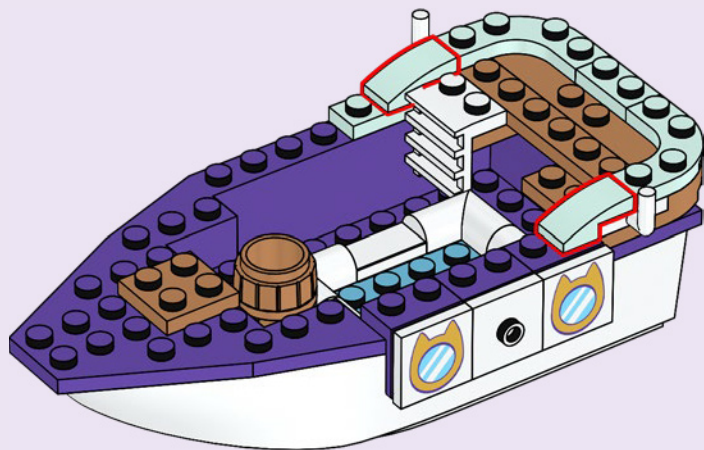

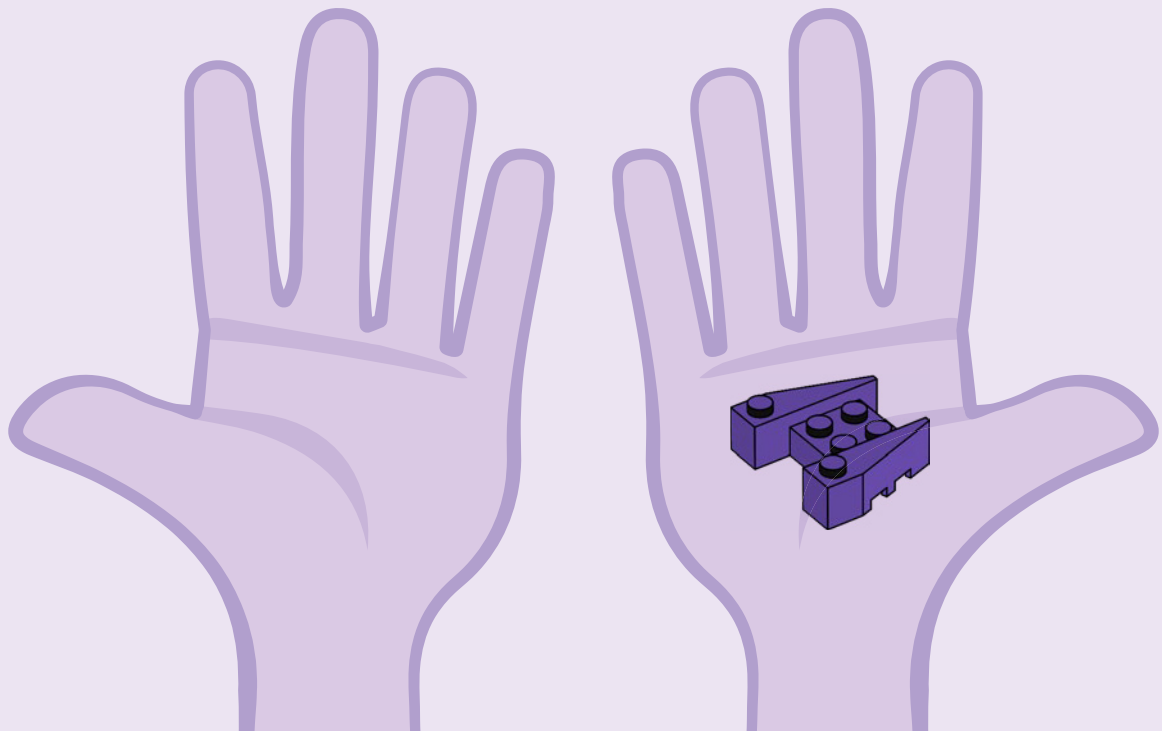

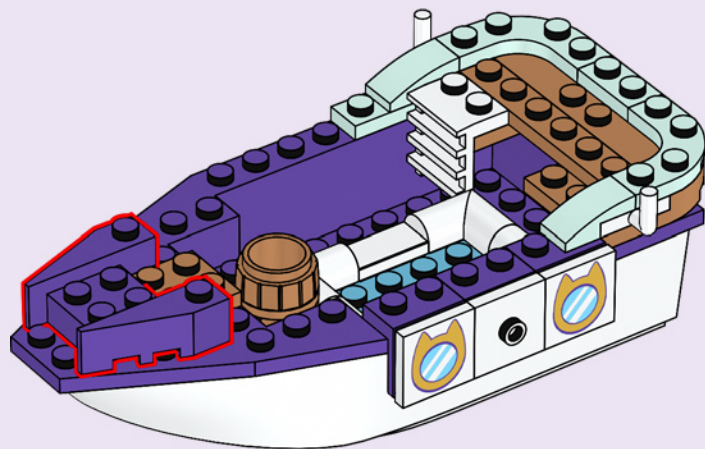

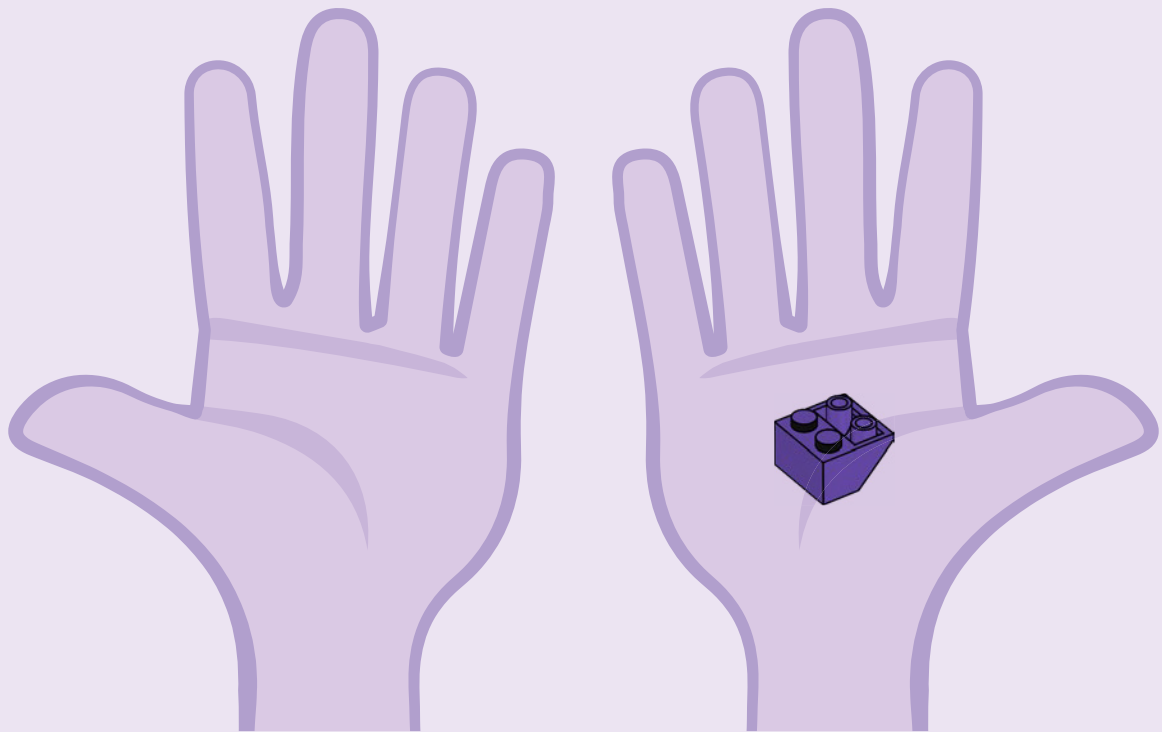

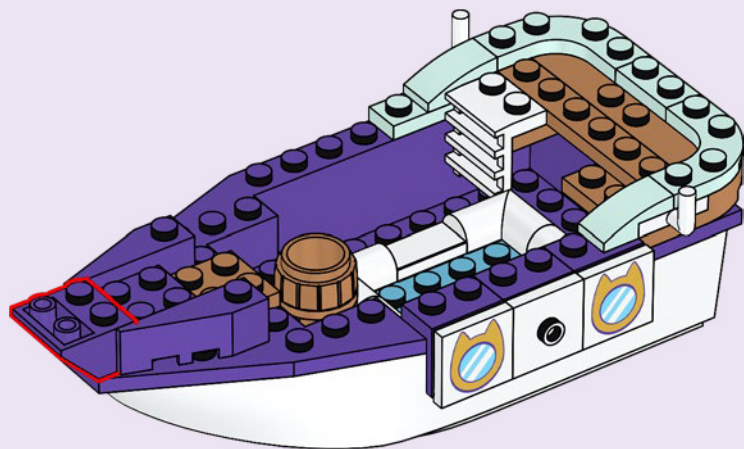

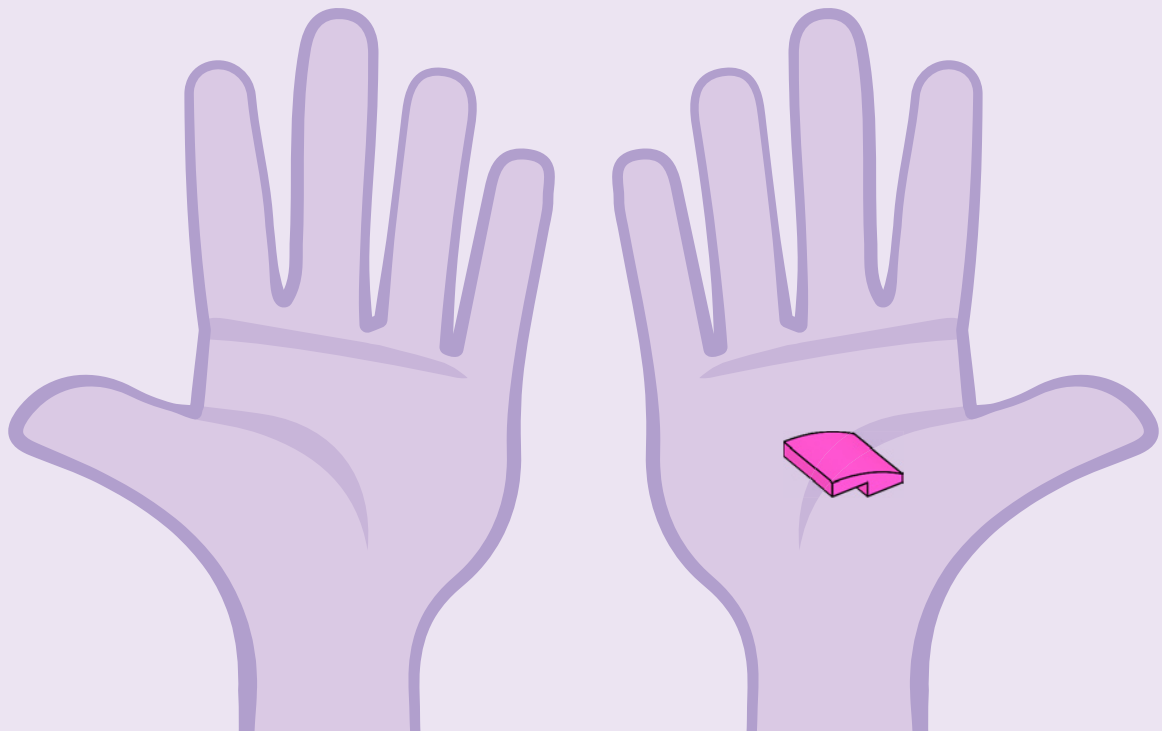

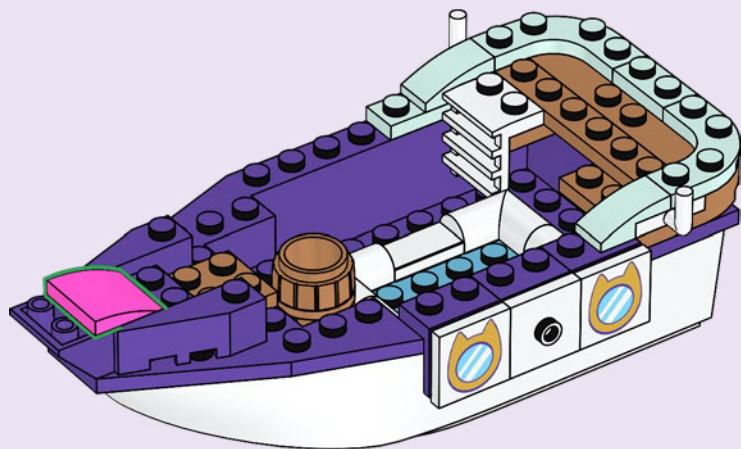

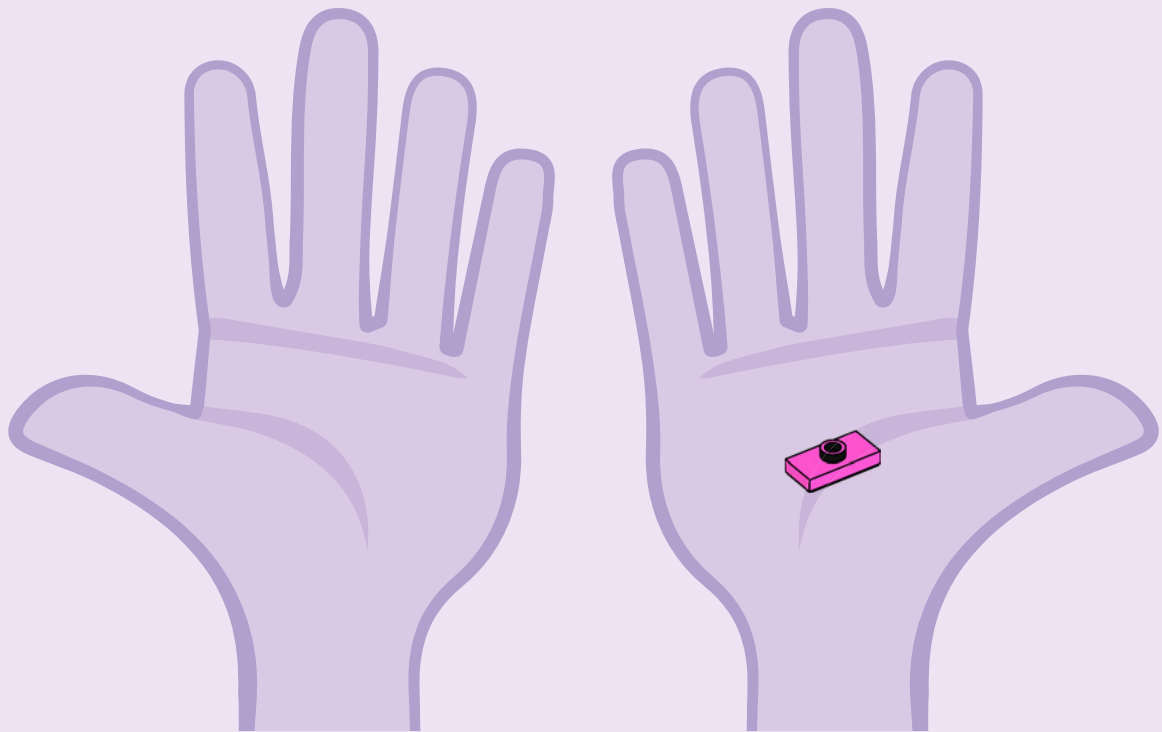

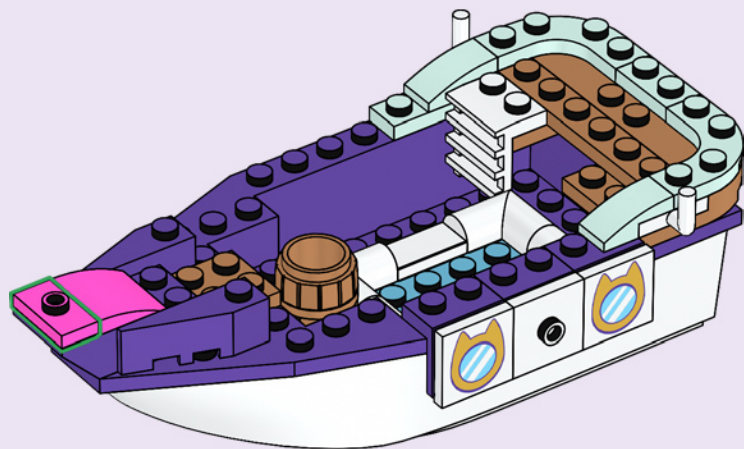

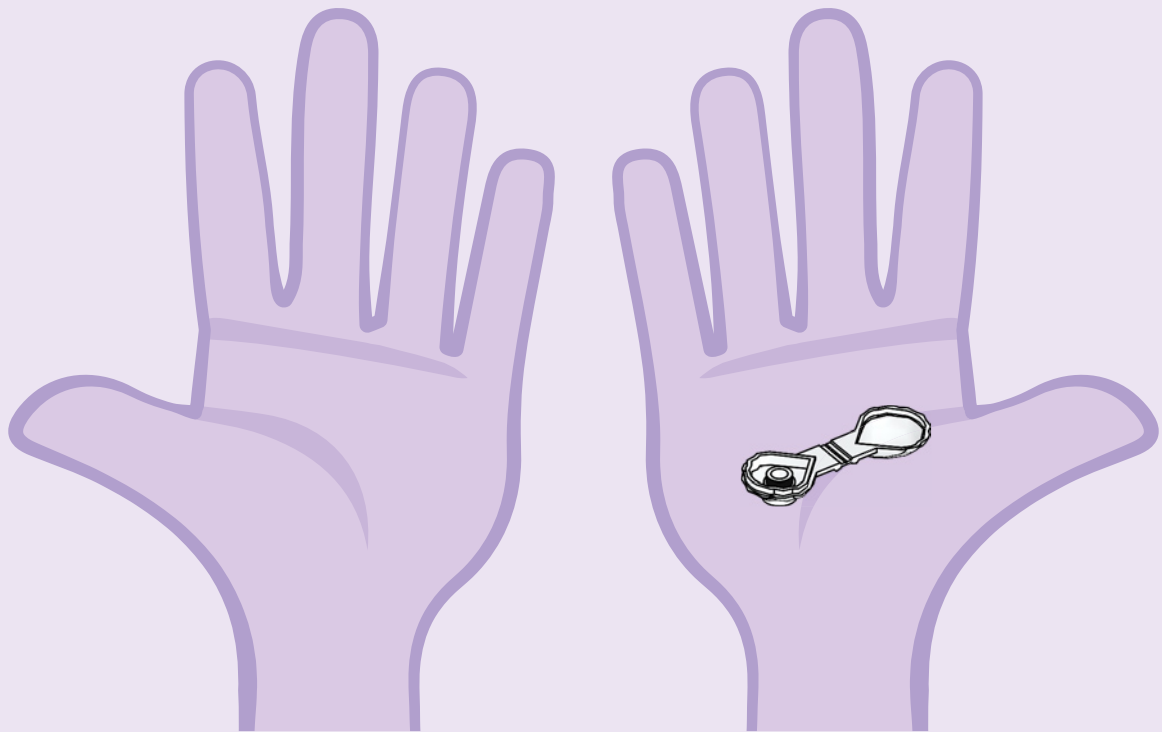

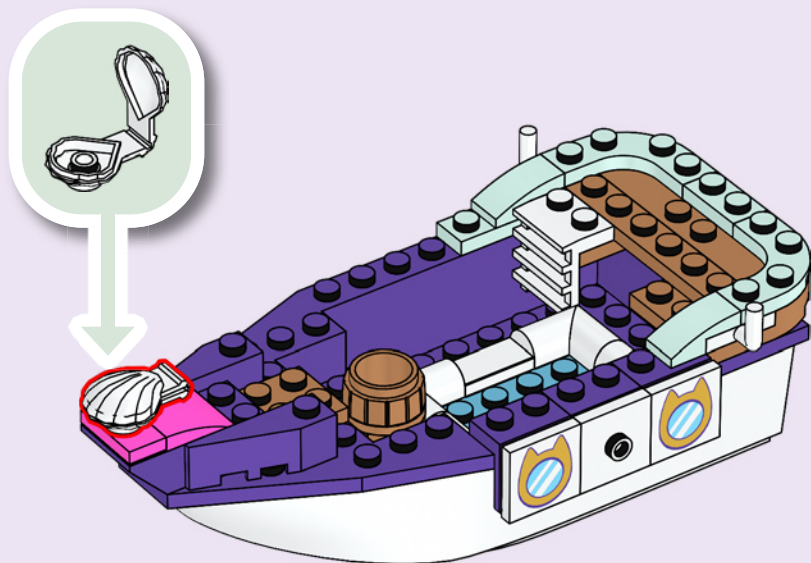

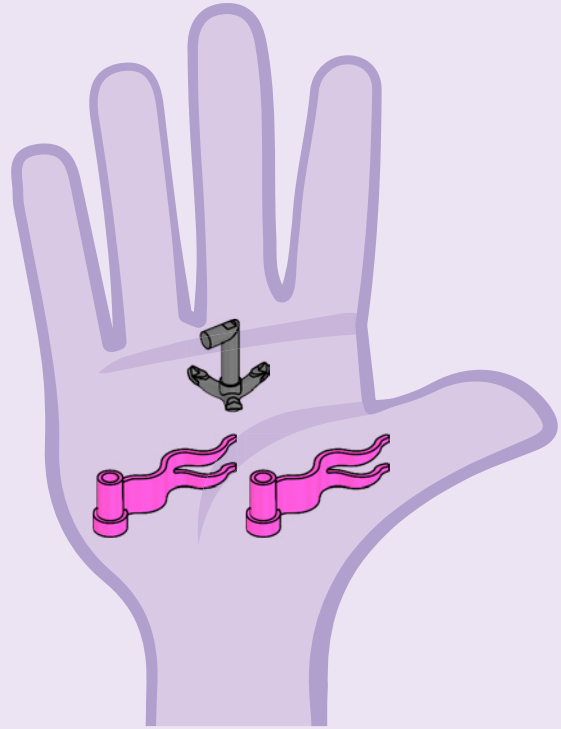

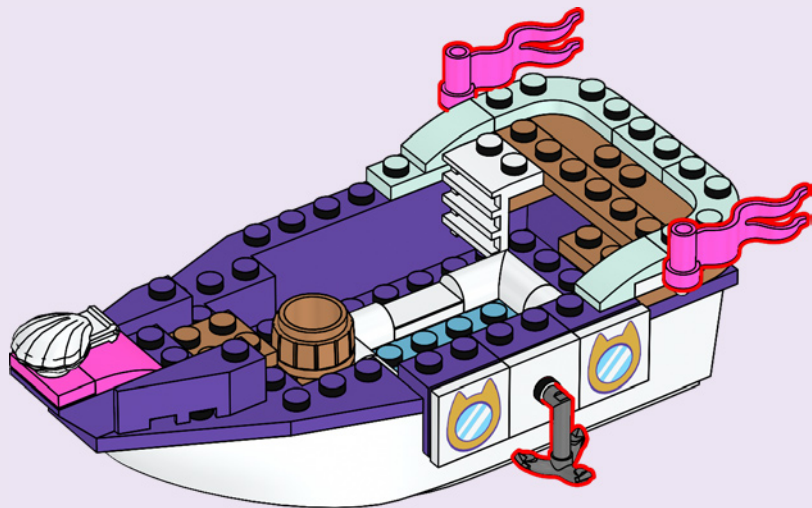

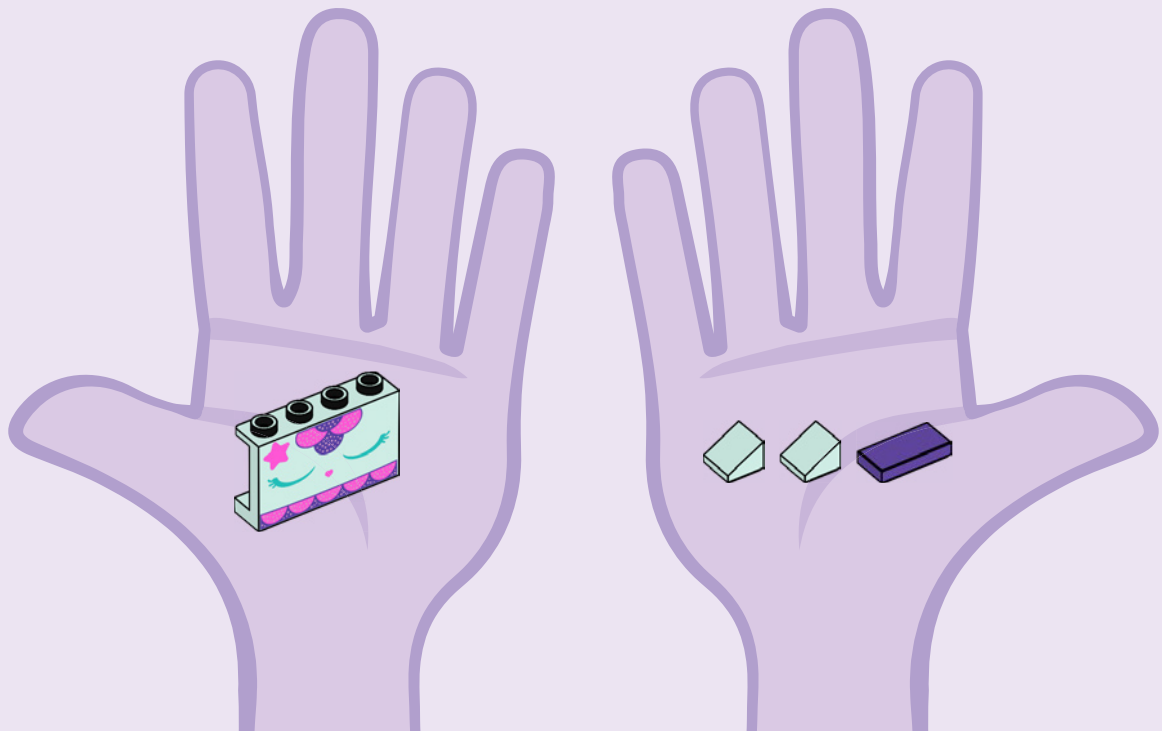

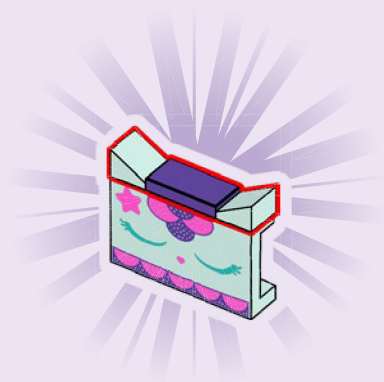
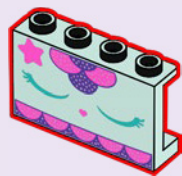

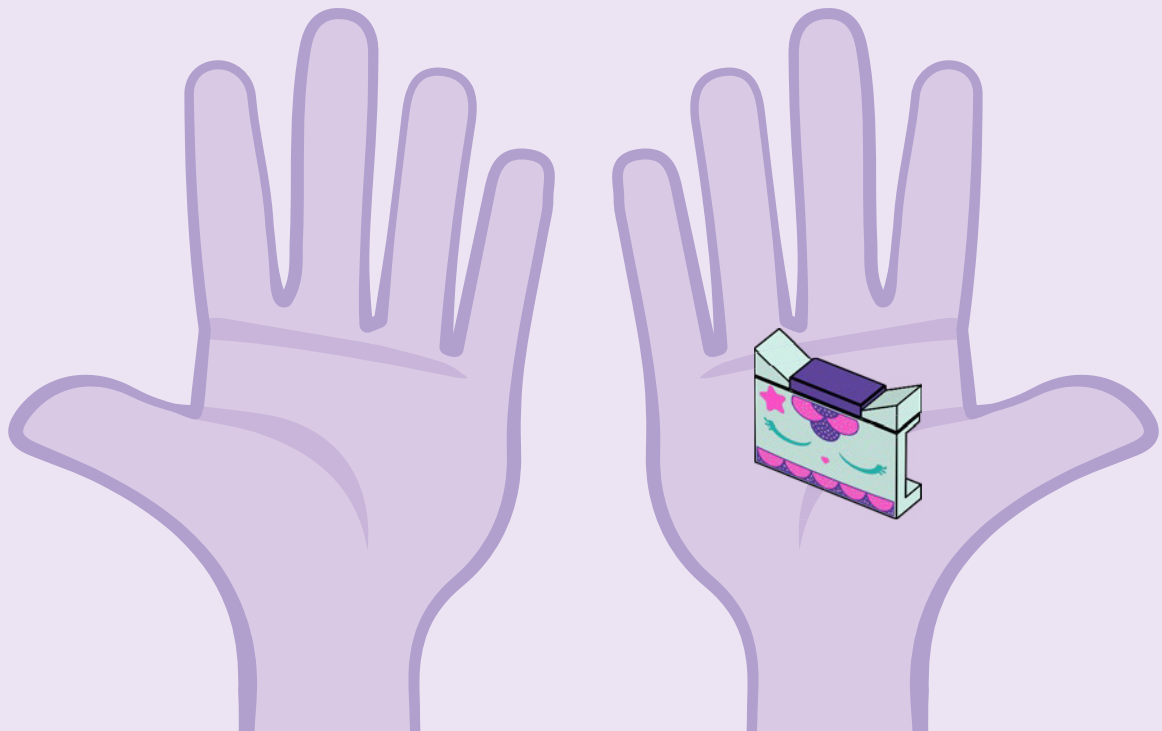

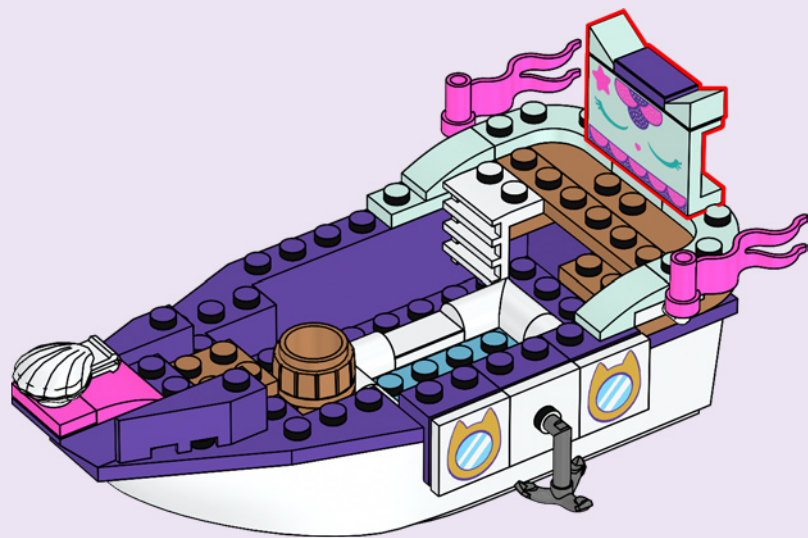

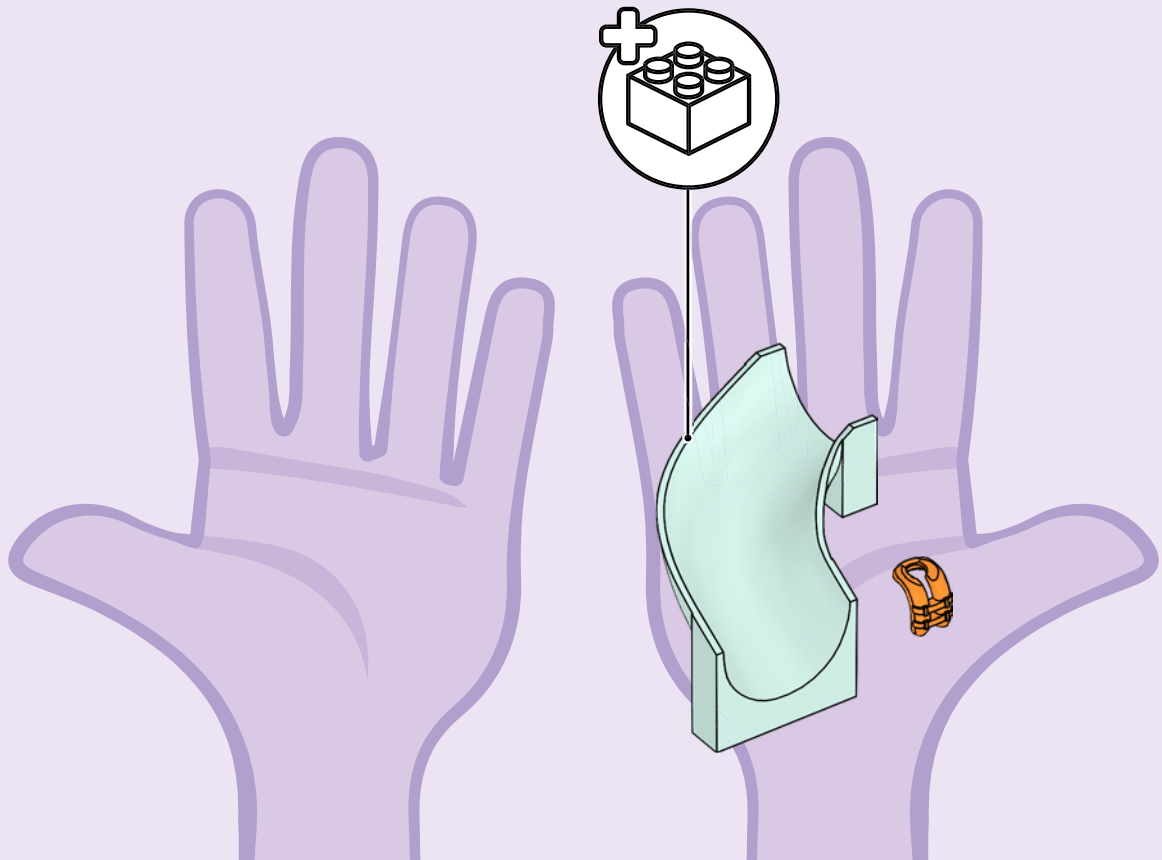

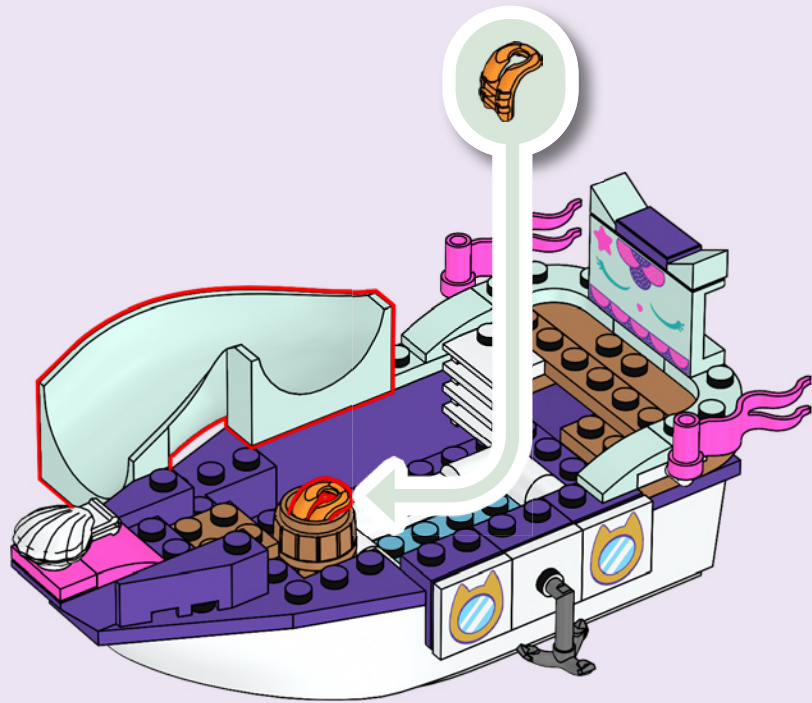





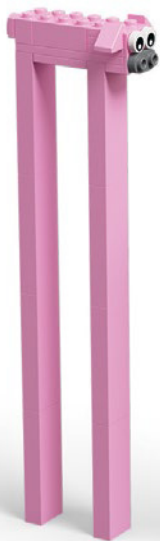

Rebuild
the
world™





DREAMWORKS GABBY'S DOLLHOUSE



10785



10786



10787



10788

4+

DreamWorks Gabby's Dollhouse © DreamWorks Animation LLC.
All rights reserved.





Rebuild
the
world™



1x
6452316

5x
306901

2x
6261349

1x
6248490

1x
6317345

3x
6446130

4x
6378417

1x
6126046

1x
6092203

1x
6097097

1x
6447110

1x
6454701

1x
4501232

1x
302224

2x
6257598

1x
4560181

1x
6447124

1x
6447125

1x
6447884

3x
6251841

2x
6429264

3x
6146701

2x
6141593

1x
6446129

2x
6447885

1x
6172588

1x
6337639

1x
6247792

1x
6337597

1x
6251291

1x
6136310

1x
6337637

1x
6247796

1x
6240042

1x
6096991

1x
6337632

2x
6432033

1x
6439231

1x
6253362

1x
6453279

1x
6223767

1x
6422439

1x
6217794

1x
6222189

2x
6268863

1x
6447119

2x
6264050

1x
4613192



3x
6334093

1x
6133921

1x
6238330

2x
4626935

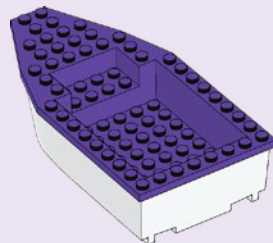
1x
6445124



1x
6445127

1x
6365629

1x
6056383

1x
6295464

1x
6353587

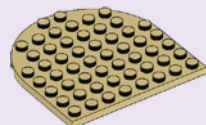

1x
6249092



1x
4619515

1x
6337269

1x
6058368

 [LEGO.com/service](https://www.lego.com/service)

YOU COULD **WIN**



Scan this QR code or go to **LEGO.COM/PRODUCTFEEDBACK** and give us your short feedback about this LEGO® set for a chance to win a cool LEGO prize.

Terms and Conditions apply*

EN: YOU COULD WIN. Terms and Conditions apply* **DE: Du könntest GEWINNEN.** Es gelten die Teilnahmebedingungen* **FR: Tu pourrais GAGNER.** Des conditions s'appliquent* **IT: Potresti VINCERE tu.** Termini e condizioni sono applicabili* **ES: Puedes GANAR.** Aplican términos y condiciones* **PT: Poderá GANHAR.** Aplicam-se termos e condições* **ZH: 轻松获奖. 条款和条件适用*** **PL: Szansa na WYGRANĄ.** Obowiązują warunki korzystania* **CS: Máte šanci VYHRÁT.** Platí všeobecné smluvní podmínky* **SK: Máte šancu VYHRAŤ.** Platia všeobecné zmluvné podmienky* **HU: TE IS NYERHETSZ.** Felhasználási feltételek érvényesek* **RO: Ai putea CÂȘTIGA.** Se aplică termenii și condiții* **BG: Можете да СПЕЧЕЛИТЕ.** Има определени правила и условия* **LV: Tu vari LAIMĒT.** Ir spēkā noteikumi un nosacījumi.* **ET: Sul on võimalus VÕITA.** Kehtivad tingimused* **LT: Jūs galite LAIMĖTI.** Taikomos sąlygos*

*[LEGO.com/productfeedback-terms](https://www.lego.com/productfeedback-terms)