

TCL

X937U

7.1.4 Channel Soundbar with RayDanz / Play-Fi / Dolby Atmos / DTS:X

Quick Start Guide



English | Albanian | Bulgarian | Croatian | Czech | Danish | Dutch | Estonian | Finnish | French | German | Greek | Hungarian | Italian | Latvian | Lithuanian | Macedonian | Norwegian | Polish | Portuguese | Romanian | Russian | Serbian | Slovak | Slovene | Spanish | Swedish | Turkish | Ukranian



EN Make sure you read all the safety information before you use this product.

SQ Sigurohuni që të lexoni të gjithë informacionin e sigurisë përpara se të përdorni produktin.

BG Преди да използвате продукта, задължително прочетете всички инструкции за безопасност.

HR Obavezno pročitajte sve sigurnosne informacije prije korištenja ovog proizvoda.

CS Před použitím tohoto výrobku si přečtěte všechny bezpečnostní informace.

DA Læs alle sikkerhedsoplysninger, før du bruger produktet.

NL Zorg ervoor dat u alle veiligheidsinformatie leest voordat u dit apparaat gebruikt.

ET Enne seadme kasutamist lugege kindlasti kõiki ohutuseeskirju.

FI Lue kaikki turvallisuusohjeet ennen tuotteen käyttöä.

FR Assurez-vous d'avoir lu toutes les informations relatives à la sécurité avant d'utiliser cet appareil.

DE Vergewissern Sie sich, dass Sie sämtliche Sicherheitshinweise gelesen haben, bevor Sie dieses Produkt verwenden.

EL Βεβαιωθείτε ότι έχετε διαβάσει όλες τις πληροφορίες ασφαλείας πριν χρησιμοποιήσετε αυτό το προϊόν.

HU A készülék használatba vétele előtt olvassa el az összes biztonsági előírást.

IT Assicurarsi di aver letto tutte le informazioni sulla sicurezza prima di utilizzare questo prodotto.

LV Pirms produkta lietošanas noteikti izlasiet visu drošības informāciju.

LT Prieš pradėjami naudoti šį gaminį, būtinai perskaitykite visus saugos nurodymus.

MK Погрижете се да ги прочитате сите безбедносни информации пред да го користите овој производ.

NO Sorg for å lese alle sikkerhetsinstruksjonene før du bruker produktet.

PL Przed użyciem produktu należy dokładnie przeczytać wszystkie wskazówki dotyczące bezpieczeństwa.

PT Certifique-se de ler todas as informações de segurança antes de usar este produto.

RO Asigurați-vă că ați citit toate informațiile de siguranță înainte de a utiliza acest produs.

RU Прежде чем приступить к эксплуатации устройства, прочтите все инструкции по безопасности.

SR Obavezno pročitajte sve informacije o bezbednosti pre upotrebe ovog proizvoda.

SK Pred použitím tohoto produktu si prečítajte všetky bezpečnostné informácie.

SL Zagotovite, da ste pred uporabo tega izdelka prebrali vse varnostne informacije.

ES Asegúrese de leer toda la información de seguridad antes de utilizar este producto.

SV Se till att du läser all säkerhetsinformation innan du använder produkten.

TR Bu ürünü kullanmadan önce tüm güvenlik bilgilerini okudüğünüzden emin olun.

UA Уважно ознайомтеся із усією інформацією стосовно техніки безпеки перед використанням пристрою.

A



B

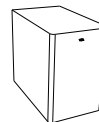

C

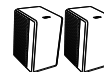

D x 2



E x 2



F



G

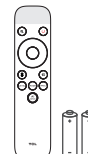

H

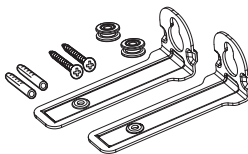

I

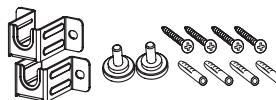

J

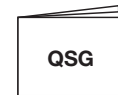

K

Safety
instructions

L

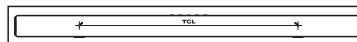

M

Warranty
card

2a



A

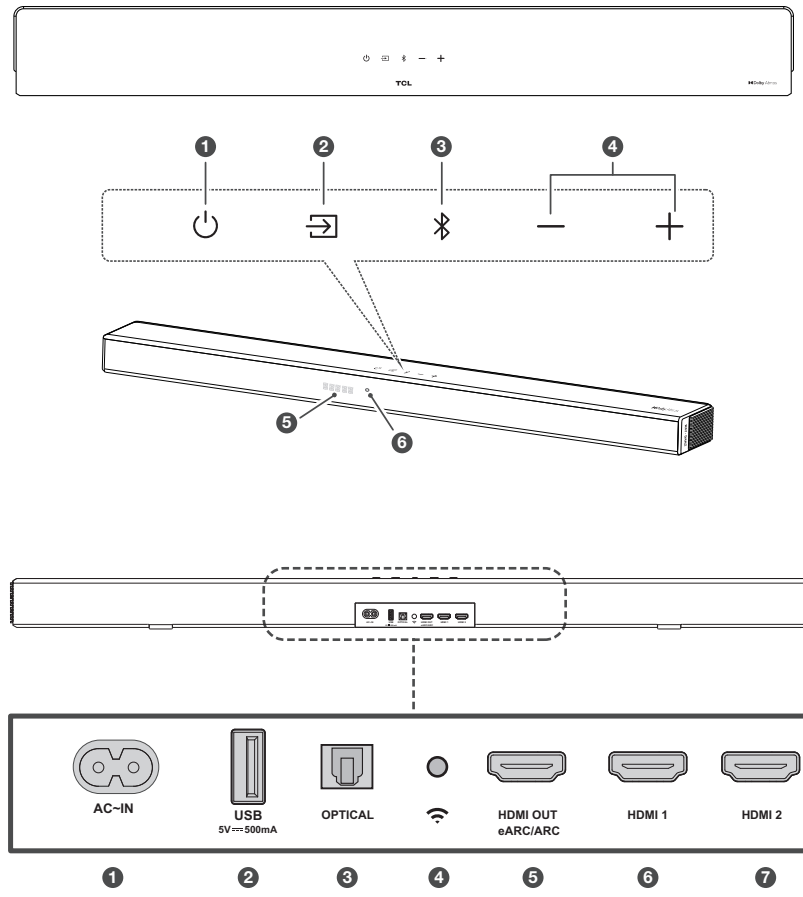

2b

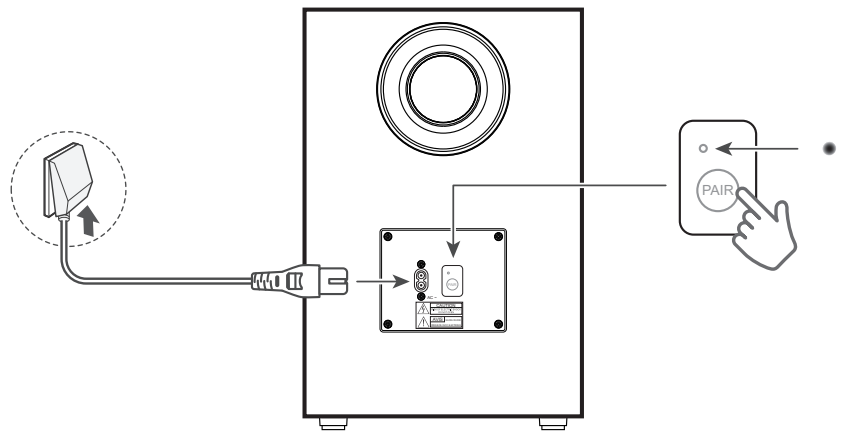

2c

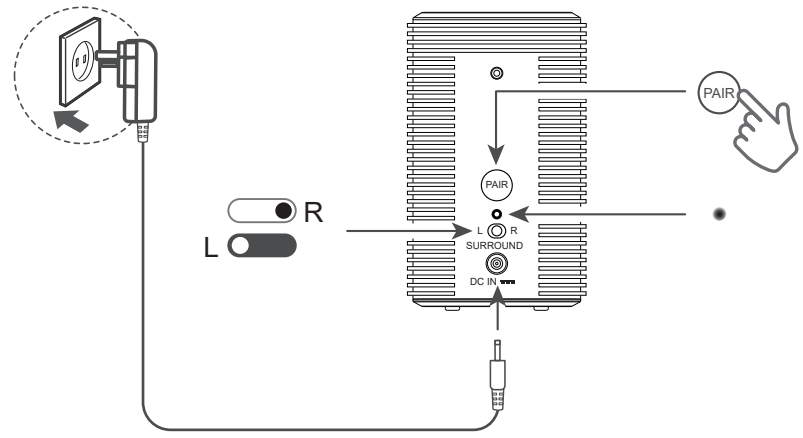

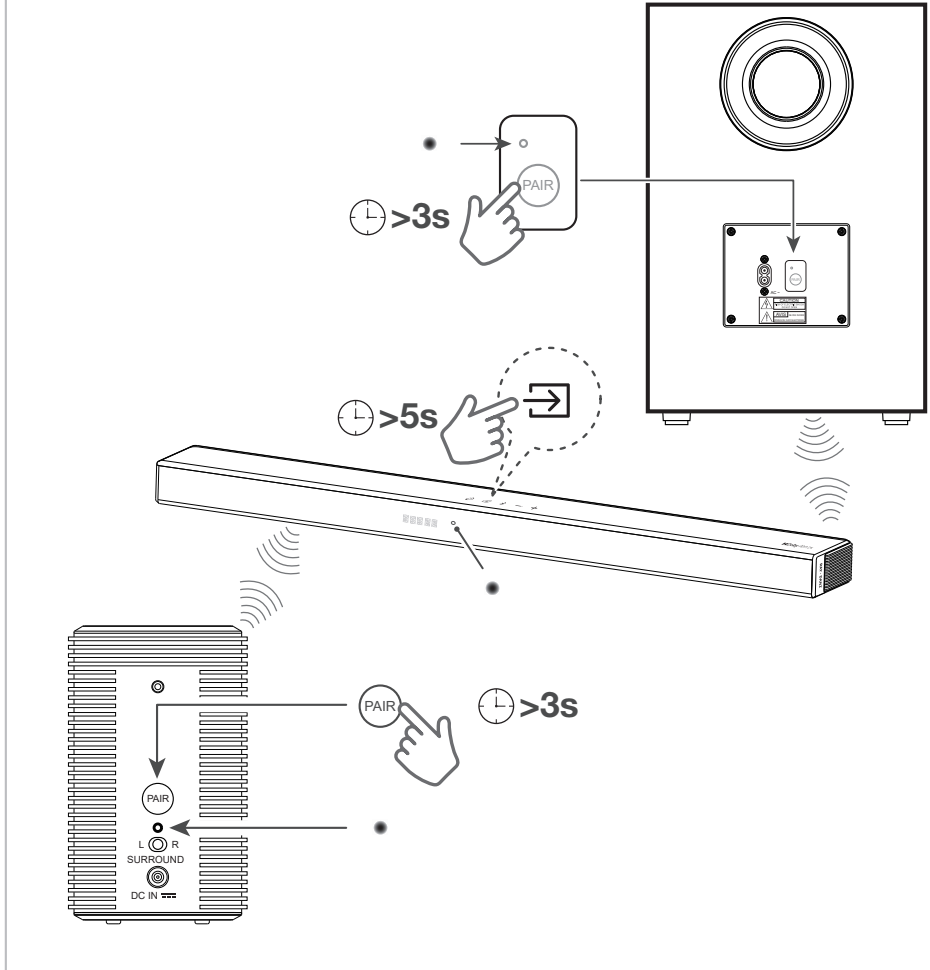

3

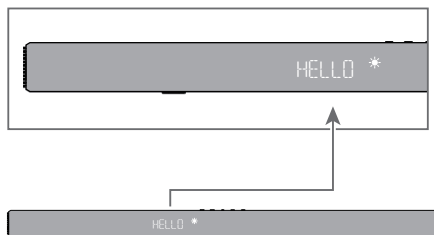

EN

	Soundbar Status	LED Display Status
Power	Power on Power off	HELLO STDBY / SLEEP
Source	HDMI eARC/ARC Optical USB Bluetooth HDMI 1 HDMI 2	ARC / eARC OPT USB BT HDMI1 HDMI2
Bluetooth	Searching mode (flashing) Pairing mode	BT PAIR
Volume control	Volume level Minimum volume reached Maximum volume reached Mute	V 36 MIN MAX MUTE
LEVEL	BASS (+/-) TREBLE (+/-) SurrVol (+/-) Dialogue Av Sync	BAS-S / BAS+S TRE-S / TRE+S SR-S / SR+S DIAL0 / DIAL6 SYNC
Sound modes	Standard/Voice/Music/Movie/ Game/Sports	STANDARD VOICE MUSIC MOVIE GAME SPORT
Sound EFFECT	BassBoost SurrEnhan Pass Throu Night NEURALX DRC LED DIM	BASBST ON / BASBST OFF SURRENH ON / SURRENH OFF PASSSTH ON / PASSSTH OFF NIGHT ON / NIGHT OFF BTSNEU ON / BTSNEU OFF BTSBRC LOW / BTSBRC MID / BTSBRC HIGH DIM 1 / DIM 2 / DIM 3

3

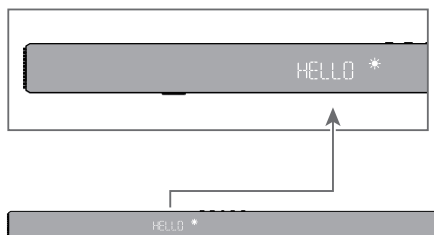

SQ

	Statusi i shiritit të zërit	Statusi i ekranit LED
Fuqia	Pushtet mbi Fike	HELLO STDBY / SLEEP
Burimi	HDMI eARC/ARC Optike USB Bluetooth HDMI 1 HDMI 2	ARC / eARC OPT USB BT HDMI1 HDMI2
Bluetooth	Modaliteti i kërkimit (pulsues) Modaliteti i çiftimit	BT PAIR
Kontrolli i volumit	Niveli i volumit Është arritur vëllimi minimal U arrit vëllimi maksimal Hesht	V 36 MIN MAX MUTE
NIVELI	BASS (+/-) TREBLA (+/-) Zëri rrethues (+/-) Dialogu Av Sync	BAS-S / BAS+S TRE-S / TRE+S SR-S / SR+S DIAL0 / DIAL6 SYNC
Mënyrat e zërit	Standard/Zëri/Muzikë/Film/ Lojë/Sport	STANDARD VOICE MUSIC MOVIE GAME SPORT
EFEKT TINGURI	Përforcimi i basit Përmirësimi rrethues Kalorj permes Natën NEURALX DRC	BASBST ON / BASBST OFF SURENH ON / SURENH OFF PASSTH ON / PASSTH OFF NIGHT ON / NIGHT OFF DTSNEU ON / DTSNEU OFF DTSBRC LOW / DTSBRC MID / DTSBRC HIGH
	LED DIM	DIM 1 / DIM 2 / DIM 3

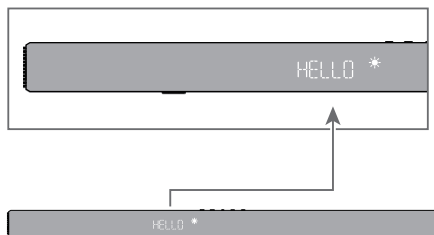

BG

		Състояние на звуковата лента	Състояние на LED дисплея
Мощност	Включено		HELLO
	Изключване		STDBY / SLEEP
Източник	HDMI eARC/ARC		ARC / eARC
	Оптичен		OPT
	USB		USB
	Bluetooth		BT
	HDMI 1		HDMI1
	HDMI 2		HDMI2
Bluetooth	Режим на търсене (мига)		BT
	Режим на сдвояване		PAIR
Контрол на звука	Ниво на силата на звука		V 36
	Достигнат е минимален обем		MIN
	Достигнат е максималният обем		MAX
	Заглушаване		MUTE
НИВО	БАСИ (+/-)		BAS-S / BAS+S
	ТРЕБЛИ (+/-)		TRE-S / TRE+S
	Съраунд глас (+/-)		SR-S / SR+S
	Диалог		DIAL0 / DIAL6
	Av Sync		SYNC
Звукови режими	Стандартно/Глас/Музика/Филм/ Игра/Спорт		STANDARD VOICE MUSIC MOVIE GAME SPORT
	Усилване на басите		BASBST ON / BASBST OFF
Звук ефект	Surround Enhance		SURENH ON / SURENH OFF
	Преминаване нощ		PASSTH ON / PASSTH OFF
	NEURALX		NIGHT ON / NIGHT OFF
	DRC		DTSNEU ON / DTSNEU OFF
			DTSBRC LOW / DTSBRC MID
			/ DTSBRC HIGH
	LED DIM		DIM 1 / DIM 2 / DIM 3



HR



	Status zvučne trake	Status LED zaslona
Vlast	Uključite napajanje Isključite napajanje	HELLO STDBY / SLEEP
Izvor	HDMI eARC/ARC Optički USB Bluetooth HDMI 1 HDMI 2	ARC / eARC OPT USB BT HDMI1 HDMI2
Bluetooth	Način pretraživanja (treperi) Način uparivanja	BT PAIR
Kontrola zvuka	Razina glasnoće Dostignut je minimalni volumen Dostignut je maksimalni volumen Isključi zvuk	V 36 MIN MAX MUTE
RAZINA	BASS (+/-) TREB (+/-) Surround glas (+/-) Dijalog Av Sync	BAS-S / BAS+S TRE-S / TRE+S SR-S / SR+S DIALOG / DIALOG SYNC
Načini zvuka	Standardno/Glas/Glazba/- Film/ Igra/Sport	STANDARD VOICE MUSIC MOVIE GAME SPORT
Zvučni EFEKT	Pojačanje basa Surround Enhance Proći kroz Noć NEURALX DRC LED DIM	BASBST ON / BASBST OFF SURENH ON / SURENH OFF PASSTH ON / PASSTH OFF NIGHT ON / NIGHT OFF DTSNEU ON / DTSNEU OFF DTSBRC LOW / DTSBRC MID / DTSBRC HIGH DIM 1 / DIM 2 / DIM 3

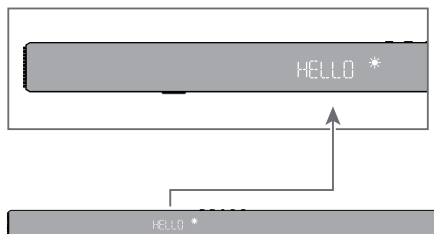

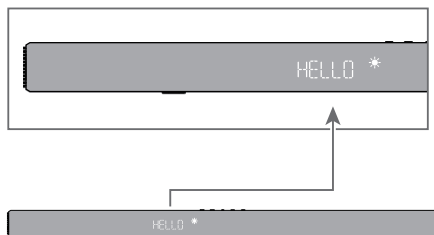

CS

	Stav zvukové lišty	Stav LED displeje
Napájení	Zapnutí Vypnout	HELLO STDBY / SLEEP
Zdroj	HDMI eARC/ARC Optický USB Bluetooth HDMI 1 HDMI 2	ARC / eARC OPT USB BT HDMI1 HDMI2
Bluetooth	Režim vyhledávání (blikající) Režim párování	BT PAIR
Ovládání hlasitosti	Úroveň hlasitosti Bylo dosaženo minimální hlasitosti Bylo dosaženo maximální hlasitosti Ztlumit	V 36 MIN MAX MUTE
ÚROVEŇ	BASS (+/-) VÝŠKY (+/-) Prostorový hlas (+/-) Dialog Av Sync	BAS-S / BAS+S TRE-S / TRE+S SR-S / SR+S DIALOG / DIALOG SYNC
Zvukové režimy	Standardní/Hlas/Hudba/Film/ Hra/Sport	STANDARD VOICE MUSIC MOVIE GAME SPORT
Zvukové EFEKTY	Zesílení basů Vylepšení prostorového zvuku Projíždět Noc NEURALX DRC LED DIM	BASBST ON / BASBST OFF SURENH ON / SURENH OFF PASSTH ON / PASSTH OFF NIGHT ON / NIGHT OFF DTSNEU ON / DTSNEU OFF DTSBRC LOW / DTSBRC MID / DTSBRC HIGH DIM 1 / DIM 2 / DIM 3

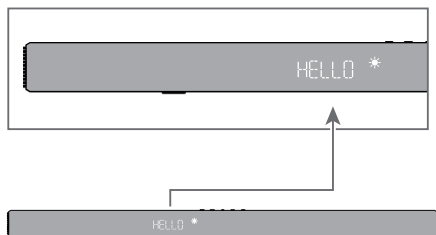

DA

	Soundbar Status	LED Display Status
Strøm	Tænd Sluk	HELLO STBY / SLEEP
Kilde	HDMI eARC/ARC Optisk USB Bluetooth HDMI 1 HDMI 2	ARC / eARC OPT USB BT HDMI1 HDMI2
Bluetooth	Søgetilstand (blinker) Parringstilstand	BT PAIR
Lydstyrkekontrol	Lydstyrkeniveau Minimumvolumen nået Maksimal volumen nået Stum	V 36 MIN MAX MUTE
NIVEAU	BAS (+/-) DISKANT (+/-) Surroundlyd (+/-) Dialog Av Sync	BAS-5 / BAS+5 TRE-5 / TRE+5 SR-5 / SR+5 DIALOG / DIALOG SYNC
Lydtilstande	Standard/Stemme/Musik/- Film/ Spil/Sport	STANDARD VOICE MUSIC MOVIE GAME SPORT
Lyd EFFEKT	Bass Boost Surround Enhance Gå igennem Nat NEURALX DRC LED DIM	BASBOOST ON / BASBOOST OFF SURRENH ON / SURRENH OFF PASSTH ON / PASSTH OFF NIGHT ON / NIGHT OFF DTSNEU ON / DTSNEU OFF DTSBRC LOW / DTSBRC MID / DTSBRC HIGH DIM 1 / DIM 2 / DIM 3

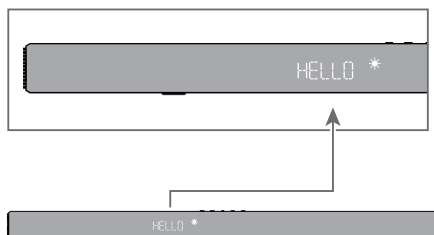

NL

	Soundbar-status	LED-displaystatus
Stroom	Inschakelen Uitschakelen	HELLO STDBY / SLEEP
Bron	HDMI eARC/ARC Optisch USB Bluetooth HDMI 1 HDMI 2	ARC / eARC OPT USB BT HDMI1 HDMI2
Bluetooth	Zoekmodus (knipperend) Koppelingsmodus	BT PAIR
Volumeregeling	Volumeniveau Minimaal volume bereikt Maximaal volume bereikt Stom	V 36 MIN MAX MUTE
NIVEAU	BAS (+/-) TREBLE (+/-) Surroundstem (+/-) Dialog Av Sync	BAS-S / BAS+S TRE-S / TRE+S SR-S / SR+S DIALOG / DIALOG SYNC
Geluidsmodi	Standaard/Stem/Muziek/- Film/ Game/Sport	STANDARD VOICE MUSIC MOVIE GAME SPORT
Geluidseffect	Basversterking Surround-verbetering Doorgang Nacht NEURALX DRC LED DIM	BASBST ON / BASBST OFF SURENH ON / SURENH OFF PASSTH ON / PASSTH OFF NIGHT ON / NIGHT OFF DTSNEU ON / DTSNEU OFF DTSBRC LOW / DTSBRC MID / DTSBRC HIGH DIM 1 / DIM 2 / DIM 3

3

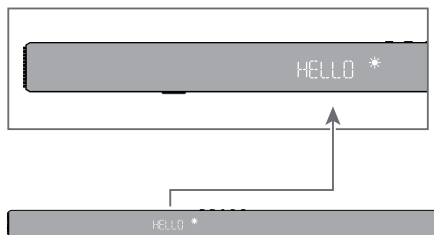

ET

	Heliriba olek	LED-ekraani olek
Võimsus	Toide sisse Toide välja	HELLO STBY / SLEEP
Allikas	HDMI eARC/ARC Optiline USB Bluetooth HDMI 1 HDMI 2	ARC / eARC OPT USB BT HDMI1 HDMI2
Bluetooth	Otsingurežiim (vilgub) Sidumisrežiim	BT PAIR
Helitugevuse reguleerimine	Helitugevuse tase Minimaalne helitugevus on saavutatud Maksimaalne helitugevus saavutatud Vaigista	V 36 MIN MAX MUTE
TASE	BASS (+/-) TREBLE (+/-) Ruumiline hääl (+/-) Dialoog Av Sync	BAS-S / BAS+S TRE-S / TRE+S SR-S / SR+S DIAL0 / DIAL6 SYNC
Helirežiimid	Standard/Häälmuusika/Film/Mäng/Sport	STANDARD VOICE MUSIC MOVIE GAME SPORT
Heliefekt	Bassivõim Surround Enhance Läbi pääsema Öö NEURALX DRC LED DIM	BASBST ON / BASBST OFF SURENH ON / SURENH OFF PASSTH ON / PASSTH OFF NIGHT ON / NIGHT OFF DTSNEU ON / DTSNEU OFF DTSBRC LOW / DTSBRC MID / DTSBRC HIGH DIM 1 / DIM 2 / DIM 3

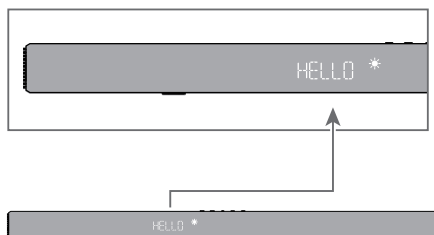

FI

	Äänipalkin tila	LED-näytön tila
Teho	Virta päälle Virta pois	HELLO STDBY / SLEEP
Lähde	HDMI eARC/ARC Optinen USB Bluetooth HDMI 1 HDMI 2	ARC / eARC OPT USB BT HDMI1 HDMI2
Bluetooth	Hakutila (vilkkuu) Pariliitostila	BT PAIR
Äänenvoimakkuuden säädin	Äänenvoimakkuuden taso Minimiäänenvoimakkuus saavutettu Suurin äänenvoimakkuus saavutettu Mykistä	V 36 MIN MAX MUTE
TASO	BASS (+/-) TREBLE (+/-) Surround-ääni (+/-) Dialogi Av Sync	BAS-S / BAS+S TRE-S / TRE+S SR-S / SR+S DIAL0 / DIAL6 SYNC
Äänitilat	Vakio/Puhe/Musiikki/Elokuva/ Peli/Urheilu	STANDARD VOICE MUSIC MOVIE GAME SPORT
Äänitehoste	Basson korostus Surround Enhance Kulkea läpi Yö NEURALX DRC LED DIM	BASBST ON / BASBST OFF SURENH ON / SURENH OFF PASSTH ON / PASSTH OFF NIGHT ON / NIGHT OFF DTSNEU ON / DTSNEU OFF DTSBRC LOW / DTSBRC MID / DTSBRC HIGH DIM 1 / DIM 2 / DIM 3

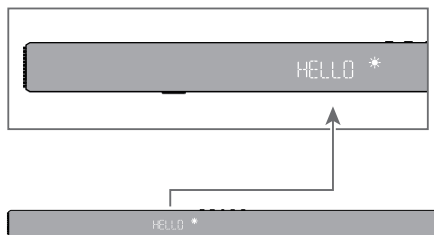

FR

	État de la barre de son	État d'affichage LED
Alimentation	Mise sous tension Mise hors tension	HELLO STDBY / SLEEP
Source	HDMI eARC/ARC Optique USB Bluetooth HDMI 1 HDMI 2	ARC / eARC OPT USB BT HDMI1 HDMI2
Bluetooth	Mode de recherche (clignotant) Mode d'appairage	BT PAIR
Contrôle du volume	Niveau de volume Volume minimal atteint Volume maximal atteint Muet	V 36 MIN MAX MUTE
Niveau	BASSE (+/-) AIGUS (+/-) Volume renforcé (+/-) Dialogue Sync Av	BAS-S / BAS+S TRE-S / TRE+S SR-S / SR+S DIAL0 / DIAL6 SYNC
Modes sonores	Standard/Voix/Musique/ Film/Jeu/Sports	STANDARD VOICE MUSIC MOVIE GAME SPORT
Effet sonore	Basse renforcée Surround renforcé Passer Nuit NEURALX DRC LED DIM	BASBST ON / BASBST OFF SURRENH ON / SURRENH OFF PASSTH ON / PASSTH OFF NIGHT ON / NIGHT OFF DTSNEU ON / DTSNEU OFF DTSBRC LOW / DTSBRC MID / DTSBRC HIGH DIM 1 / DIM 2 / DIM 3

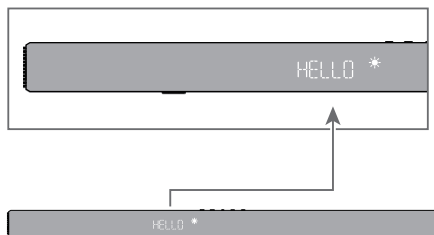

DE

	Soundbar-Status	LED-Anzeigestatus
Leistung	Ein Ausschalten	HELLO STDBY / SLEEP
Quelle	HDMI eARC/ARC Optisch USB Bluetooth HDMI 1 HDMI 2	ARC / eARC OPT USB BT HDMI1 HDMI2
Bluetooth	Suchmodus (blinkend) Verbindungsmodus	BT PAIR
Lautstärkeregelung	Lautstärke Mindestlautstärke erreicht Maximale Lautstärke erreicht Stumm	V 36 MIN MAX MUTE
EBEN	BASS (+/-) HÖHEN (+/-) Surround-Stimme (+/-) Dialog Av Sync	BAS-S / BAS+S TRE-S / TRE+S SR-S / SR+S DIAL0 / DIAL6 SYNC
Klangmodi	Standard/Sprache/Musik/- Film/ Spiel/Sport	STANDARD VOICE MUSIC MOVIE GAME SPORT
Sound-EFFEKT	Bass-Boost Surround-Verbesserung Durchgang Nacht NEURALX DRC	BASBST ON / BASBST OFF SURENH ON / SURENH OFF PASSTH ON / PASSTH OFF NIGHT ON / NIGHT OFF DTSNEU ON / DTSNEU OFF DTSBRC LOW / DTSBRC MID / DTSBRC HIGH
	LED DIM	DIM 1 / DIM 2 / DIM 3

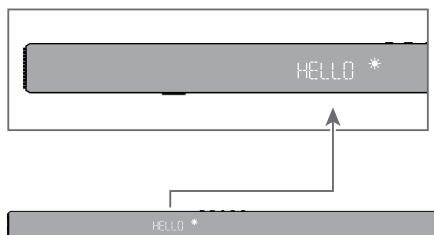

CS

	Κατάσταση Soundbar	Κατάσταση οθόνης LED
Εξουσία	Ενεργοποιήστε Απενεργοποίηση	HELLO STBY / SLEEP
Πηγή	HDMI eARC/ARC Οπτικός USB Bluetooth HDMI 1 HDMI 2	ARC / eARC OPT USB BT HDMI1 HDMI2
Bluetooth	Λειτουργία αναζήτησης (αναβοσβήνει) Λειτουργία ζεύξης	BT PAIR
Ελεγχος έντασης	Επίπεδο έντασης Συμπληρώθηκε η ελάχιστη ένταση Συμπληρώθηκε η μέγιστη ένταση Βουβός	V 36 MIN MAX MUTE
ΕΠΙΠΕΔΟ	ΜΠΑΣΟ (+/-) TREBLE (+/-) SurrVol (+/-) (+/-) Διάλογος An Sync	BAS-S / BAS+S TRE-S / TRE+S SR-S / SR+S DIALOG / DIALOG SYNC
Λειτουργίες ήχου	Τυπικό/Φωνή/Μουσική/Ταινί α/ Παιχνίδι/Αθλητικά	STANDARD VOICE MUSIC MOVIE GAME SPORT
Εφέ ήχου	Ενίσχυση μπάσου Ενίσχυση Surround Περνώ μέσα από Νύχτα NEURALX DRC LED DIM	BASBST ON / BASBST OFF SURRENH ON / SURRENH OFF PASSTH ON / PASSTH OFF NIGHT ON / NIGHT OFF DTSNEU ON / DTSNEU OFF DTSBRC LOW / DTSBRC MID / DTSBRC HIGH DIM 1 / DIM 2 / DIM 3

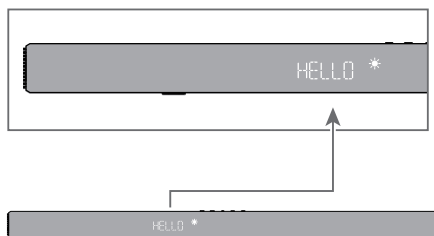

HU

	Hangsáv állapota	LED kijelző állapota
Erő	Bekapcsolás Kikapcsolni	HELLO STDBY / SLEEP
Forrás	HDMI eARC/ARC Optikai USB Bluetooth HDMI 1 HDMI 2	ARC / eARC OPT USB BT HDMI1 HDMI2
Bluetooth	Keresési mód (villog) Párosítási mód	BT PAIR
Hangerőszabályozó	Hangerőszint Elérte a minimális hangerőt Elérte a maximális hangerőt Néma	V 36 MIN MAX MUTE
SZINT	BASS (+/-) TREBLE (+/-) Térhatású hang (+/-) Párbeszéd Av Sync	BAS-S / BAS+S TRE-S / TRE+S SR-S / SR+S DIAL0 / DIAL6 SYNC
Hangmódok	Normál/Hang/Zene/Film/ Játék/Sport	STANDARD VOICE MUSIC MOVIE GAME SPORT
Hang EFFEKTUS	Bass Boost Térhangzás fokozása Átmegy Éjszaka NEURALX DRC	BASBST ON / BASBST OFF SURENH ON / SURENH OFF PASSTH ON / PASSTH OFF NIGHT ON / NIGHT OFF DTSNEU ON / DTSNEU OFF DTSBRC LOW / DTSBRC MID / DTSBRC HIGH
	LED DIM	DIM 1 / DIM 2 / DIM 3

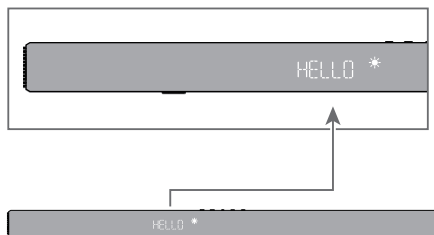

IT

HELLO *		
	Stato della barra audio	Stato del display a LED
Potenza	Accensione Spegni	HELLO STBY / SLEEP
Fonte	HDMI eARC/ARC Ottico USB Bluetooth HDMI 1 HDMI 2	ARC / eARC OPT USB BT HDMI1 HDMI2
Bluetooth	Modalità di ricerca (lampeggiante) Modalità di associazione	BT PAIR
Controllo del volume	Livello del volume Volume minimo raggiunto Volume massimo raggiunto Muto	V 36 MIN MAX MUTE
LIVELLO	BASSO (+/-) ALTI (+/-) SurrVol(+/-) Dialogo Av Sync	BAS-S / BAS+S TRE-S / TRE+S SR-S / SR+S DIAL0 / DIAL6 SYNC
Modalità audio	Standard/Voce/Musica/Film/ Giochi/Sport	STANDARD VOICE MUSIC MOVIE GAME SPORT
EFFETTO sonoro	Aumento dei bassi Migliora l'ambiente circostante Passante Notte NEURALX DRC LED DIM	BASDST ON / BASDST OFF SURENH ON / SURENH OFF PASSTH ON / PASSTH OFF NIGHT ON / NIGHT OFF DTSNEU ON / DTSNEU OFF DTSBRC LOW / DTSBRC MID / DTSBRC HIGH DIM 1 / DIM 2 / DIM 3

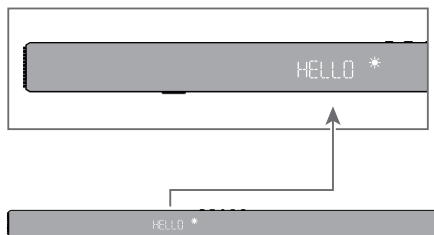

LV

	Skaņas joslas statuss	LED displeja statuss
Jauda	Ieslēdziet barošanu Izslēgt	HELLO STDBY / SLEEP
Avots	HDMI eARC/ARC Optiskais USB Bluetooth HDMI 1 HDMI 2	ARC / eARC OPT USB BT HDMI1 HDMI2
Bluetooth	Meklēšanas režīms (mirgo) Savienošanas pāri režīms	BT PAIR
Skaļuma kontrole	Skaļuma līmenis Sasniegts minimālais apjoms Sasniegts maksimālais skaļums Izslēgt skaņu	V 36 MIN MAX MUTE
LĪMENIS	BASS (+/-) TREBLE (+/-) Telpiskā balss (+/-) Dialogs Av Sync	BAS-S / BAS+S TRE-S / TRE+S SR-S / SR+S DIAL0 / DIAL6 SYNC
Skaņas režīmi	Standarta/Balss/Mūzika/Filma/ Spēle/Sports	STANDARD VOICE MUSIC MOVIE GAME SPORT
Skaņas EFEKTS	Bass Boost Telpiskās skaņas uzlabošana Iet cauri Nakts NEURALX DRC LED DIM	BASBST ON / BASBST OFF SURENH ON / SURENH OFF PASSTH ON / PASSTH OFF NIGHT ON / NIGHT OFF DTSNEU ON / DTSNEU OFF DTSBRC LOW / DTSBRC MID / DTSBRC HIGH DIM 1 / DIM 2 / DIM 3

3

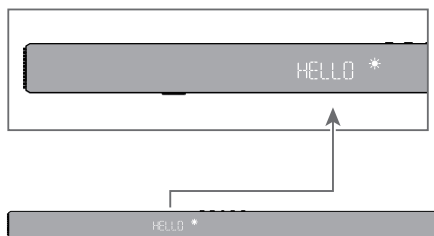

LT

	Garso juostos būseną	LED ekrano būseną
Galia	Maitinimas Išjungti	HELLO STDBY / SLEEP
Šaltinis	HDMI eARC/ARC Optinis USB Bluetooth HDMI 1 HDMI 2	ARC / eARC OPT USB BT HDMI1 HDMI2
Bluetooth	Paieškos režimas (mirksi) Poravimo režimas	BT PAIR
Garso valdymas	Garsumo lygis Pasiiektas minimalus tūris Pasiiektas maksimalus garsumas Nutildyti	V 36 MIN MAX MUTE
LYGIS	BASAS (+/-) TREBLE (+/-) Erdvinis balsas (+/-) Dialogas Av Sync	BAS-S / BAS+S TRE-S / TRE+S SR-S / SR+S DIALOG / DIALOG SYNC
Garso režimai	Standartinis/Balsas/Muzika/- Filmas/ Žaidimas/Sportas	STANDARD VOICE MUSIC MOVIE GAME SPORT
Garso EFEKTAS	Bass Boost Erdvinio garso stiprinimas Pereiti Naktis NEURALX DRC	BASBOOST ON / BASBOOST OFF SURENH ON / SURENH OFF PASSTH ON / PASSTH OFF NIGHT ON / NIGHT OFF DTSNEU ON / DTSNEU OFF DTSBRC LOW / DTSBRC MID / DTSBRC HIGH
	LED DIM	DIM 1 / DIM 2 / DIM 3

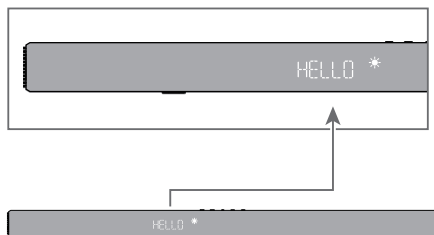

МК

	Статус на лентата за звук	Статус на LED дисплеј
Ноќ	Вклучете го Исклучете го	HELLO STDBY / SLEEP
Извор	HDMI eARC/ARC Оптички USB Bluetooth HDMI 1 HDMI 2	ARC / eARC OPT USB BT HDMI1 HDMI2
Bluetooth	Режим на пребарување (трепка) Режим на спарување	BT PAIR
Контрола на јачината на звукот	Ниво на гласност Достигнат е минимален волумен Достигнат е максимален волумен Исклучи звук	V 36 MIN MAX MUTE
НИВО	BAS (+/-) TREBLE (+/-) Сараунд глас (+/-) Дијалог Av Sync	BAS-S / BAS+S TRE-S / TRE+S SR-S / SR+S DIALOG / DIALOG SYNC
Режими на звук	Стандарден/Глас/Музика/Филм/ Игра/Спорт	STANDARD VOICE MUSIC MOVIE GAME SPORT
Звучен ефект	Засилување на басот Подобрување на опкружувачки звук Премин Ноќ NEURALX DRC LED DIM	BASBST ON / BASBST OFF SURENH ON / SURENH OFF PASSTH ON / PASSTH OFF NIGHT ON / NIGHT OFF DTSNEU ON / DTSNEU OFF DTSBRC LOW / DTSBRC MID / DTSBRC HIGH DIM 1 / DIM 2 / DIM 3

3

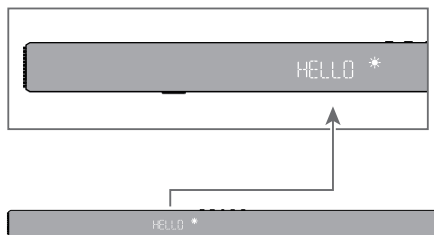

NO

	Soundbar Status	LED-skjermstatus
Makt	Strøm på Slå av	HELLO STDBY / SLEEP
Kilde	HDMI eARC/ARC Optisk USB Bluetooth HDMI 1 HDMI 2	ARC / eARC OPT USB BT HDMI1 HDMI2
Bluetooth	Søkemodus (blinker) Paringsmodus	BT PAIR
Volumkontroll	Volumnivå Minimumsvolum nådd Maksimalt volum nådd Stum	V 36 MIN MAX MUTE
NIVÅ	BASS (+/-) DISKANT (+/-) SurrVol (+/-) (+/-) Dialog Av Sync	BAS-S / BAS+S TRE-S / TRE+S SR-S / SR+S DIAL0 / DIAL6 SYNC
Lydmoduser	Standard/Stemme/Musikk/- Film/Spill/Sport	STANDARD VOICE MUSIC MOVIE GAME SPORT
Lyd EFFEKT	Bass Boost Surround Enhance Gå gjennom Natt NEURALX DRC LED DIM	BASBST ON / BASBST OFF SURENH ON / SURENH OFF PASSTH ON / PASSTH OFF NIGHT ON / NIGHT OFF DTSNEU ON / DTSNEU OFF DTSBRC LOW / DTSBRC MID / DTSBRC HIGH DIM 1 / DIM 2 / DIM 3

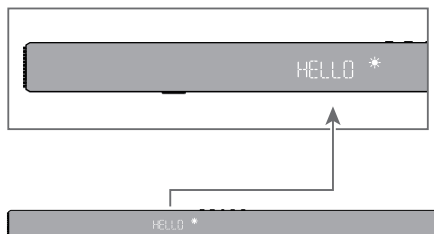

PL

	Stan listwy dźwiękowej	Stan wyświetlacza LED
Moc	Zasilanie włączone Wyłącz zasilanie	HELLO STDBY / SLEEP
Źródło	HDMI eARC/ARC Optyczny USB Bluetooth HDMI 1 HDMI 2	ARC / eARC OPT USB BT HDMI1 HDMI2
Bluetooth	Tryb wyszukiwania (miga) Tryb parowania	BT PAIR
Kontrola głośności	Poziom głośności Osiągnięto minimalną głośność Osiągnięto maksymalną głośność Niemy	V 36 MIN MAX MUTE
POZIOM	BAS (+/-) GÓRNY (+/-) Dźwięk przestrzenny (+/-) Dialog Av Sync	BAS-S / BAS+S TRE-S / TRE+S SR-S / SR+S DIALOG / DIALOG SYNC
Tryby dźwięku	Standardowy/Głos/Muzyka/- Film/ Gra/Sport	STANDARD VOICE MUSIC MOVIE GAME SPORT
EFEKT dźwiękowy	Wzmocnienie basów Wzmocnienie dźwięku przestrzennego Przejsć przez Noc NEURALX DRC	BASBST ON / BASBST OFF SURENH ON / SURENH OFF PASSSTH ON / PASSSTH OFF NIGHT ON / NIGHT OFF DTSNEU ON / DTSNEU OFF DTSBRC LOW / DTSBRC MID / DTSBRC HIGH
	LED DIM	DIM 1 / DIM 2 / DIM 3

3

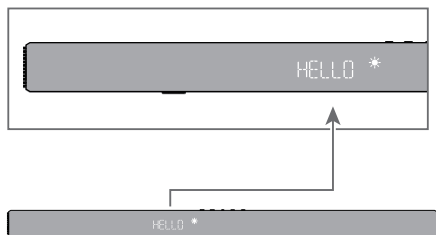

PT

	Estado da barra de som	Estado do visor LED
Energia	Ligar Desligar a energia	HELLO STBY / SLEEP
Fonte	HDMI eARC/ARC Óptica USB Bluetooth HDMI 1 HDMI 2	ARC / eARC OPT USB BT HDMI1 HDMI2
Bluetooth	Modo de pesquisa (intermitente) Modo de emparelhamento	BT PAIR
Controlo de volume	Nível de volume Volume mínimo atingido Volume máximo atingido Mudo	V 36 MIN MAX MUTE
NÍVEL	BASS (+/-) TREBLE (+/-) SurrVol (+/-) Diálogo Av Sync	BAS-S / BAS+S TRE-S / TRE+S SR-S / SR+S DIAL0 / DIAL6 SYNC
Modos de som	Standard/Voz/Música/Movie/ Jogo/Desporto	STANDARD VOICE MUSIC MOVIE GAME SPORT
Som EFEITO	BassBoost SurrEnhan Passé Throu Noite NEURALX RDC LED DIM	BASBST ON / BASBST OFF SURRENH ON / SURRENH OFF PASSSTH ON / PASSSTH OFF NIGHT ON / NIGHT OFF DTSNEU ON / DTSNEU OFF DTSBRC LOW / DTSBRC MID / DTSBRC HIGH DIM 1 / DIM 2 / DIM 3

3

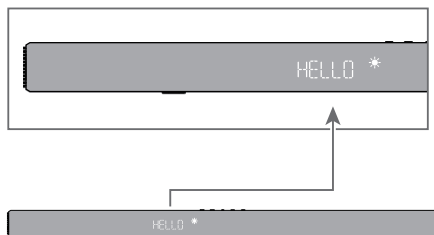

RO

	Stare bară de sunet	Stare afișaj LED
Putere	Aprinde Oprește	HELLO STBY / SLEEP
Sursă	HDMI eARC/ARC Optic USB Bluetooth HDMI 1 HDMI 2	ARC / eARC OPT USB BT HDMI1 HDMI2
Bluetooth	Modul de căutare (intermitent) Modul de asociere	BT PAIR
Controlul volumului	Nivelul volumului Volumul minim atins Volumul maxim atins Mut	V 36 MIN MAX MUTE
NIVEL	BASS (+/-) TREBLE (+/-) SurrVol(+/-) Dialog Av Sync	BAS-S / BAS+S TRE-S / TRE+S SR-S / SR+S DIAL0 / DIAL6 SYNC
Moduri de sunet	Standard/Voce/Muzică/Film/Joc/Sport	STANDARD VOICE MUSIC MOVIE GAME SPORT
EFFECT sonor	Bass Boost Surround Enhance A trece prin Noapte NEURALX DRC LED DIM	BASBST ON / BASBST OFF SURENH ON / SURENH OFF PASSTH ON / PASSTH OFF NIGHT ON / NIGHT OFF DTSNEU ON / DTSNEU OFF DTSBRC LOW / DTSBRC MID / DTSBRC HIGH DIM 1 / DIM 2 / DIM 3

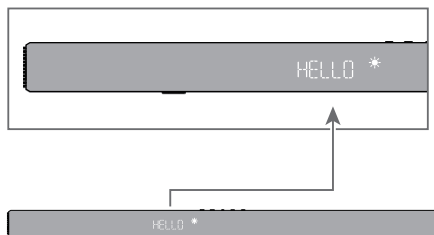

RU

	Состояние саундбара	Состояние светодиодного дисплея
Источник питания	Питание включено	HELLO
	Питание выключено	STDBY / SLEEP
Источник	HDMI eARC/ARC	ARC / eARC
	Оптический	OPT
	USB	USB
	Bluetooth	BT
	HDMI 1	HDMI1
	HDMI 2	HDMI2
Bluetooth	Режим поиска (мигающий)	BT
	Режим сопряжения	PAIR
Регулировка громкости	Уровень громкости	V 36
	Достигнут минимальная громкость	MIN
	Достигнут максимальная громкость	MAX
	Отключение звука	MUTE
УРОВЕНЬ	БАС (+/-)	BAS-S / BAS+S
	ВЕРХИ (+/-)	TRE-S / TRE+S
	Объемное звучание (+/-)	SR-S / SR+S
	Диалог	DIALOG / DIALOG
	Средняя синхронизация	SYNC
Звуковые режимы	Стандарт/Голос/Музыка/ Кино/Игра/Спорт	STANDARD VOICE MUSIC MOVIE GAME SPORT
	Звуковой эффект	
Звуковой эффект	Усиление басов	BASBST ON / BASBST OFF
	Усиление объемного звучания	SURENH ON / SURENH OFF
	Пройти через	PASSTH ON / PASSTH OFF
	Ночь	NIGHT ON / NIGHT OFF
	NEURAL X	DTSNEU ON / DTSNEU OFF
	DRC	DTSBRC LOW / DTSBRC MID / DTSBRC HIGH
	Тусклость светодиода	DIM 1 / DIM 2 / DIM 3

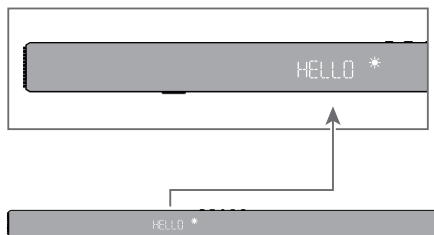

SR

	Status zvučne trake	Status LED prikaza
Mož	Napajanje je na Isključeno napajanje	HELLO STBY / SLEEP
Izvor	HDMI eARC/ARC Optički USB Bluetooth HDMI 1 HDMI 2	ARC / eARC OPT USB BT HDMI1 HDMI2
Bluetooth	Režim pretrage (treperenje) Režim uparivanja	BT PAIR
Kontrola jačine zvuka	Nivo jačine zvuka Dostignuta minimalna jačina zvuka Dostignuta maksimalna jačina zvuka Nem	V 36 MIN MAX MUTE
NIVO	BAS (+/-) TREBLE (+/-) SurrVol (+/-) (+/-) Dijalog Av Sync	BAS-S / BAS+S TRE-S / TRE+S SR-S / SR+S DIALOG / DIALOG SYNC
Režimi zvuka	Standardno/Glas/Muzika/- Film/Igra/Sport	STANDARD VOICE MUSIC MOVIE GAME SPORT
EFEKAT zvuka	Bas Boost Surround Enhance Prolaz Noć NEURALX DRC LED DIM	BASBOOST ON / BASBOOST OFF SURRENH ON / SURRENH OFF PASSTH ON / PASSTH OFF NIGHT ON / NIGHT OFF DTSNEU ON / DTSNEU OFF DTSBRC LOW / DTSBRC MID / DTSBRC HIGH DIM 1 / DIM 2 / DIM 3

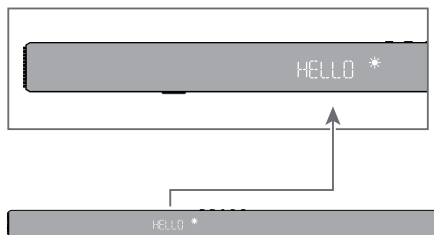

SK

	Stav zvukového panela	Stav LED displeja
Moc	Zapnutie Vypnúť	HELLO STDBY / SLEEP
Zdroj	HDMI eARC/ARC Optické USB Bluetooth HDMI 1 HDMI 2	ARC / eARC OPT USB BT HDMI1 HDMI2
Bluetooth	Režim vyhľadávania (bliká) Režim párovania	BT PAIR
Nastavenie hlasitosti	Úroveň hlasitosti Dosiahnutá minimálna hlasitosť Bola dosiahnutá maximálna hlasitosť Stlmiť	V 36 MIN MAX MUTE
LEVEL	BASS (+/-) VÝŠKY (+/-) Priestorový hlas (+/-) Dialóg Av Sync	BAS-5 / BAS+5 TRE-5 / TRE+5 SR-5 / SR+5 DIALOG / DIALOG SYNC
Zvukové režimy	Štandardné/Hlas/Hudba/- Film/ Hra/Šport	STANDARD VOICE MUSIC MOVIE GAME SPORT
Zvukový EFEKT	Zvýraznenie basov Surround Enhance Prejsť cez Noc NEURALX DRC LED DIM	BASBST ON / BASBST OFF SURENH ON / SURENH OFF PASSSTH ON / PASSSTH OFF NIGHT ON / NIGHT OFF DTSNEU ON / DTSNEU OFF DTSBRC LOW / DTSBRC MID / DTSBRC HIGH DIM 1 / DIM 2 / DIM 3

3

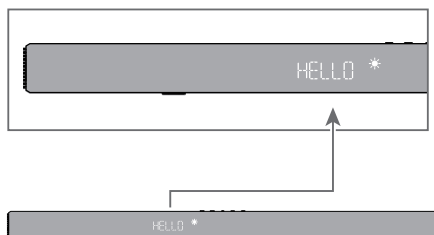

SL

HELLO *		
	Stanje zvočne vrstice	Status LED zaslona
Moč	Vklop Ugasniti	HELLO STDBY / SLEEP
Vir	HDMI eARC/ARC Optični USB Bluetooth HDMI 1 HDMI 2	ARC / eARC OPT USB BT HDMI1 HDMI2
Bluetooth	Način iskanja (utripa) Način seznanjanja	BT PAIR
Nadzor glasnosti	Raven glasnosti Dosežena minimalna glasnost Dosežena je največja glasnost Izklopi zvok	V 3G MIN MAX MUTE
RAVEN	BASS (+/-) VISOKI (+/-) Prostorski glas (+/-) dialog Av Sync	BAS-S / BAS+S TRE-S / TRE+S SR-S / SR+S DIALOG / DIALOG SYNC
Zvočni načini	Standardno/Glas/Glasba/- Film/ Igra/šport	STANDARD VOICE MUSIC MOVIE GAME SPORT
Zvočni EFEKT	Ojačenje nizkih tonov Izboljšanje prostorskega zvoka lti skozi noč NEURALX DRC LED DIM	BASBST ON / BASBST OFF SURENH ON / SURENH OFF PASTH ON / PASTH OFF NIGHT ON / NIGHT OFF DTSNEU ON / DTSNEU OFF DTSBRC LOW / DTSBRC MID / DTSBRC HIGH DIM 1 / DIM 2 / DIM 3

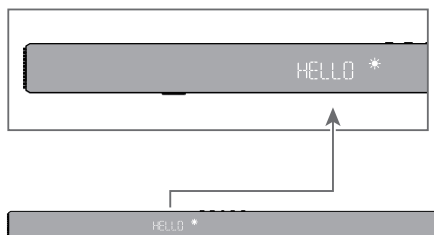

ES

		HELLO *
	Estado de la Barra de Sonido	Estado de Visualización de LED
Alimentación	Encendido Apagado	HELLO STDBY / SLEEP
Fuente	HDMI eARC/ARC Óptico USB Bluetooth HDMI 1 HDMI 2	ARC / eARC OPT USB BT HDMI1 HDMI2
Bluetooth	Modo de búsqueda (intermitente) Modo de emparejamiento	BT PAIR
Control del volumen	Nivel de volumen Volumen mínimo alcanzado Volumen máximo alcanzado Silencio	V 36 MIN MAX MUTE
NIVEL	GRAVES (+/-) AGUDOS (+/-) Volumen Envoltente (+/-) Diálogo Sincronización Av	DRG-S / DRG+S TRE-S / TRE+S SR-S / SR+S DIALOG / DIALOG SYNC
Modos de sonido	Estándar/Voz/Música/Películas/Juegos/Deportes	STANDARD VOICE MUSIC MOVIE GAME SPORT
Efecto de sonido	Refuerzo de Graves Refuerzo de Envoltente Pass Throu Noche NEURALX DRC LED DIM	DRSDBT ON / DRSDBT OFF SURENH ON / SURENH OFF PASSSTH ON / PASSSTH OFF NIGHT ON / NIGHT OFF DTSNEU ON / DTSNEU OFF DTSBRC LOW / DTSBRC MID / DTSBRC HIGH DIM 1 / DIM 2 / DIM 3

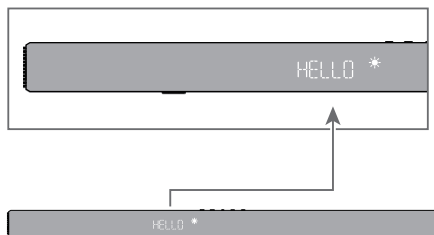

SV

	Soundbar Status	LED-displaystatus
Kraft	Ström på Stäng av	HELLO STDBY / SLEEP
Källa	HDMI eARC/ARC Optisk USB Bluetooth HDMI 1 HDMI 2	ARC / eARC OPT USB BT HDMI1 HDMI2
Bluetooth	Sökläge (blinkande) Parningsläge	BT PAIR
Volymkontroll	Volymnivå Minsta volym uppnådd Maximal volym uppnådd Stum	V 36 MIN MAX MUTE
NIVÅ	BAS (+/-) TREBLE (+/-) Surroundljud (+/-) Dialog Av Sync	BAS-S / BAS+S TRE-S / TRE+S SR-S / SR+S DIALOG / DIALOG SYNC
Ljudlägen	Standard/Röst/Musik/Film/ Spel/Sport	STANDARD VOICE MUSIC MOVIE GAME SPORT
Ljudeffekt	Basförstärkning Surround Enhance Passera genom Natt NEURALX DRC LED DIM	BASBST ON / BASBST OFF SURENH ON / SURENH OFF PASSSTH ON / PASSSTH OFF NIGHT ON / NIGHT OFF DTSNEU ON / DTSNEU OFF DTSBRC LOW / DTSBRC MID / DTSBRC HIGH DIM 1 / DIM 2 / DIM 3

3

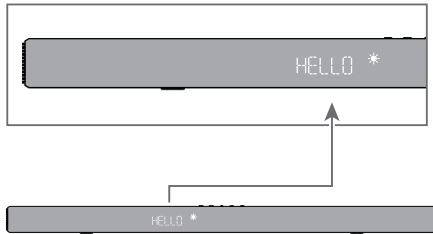

TR

HELLO *		
	Ses Çubuğu Durumu	LED Ekran Durumu
Güç	Açık Kapat	HELLO STDBY / SLEEP
Kaynak	HDMI eARC/ARC Optik USB Bluetooth HDMI 1 HDMI 2	ARC / eARC OPT USB BT HDMI1 HDMI2
Bluetooth	Arama modu (yanıp sönen) Eşleştirme modu	BT PAIR
Ses kontrol	ses seviyesi Minimum hacme ulaşıldı Maksimum hacme ulaşıldı Sesini kapatmak	V 36 MIN MAX MUTE
SEVIYE	BAS (+/-) TİZ (+/-) Çevresel Ses (+/-) Diyalog Av Sync	BAS-S / BAS+S TIZ-S / TIZ+S SR-S / SR+S DIALOG / DIALOG SYNC
Ses modları	Standart/Ses/Müzik/Film/ Oyun/Spor	STANDARD VOICE MUSIC MOVIE GAME SPORT
Ses EFEKTI	Bas Kuvvetlendirme Çevre Geliştirme Geçiş Gece NEURALX DRC LED DIM	BASDST ON / BASDST OFF SURENH ON / SURENH OFF PASSTH ON / PASSTH OFF NIGHT ON / NIGHT OFF DTSNEU ON / DTSNEU OFF DTSBRC LOW / DTSBRC MID / DTSBRC HIGH DIM 1 / DIM 2 / DIM 3

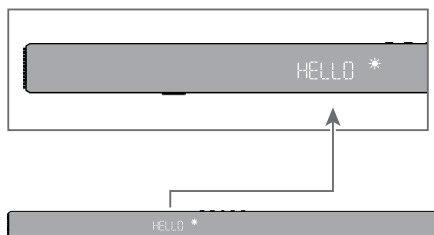

UA

	Стан звукової панелі	Статус світлодіодного дисплея
Потужність	Увімкніть живлення Вимкніть живлення	HELLO STBY / SLEEP
Джерело	HDMI eARC/ARC Оптичний USB Bluetooth HDMI 1 HDMI 2	ARC / eARC OPT USB BT HDMI1 HDMI2
Bluetooth	Режим пошуку (блимає) Режим створення пари	BT PAIR
Регулювання гучності	Рівень гучності Досягнутий мінімальний обсяг Досягнуто максимального обсягу Вимкнути звук	V 36 MIN MAX MUTE
РІВЕНЬ	BASS (+/-) B4 (+/-) Об'ємний голос (+/-) Діалог Av Sync	BAS-S / BAS+S TRE-S / TRE+S SR-S / SR+S DIAL0 / DIAL6 SYNC
Режими звуку	Стандартний/Голос/Музика /Фільм/ Гра/Спорт	STANDARD VOICE MUSIC MOVIE GAME SPORT
Звуковий ефект	Підсилення басів Покращення об'ємного звучання Проходить Ніч NEURALX DRC LED DIM	BASBST ON / BASBST OFF SURENH ON / SURENH OFF PASSTH ON / PASSTH OFF NIGHT ON / NIGHT OFF DTSNEU ON / DTSNEU OFF DTSBRC LOW / DTSBRC MID / DTSBRC HIGH DIM 1 / DIM 2 / DIM 3

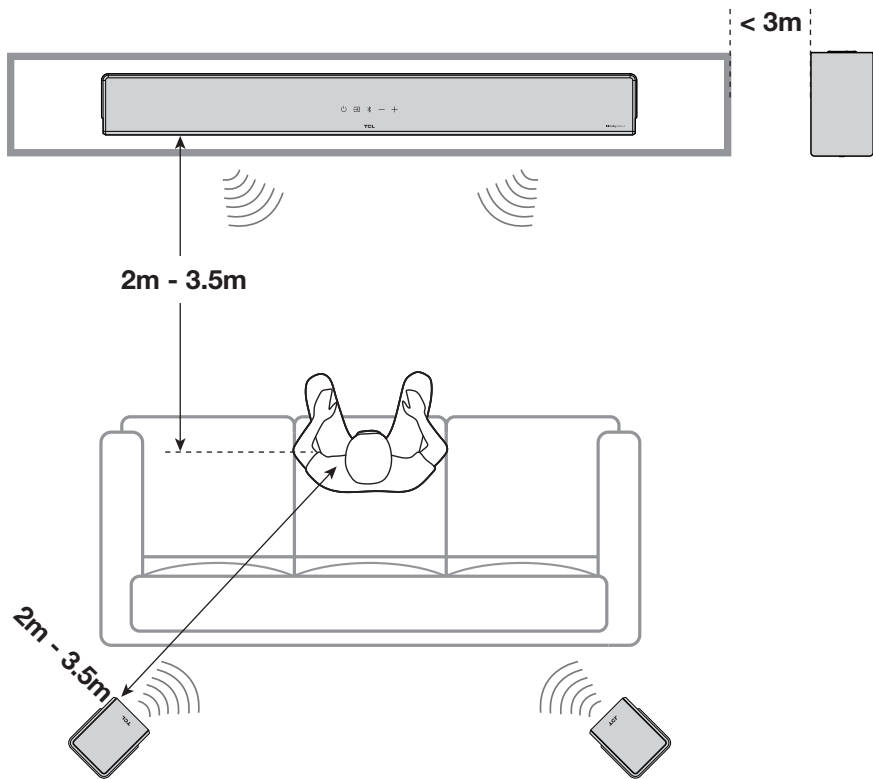

5a



L

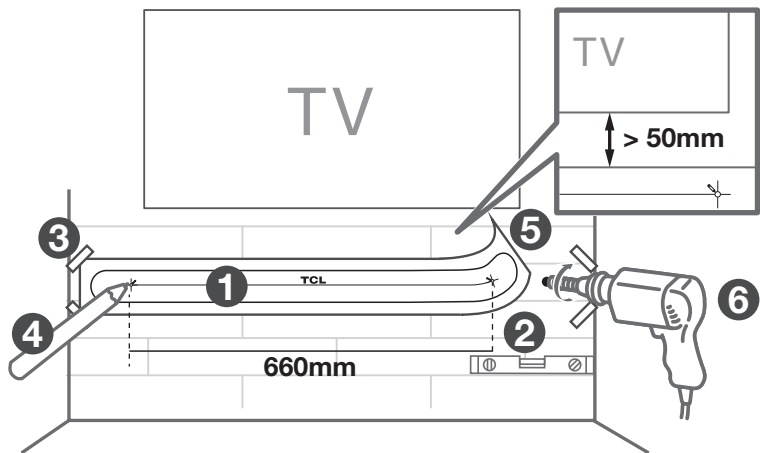
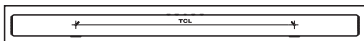

5b



H

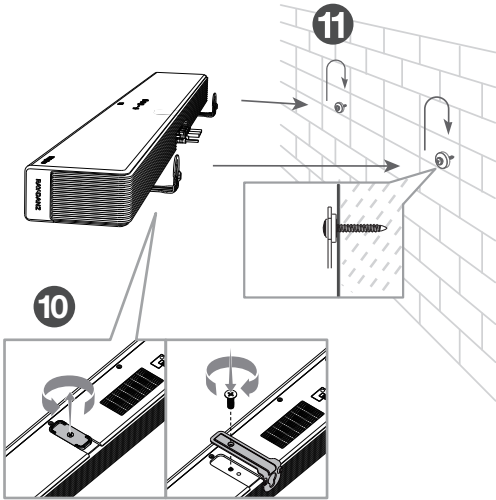
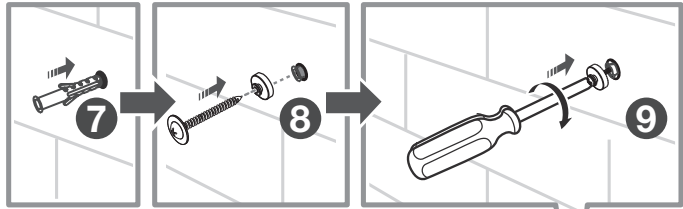
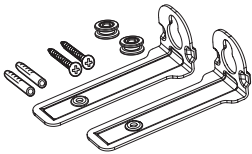

12

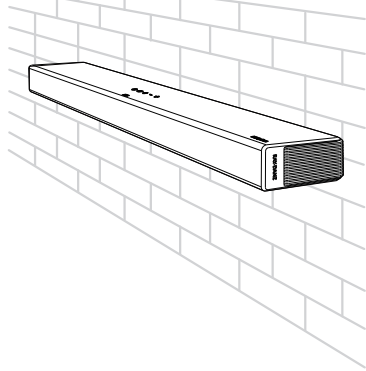

5c



I

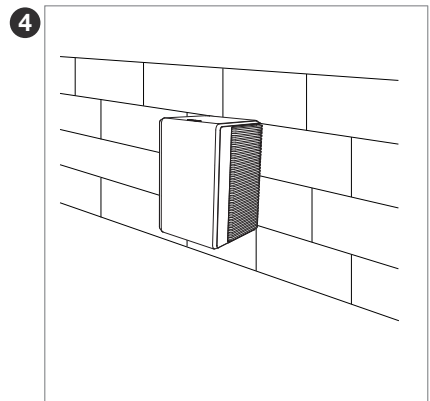
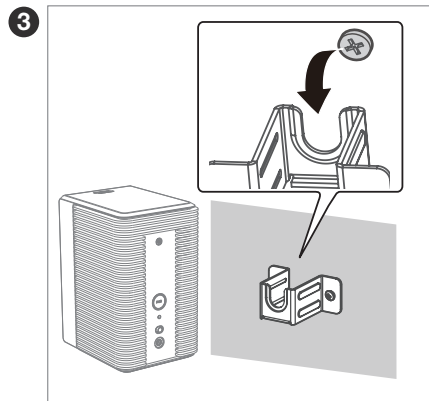
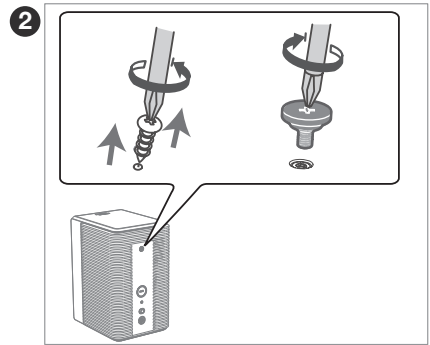
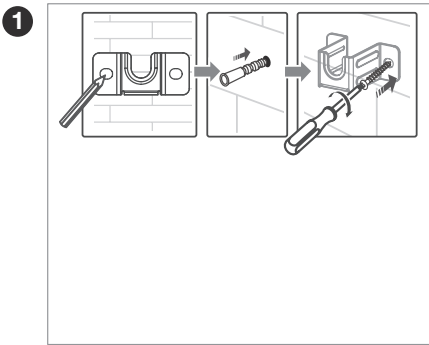

6a



Battery type: 1.5V AAA battery x 2

G

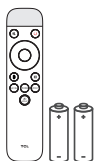

Warning: Do not expose batteries to excessive heat such as sunshine, fire, or the like. Keep new and used batteries away from children. For disposal or recycling information, please contact your local authorities.



CAUTION: Danger of explosion if the battery is incorrectly replaced. Replace only with the same or equivalent type.

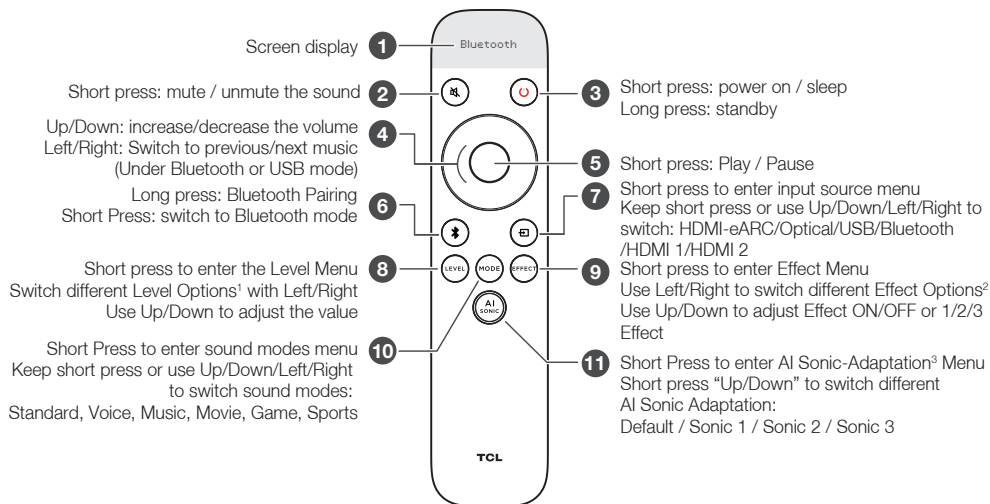
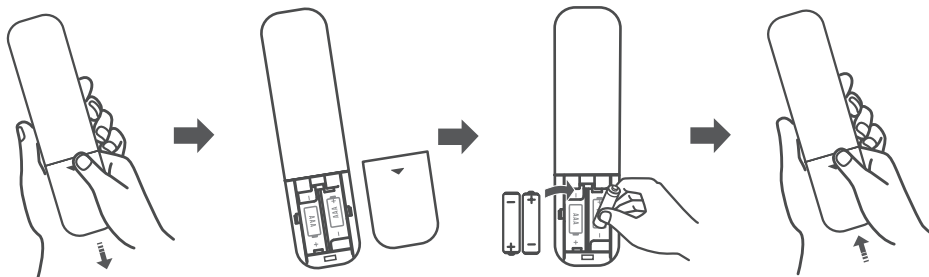

1. Level Options: Bass, Treble, Dialogue, SurrVol, Av Sync.

2. Effect Options: Bass Boost, Surround Enhance, Pass through, Night, NEURALX, DRC, LED Dim.

3. AI-Sonic Adaptation: Learn more in Section 8.

Note:

Factory Mode: Long Press Mode+Mute together for 5 seconds.

6a

SQ



Lloji i baterive: x 2 bateri 1.5V AAA

G

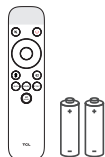

Paralajmërim: Mos i ekspozoni bateritë ndaj nxehtësisë së tepërt si rrezet e diellit, zjarri apo të ngjashme. Mbajini bateritë e reja dhe ato të përdorura larg fëmijëve. Për informacione në lidhje me asgjësimin ose riciklimin, ju lutemi kontaktoni autoritetet tuaja lokale.



KUJDES: Rrezik shpërthimi nëse bateria zëvendësohet në mënyrë të gabuar. Zëvendësimi të bëhet vetëm me të njëjtin lloj baterie ose ekuivalent.

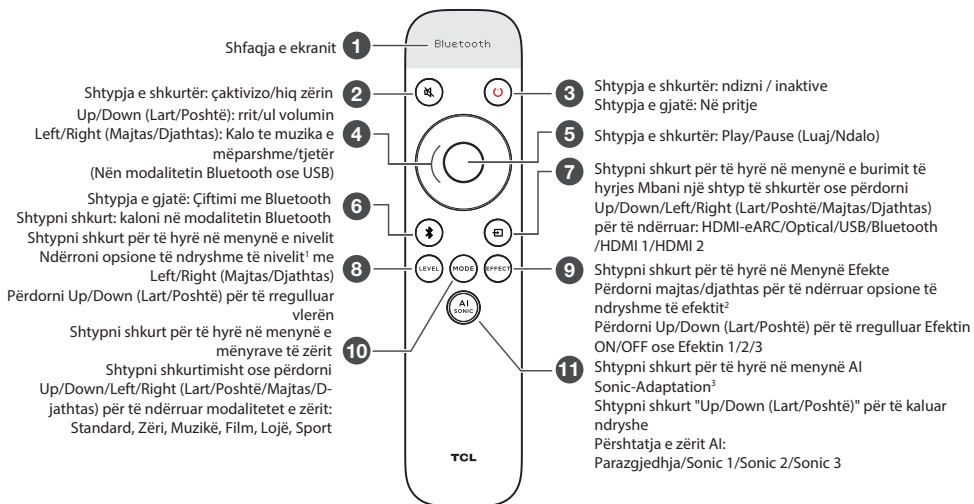
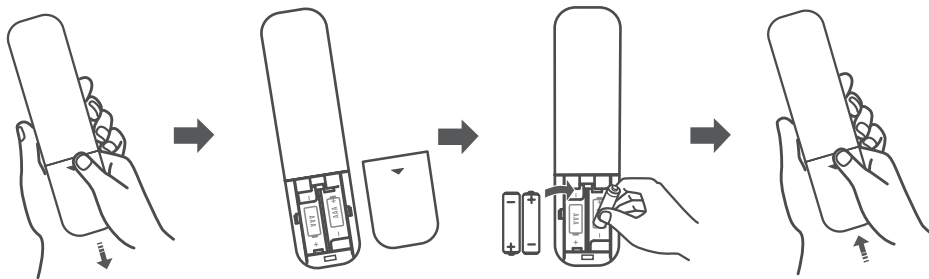

1. Opsionet e nivelit: Bass, Treble, Dialogue, Surr/Vol, Av Sync.

2. Opsionet e efektit: Bass Boost, Surround Enhance, Pass through, Night, NEURALX, DRC, LED Dim.

3. Përshtatja AI-Sonic: Mësoni më shumë në seksionin 8.

Shënim:

Modaliteti i fabrikës: Modaliteti i shtypjes së Mode+Mute (Gjatë + Heshtja) për 5 sekonda njëkohësisht

6a

BG



Тип батерия: Батерия 1.5V AAA x 2

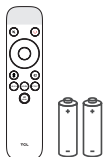

Предупреждение: Не излагайте батериите на интензивни източници на топлина, като например слънчева светлина, огън или други подобни. Съхранявайте новите и използваните батерии далеч от деца. Обърнете се към местните власти относно информация за изхвърляне или рециклиране.



ВНИМАНИЕ: Опасност от експлозия при неправилно поставяне на батерията. Подменете само със същата или еквивалент.

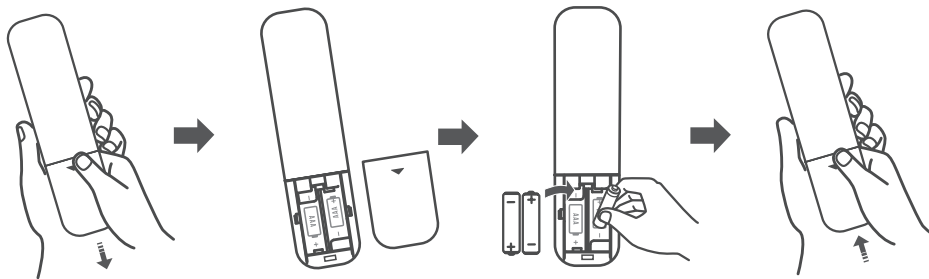

1. Опции за ниво: Bass, Treble, Dialogue, SurrVol, Av Sync.

2. Опции за ефект: Bass Boost, Surround Enhance, Pass through, Night, NEURALX, DRC, LED Dim.

3. AI-Sonic адаптация: Научете повече в Раздел 8.

Забележка:

Натиснете продължително Mode+Mute (Режим + Заглушаване) заедно за 5 секунди.



Tip baterije: 1,5V AAA baterija x 2

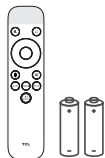

! Upozorenje: Ne izlažite baterije prekomjernoj toplini, poput sunčeve svjetlosti, vatre ili slično. Nove i rabljene baterije držite podalje od djece. Za informacije o odlaganju ili recikliranju obratite se lokalnim vlastima.

! OPREZ: Opasnost od eksplozije ako se baterija nepravilno zamijeni. Zamijenite samo istim ili ekvivalentnim tipom.

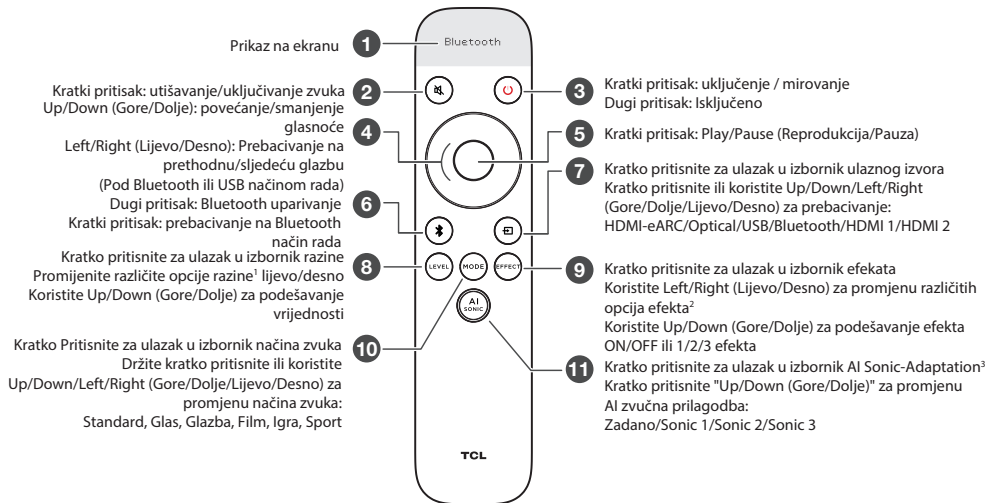
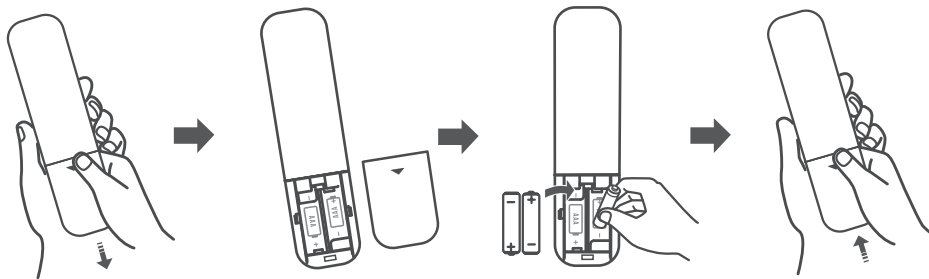

1. Opcije razine: Bass, Treble, Dialogue, SurrVol, Av Sync.

2. Opcije efekta: Bass Boost, Surround Enhance, Pass through, Night, NEURALX, DRC, LED Dim.

3. AI-Sonic adaptacija: Saznajte više u odjeljku 8.

Bilješka:

Tvornički način rada: Dugi pritisak zajedno na Mode+Mute (Način rada+Isključivanje zvuka) u trajanju od 5 sekundi

6a

CS



Typ baterie: 1.5V AAA baterie x 2

G

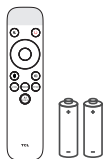

! Varování: Nevystavujte baterie nadměrnému teplu, jako je sluneční svit, oheň nebo podobně. Nové a použité baterie uchovávejte mimo dosah dětí. Obratě se na místní úřady pro informace o likvidaci nebo recyklaci.

! POZOR: Pokud je baterie nesprávně vyměněna, hrozí nebezpečí výbuchu. Nahraďte pouze stejným nebo rovnocenným typem.

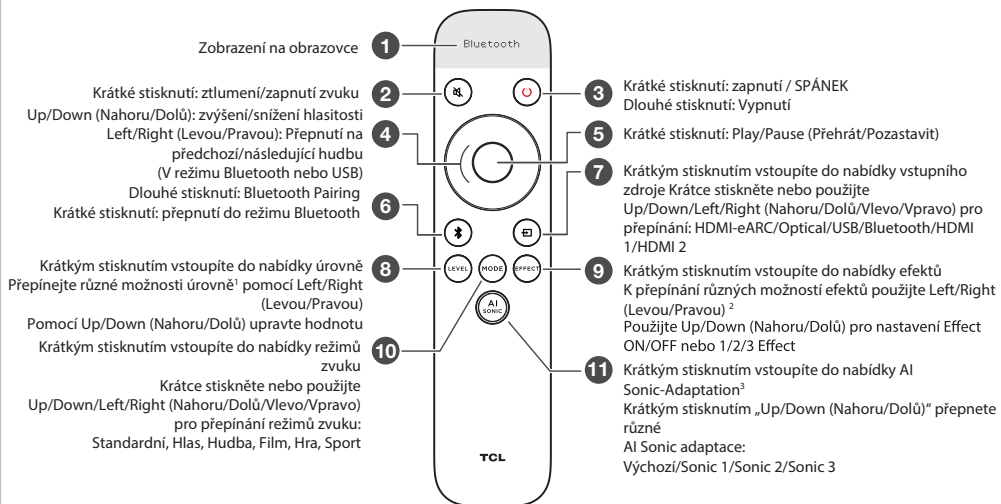
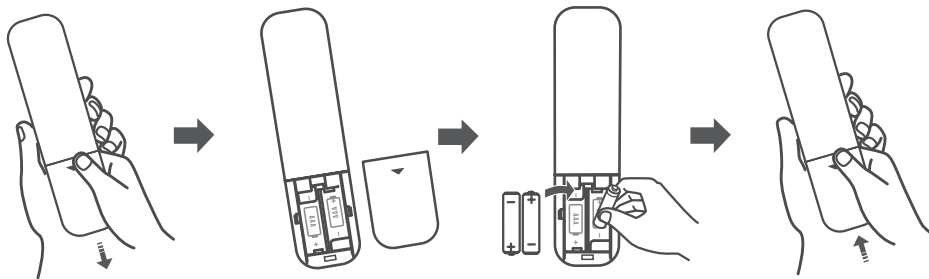

1. Možnosti úrovně: Bass, Treble, Dialogue, SurrVol, Av Sync.

2. Možnosti efektů: Bass Boost, Surround Enhance, Pass through, Night, NEURALX, DRC, LED Dim.

3. Adaptace AI-Sonic: Další informace naleznete v části 8.

Poznámka:

Tovární režim: Dlouze stisknete Mode+Mute (Ztlumení+Režim) společne po dobu 5 sekund.

6a



Batteri type: 1.5V AAA batteri x 2

G

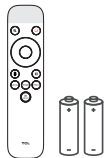

! Advarsel: Udsæt ikke batterier for overdreven varme som solskin, ild eller lignende. Hold nye og brugte batterier væk fra børn. Kontakt de lokale myndigheder for at få oplysninger om bortskaffelse eller genanvendelse.

! FORSIGTIG: Hvis batteriet udskiftes forkert, er der eksplosionsrisiko. Udskift kun med den samme eller tilsvarende type.

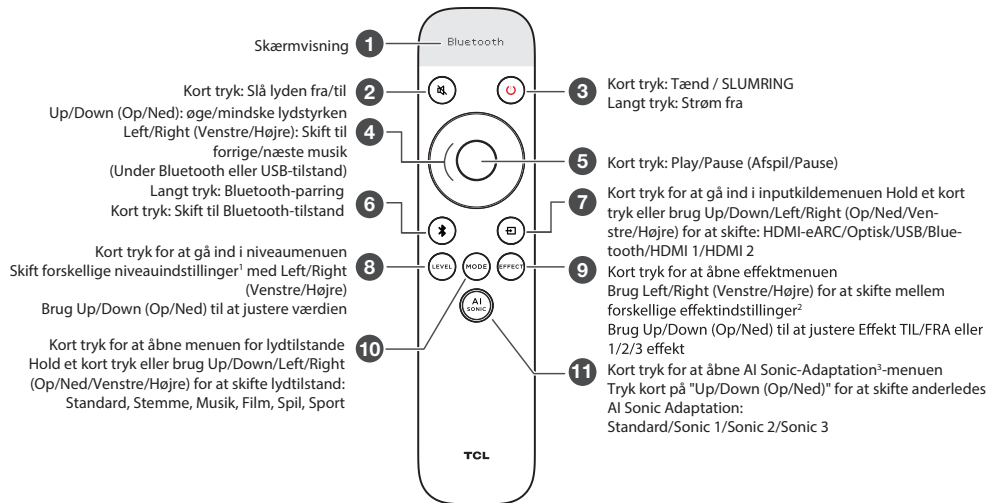
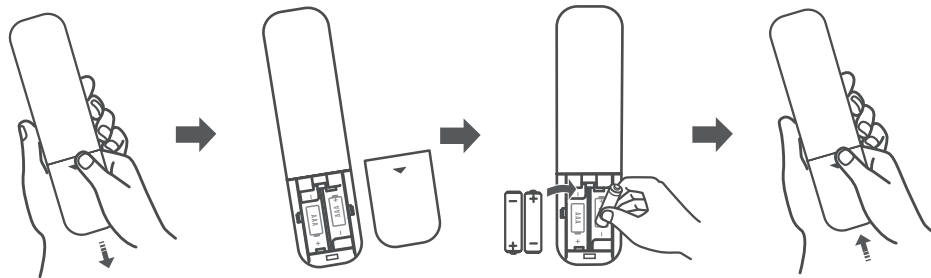

1. Niveauintstillinger: Bass, Treble, Dialogue, SurrVol, Av Sync.

2. Effektmuligheder: Bass Boost, Surround Enhance, Pass through, Night, NEURALX, DRC, LED Dim.

3. AI-Sonic-tilpasning: Lær mere i afsnit 8.

Bemærk:

Fabrikstilstand: Langt tryk mode+mute (tilstand+stum) i 5 sekunder samtidigt

6a



Batterij: 1,5V AAA-batterij x 2

G

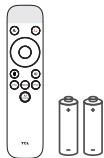

Waarschuwing: Stel batterijen NIET bloot aan extreme hitte zoals zonlicht, brand e.d. Houd nieuwe en oude batterijen buiten het bereik van kinderen. Neem contact op met uw gemeente voor informatie over het weggoaien en recyclen.



LET OP: Er is kans op een explosie als de batterijen verkeerd wordt geplaatst! Alleen vervangen door hetzelfde of equivalent type.

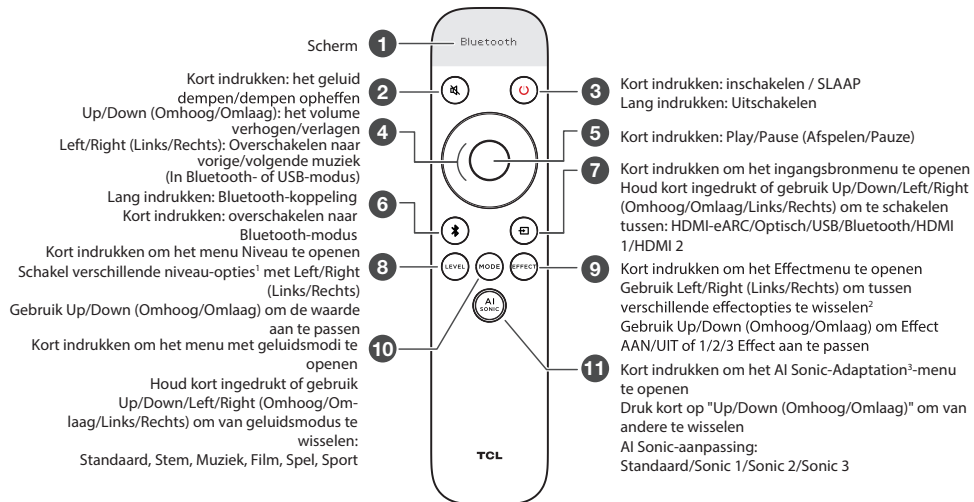
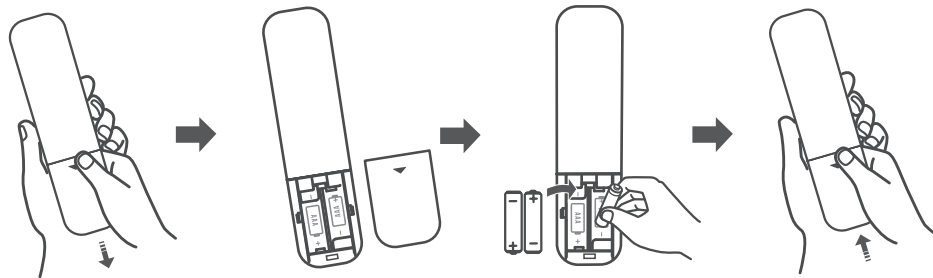

1. Niveau-opties: Bass, Treble, Dialogue, SurrVol, Av Sync.

2. Effectopties: Bass Boost, Surround Enhance, Pass through, Night, NEURALX, DRC, LED Dim.

3. AI-Sonic-aanpassing: lees meer in sectie 8.

Opmerking:

Fabrieksmodus: Druk Mode+Mute (Modus+Dempen) 5 seconden tegelijkertijd in.



Aku tüüp: 1.5V AAA aku x 2

G

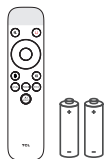

Hoiatus: Ärge jätke akusid liigse kuumuse (nt päikesevalguse, tule vms) kätte. Hoidke uued ja kasutatud patareid lastele kättesaamatus kohas. Utiliseerimise või ringlussevõtu teabe saamiseks võtke ühendust kohalike asutustega.



HOIATUS: Plahvatusoht, kui aku on valesti vahetatud. Asenda ainult sama või samaväärse tüübiga.

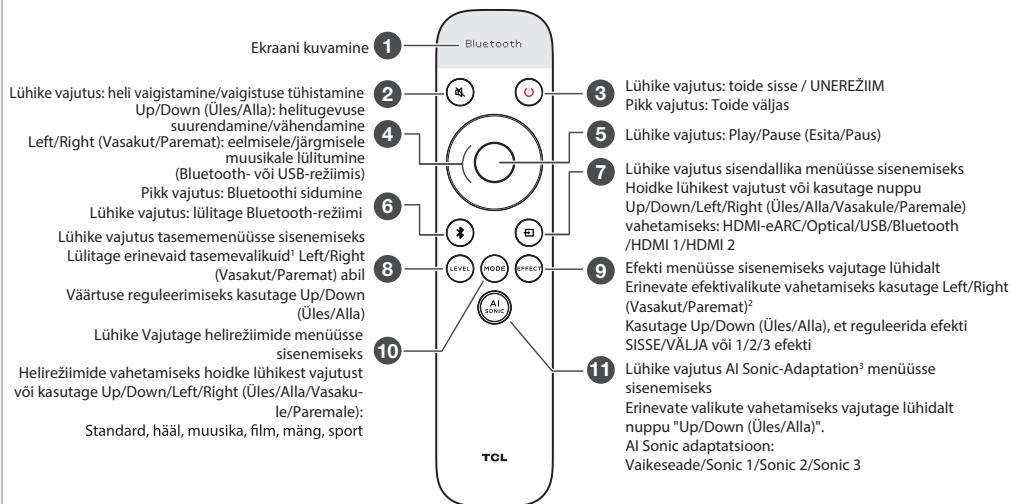
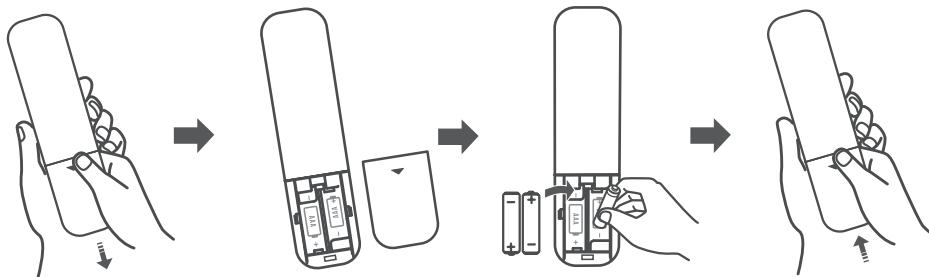

1. Tasemevalikud: Bass, Treble, Dialogue, SurrVol, Av Sync.

2. Efektivalkud: Bass Boost, Surround Enhance, Pass through, Night, NEURALX, DRC, LED Dim.

3. AI-Sonicu kohandamine: Lisateavet leiate jaotisest 8.

Märge:

Tehasrežiim: Vajutage Mode+Mute (Režiim+Vaigistus) 5 sekundit koos pikalt.

6a



FI

Akun tyyppi: 1,5 V:n AAA-akku x 2

G

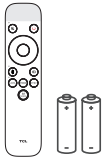

Varoitus: Älä altista paristoja liialliselle kuumuudelle, kuten auringonpaisteelle, tulelle tai vastaavalle. Pidä kaikki uudet tai käytetyt paristot loitolla lasten ulottuvilta. Ota yhteyttä paikallisiin viranomaisiin saadaksesi hävittämis- tai kierrätystietoja.



VAROITUS: Jos akku vaihdetaan väärin, on olemassa räjähdysvaara. Vaihda vain samantyyppisiin tai vastaaviin.

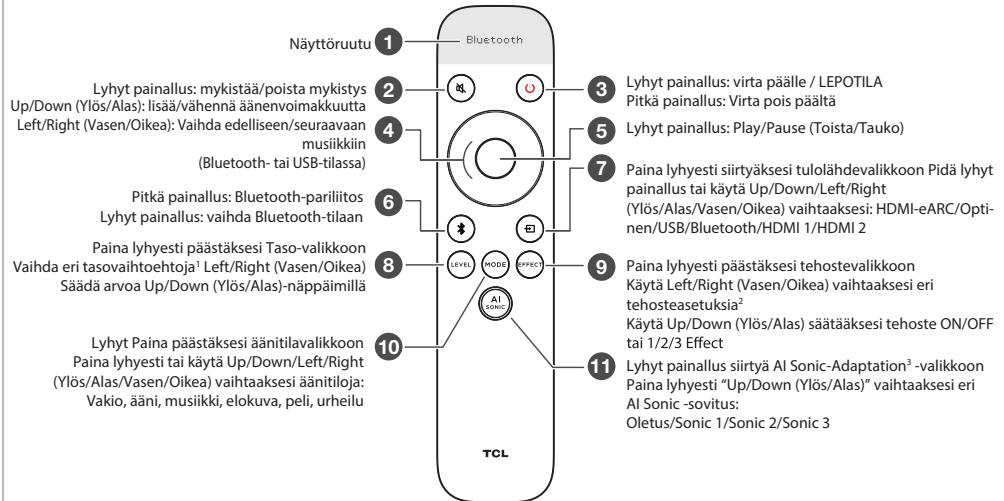
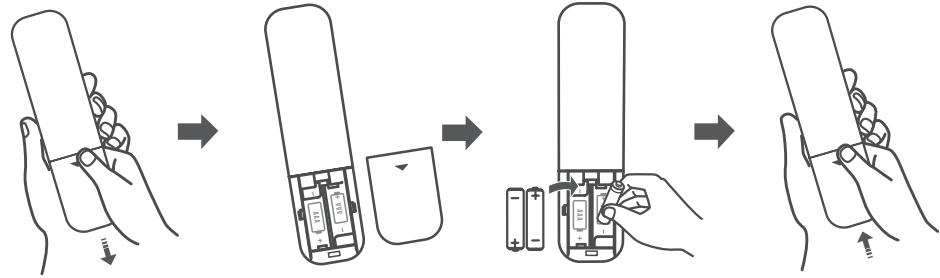

1. Tasovaihtoehdot: Bass, Treble, Dialogue, SurrVol, Av Sync.

2. Tehostevaihtoehdot: Bass Boost, Surround Enhance, Pass through, Night, NEURALX, DRC, LED Dim.

3. AI-Sonic-sovitus: Lisätietoja on osiossa 8.

Merkintä:

Tehdastila: Pitkä Mode+Mute (painallustila +Mykistä) yhdessä 5 sekunnin ajan.

6a



Type de batterie : Batterie AAA 1,5V x 2

G

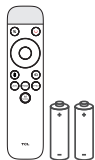

! Avertissement : N'exposez pas les piles à une chaleur excessive, telle que le soleil, le feu, etc.). Conservez les piles neuves et usagées hors de portée des enfants. Veuillez contacter les autorités locales pour des informations sur la mise au rebut ou le recyclage.

! ATTENTION : Risque d'explosion si les piles sont incorrectement remplacées. Remplacez exclusivement par les piles de type similaire ou équivalent.

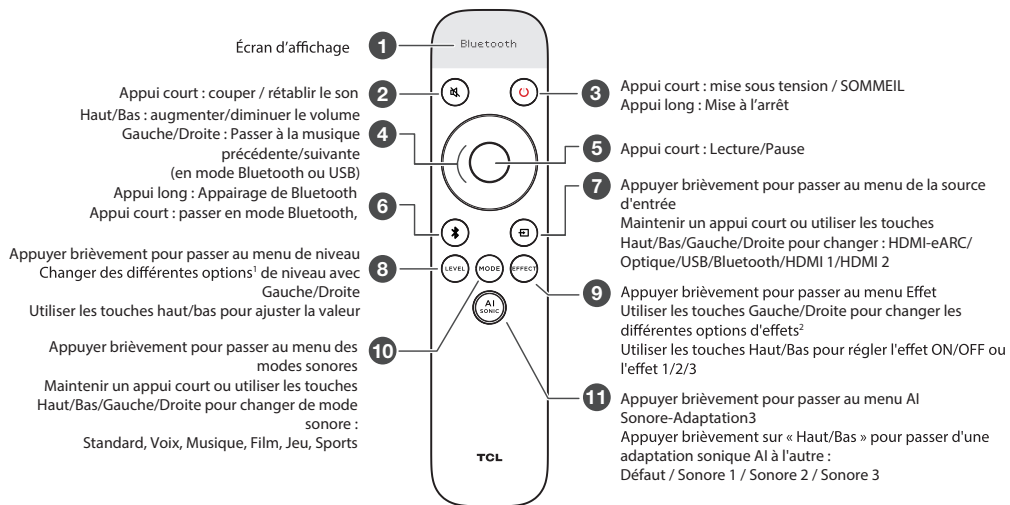
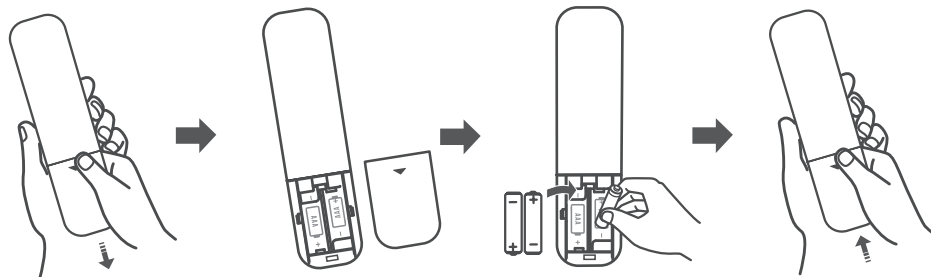

1. Options de niveau : Bass, Treble, Dialogue, SurrVol, Av Sync.

2. Options d'effets : Bass Boost, Surround Enhance, Pass through, Night, NEURALX, DRC, LED Dim.

3. Adaptation AI-Sonic : Voir la section 8 pour plus de détails.

Remarque :

Mode usine : Appuyer longuement sur Mode+Muet en même temps pendant 5 secondes.

6a



Batterietyp: 1,5 V AAA Batterie x 2

G

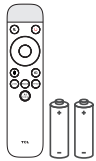

! Warnung: Setzen Sie die Batterien nicht übermäßiger Hitze aus, wie z. B. Sonnenlicht, Feuer oder Ähnlichem. Halten Sie neue und gebrauchte Batterien von Kindern fern. Für Informationen zur Entsorgung oder zum Recycling wenden Sie sich bitte an Ihre örtlichen Behörden.

! ACHTUNG: Es besteht Explosionsgefahr, wenn die Batterien nicht korrekt ersetzt werden. Ersetzen Sie die Batterien nur durch denselben oder einen gleichwertigen Typ.

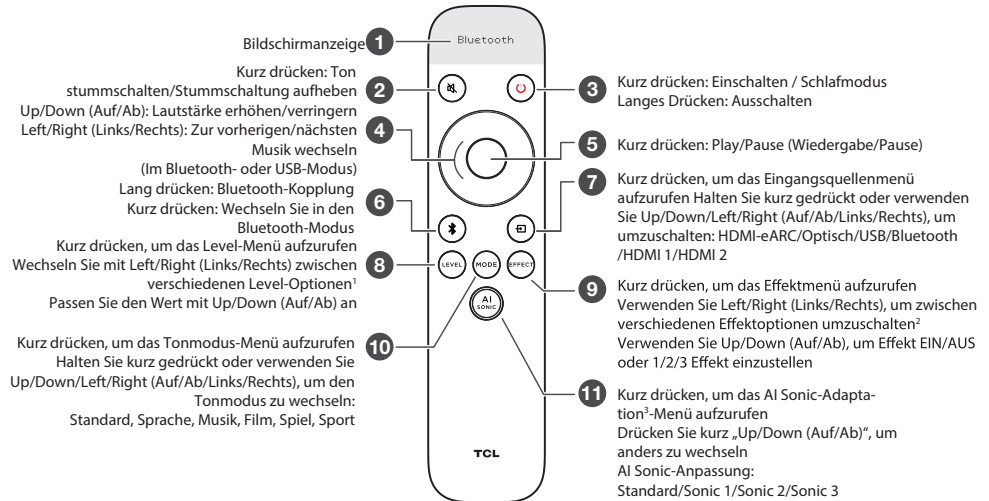
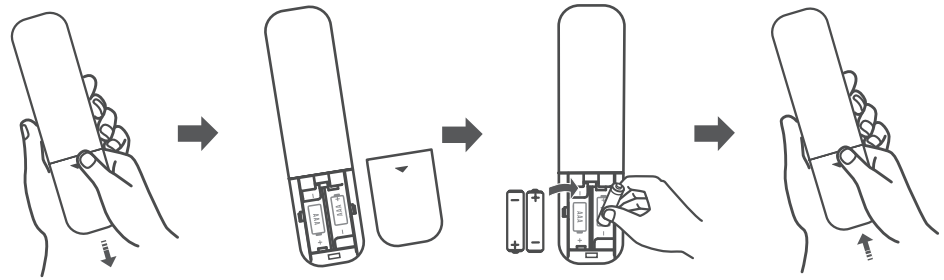

1. Level-Optionen: Bass, Treble, Dialogue, SurrVol, Av Sync.

2. Effektoptionen: Bass Boost, Surround Enhance, Pass through, Night, NEURALX, DRC, LED Dim.

3. AI-Sonic-Anpassung: Erfahren Sie mehr in Abschnitt 8.

Notiz:

Werkeinstellung: Drücken Sie 5 Sekunden lang gleichzeitig die Tasten Mode+Mute (Modus + Stummschalten)

6a



Τύπος Μπαταρίας: Μπαταρία AAA 1,5V x 2

G

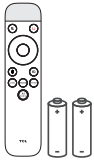

Προειδοποίηση: Μην εκθέτετε τις μπαταρίες σε υπερβολική θερμότητα όπως ηλιοφάνεια, φωτιά ή παρόμοια. Φυλάξτε τις μπαταρίες, καινούριες και χρησιμοποιημένες, μακριά από τα παιδιά. Επικοινωνήστε με τις τοπικές αρχές για πληροφορίες απόρριψης ή ανακύκλωσης.



ΠΡΟΣΟΧΗ: Εάν η μπαταρία αντικατασταθεί εσφαλμένα, υπάρχει κίνδυνος έκρηξης. Αντικαταστήστε μόνο με τον ίδιο ή ισοδύναμο τύπο.

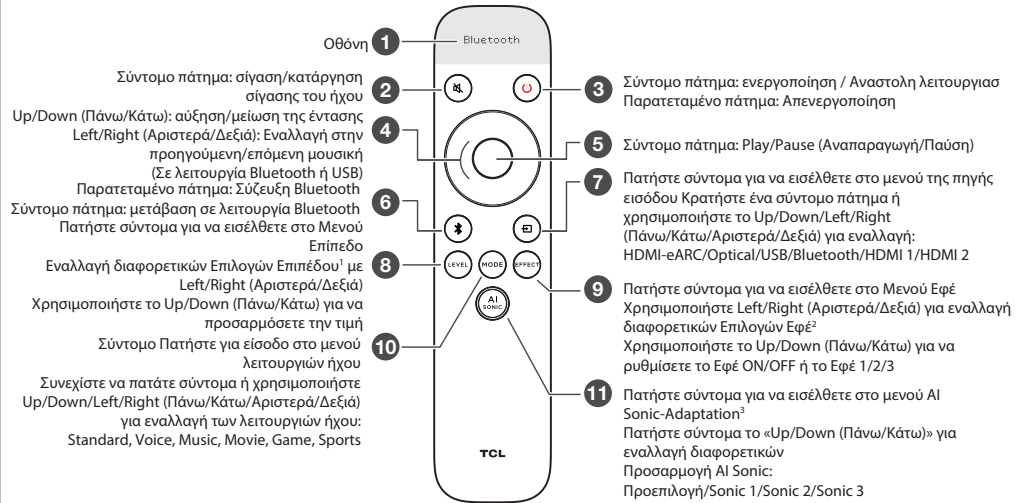
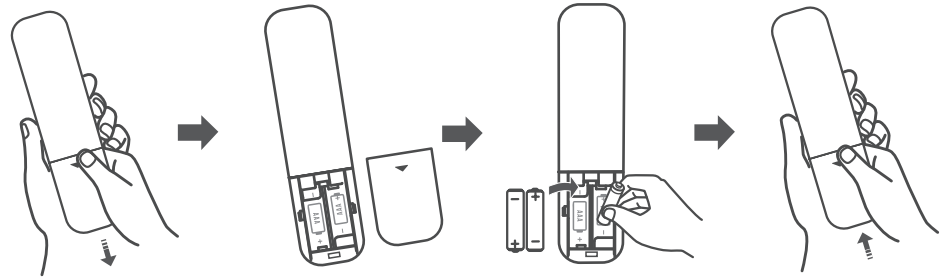

1. Επιλογές επιπέδου: Bass, Treble, Dialogue, SurrVol, Av Sync.

2. Επιλογές εφέ: Bass Boost, Surround Enhance, Pass through, Night, NEURALX, DRC, LED Dim.

3. Προσαρμογή AI-Sonic: Μάθετε περισσότερα στην Ενότητα 8.

Σημείωση:

Εργασιαστική λειτουργία: Πατήστε παρατεταμένα τα πλήκτρα Mode+Mute (Λειτουργία + Σίγαση) μαζί για 5 δευτερόλεπτα.



Tip baterije: 1,5 V-os AAA elem x 2

G

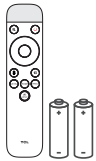

! Figyelmeztetés: Ne tegye ki az akkumulátorokat túlzott hőhatásnak, például napsütésnek, tűznek vagy hasonlónak. Az új és használt elemeket tartsa távol a gyermekektől. Az ártalmatlanítással vagy újrahasznosítással kapcsolatos információkért forduljon a helyi hatóságokhoz.

! VIGYÁZAT! Robbanásveszély az akkumulátor helytelen cseréje esetén. Zamenajte samo z enakim ali enakovrednim tipom.

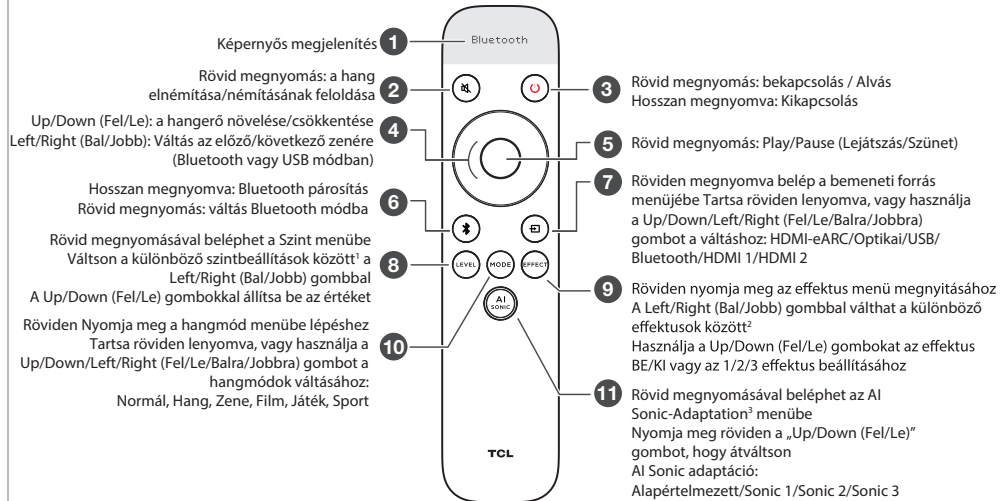
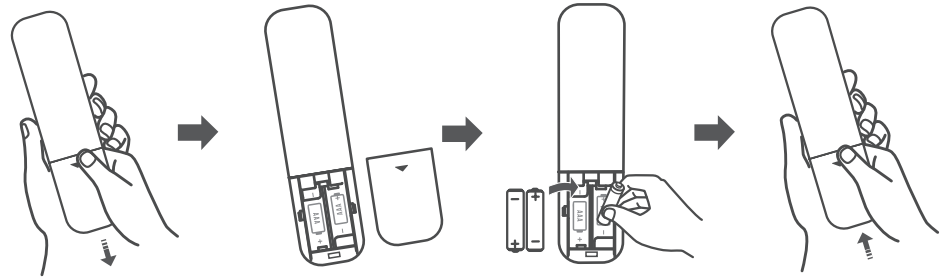

1. Szint opciók: Bass, Treble, Dialogue, SurrVol, Av Sync.

2. Effektusopciók: Bass Boost, Surround Enhance, Pass through, Night, NEURALX, DRC, LED Dim.

3. AI-Sonic adaptáció: További információ a 8. részben.

Jegyzet:

Gyári üzemmód: Hosszan nyomja meg a Mode+Mute (Mód+Némítás) billentyükombinációt 5 másodpercig.

6a



Tipo di batteria: Batteria 1.5V AAA x 2

G

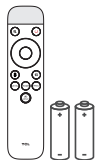

! Avvertimento: Non esporre le batterie a calore eccessivo come sole, fuoco o simili. Tenere le batterie, sia nuove che usate, lontano dai bambini. Per informazioni sullo smaltimento o sul riciclaggio, si prega di contattare le autorità locali.

! CAUTELA: Pericolo di esplosione se la batteria viene sostituita in modo errato. Sostituire solo con una batteria dello stesso tipo o con una equivalente

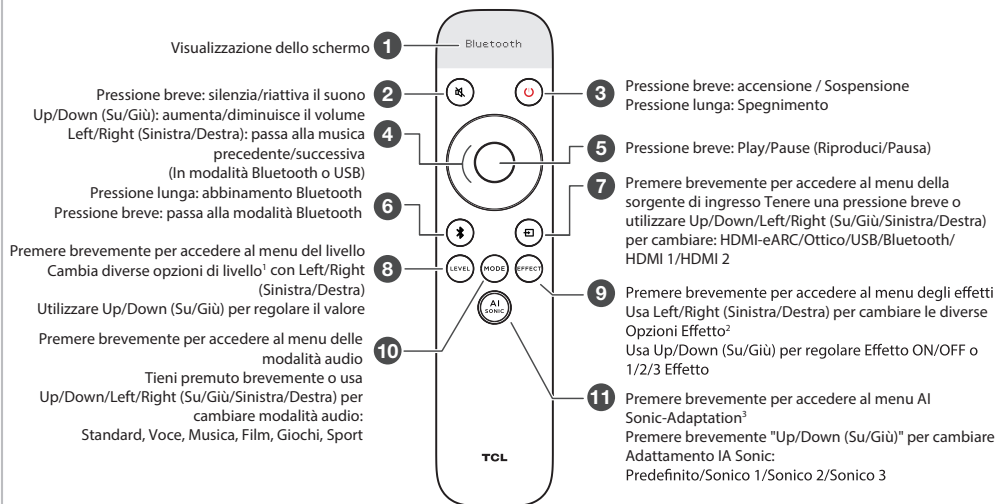
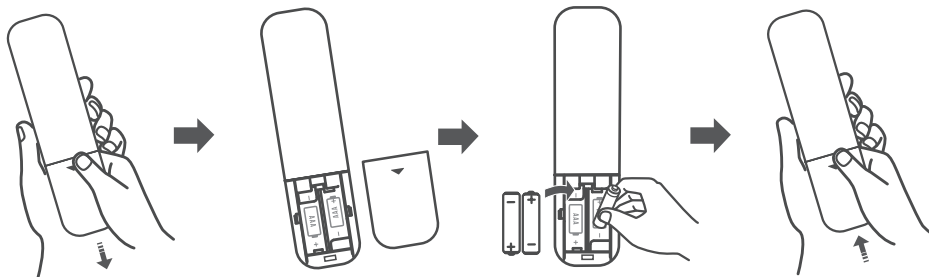

1. Opzioni di livello: Bass, Treble, Dialogue, SurrVol, Av Sync.
2. Opzioni effetto: Bass Boost, Surround Enhance, Pass through, Night, NEURALX, DRC, LED Dim.
3. Adattamento AI-Sonic: Ulteriori informazioni nella Sezione 8.

Nota:

Modalità di fabbrica: Premere a lungo Mode+Mute (Modalità+Muto) insieme per 5 secondi.



Baterijas veids: 1,5V AAA baterija x 2

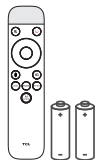

Brīdinājums: Nepakļaujiet baterijas pārmērīgam karstumam, piemēram, saules stariem, ugunij vai tamlīdzīgiem apstākļiem. Jaunas un lietotas baterijas glabājiņiet bērniem nepieejamā vietā. Lai iegūtu informāciju par utilizāciju vai pārstrādi, lūdzu, sazinieties ar savu vietējo pašvaldību.



UZMANĪBU: Eksplozijas risks, ja baterija tiek nepareizi nomainīta. Bateriju nomainiet tikai ar tādu pašu vai līdzvērtīgu tipu.

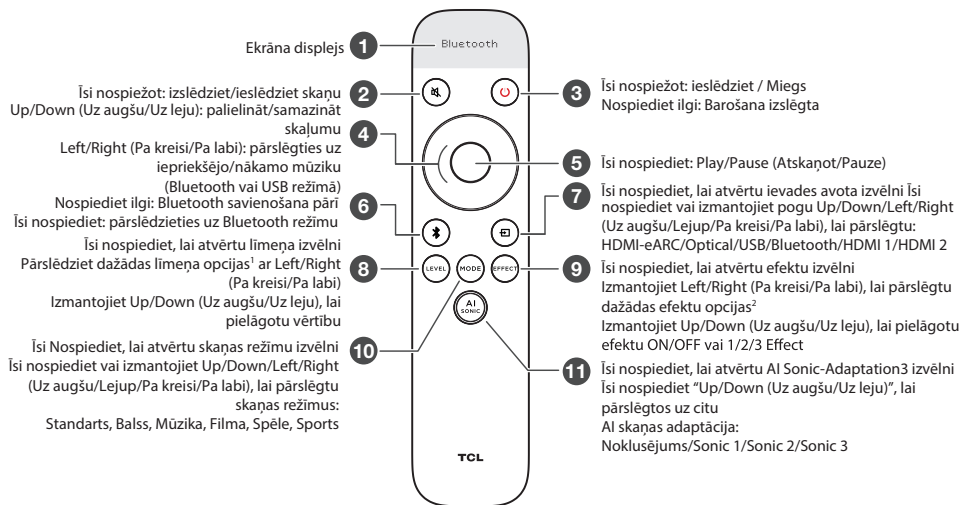
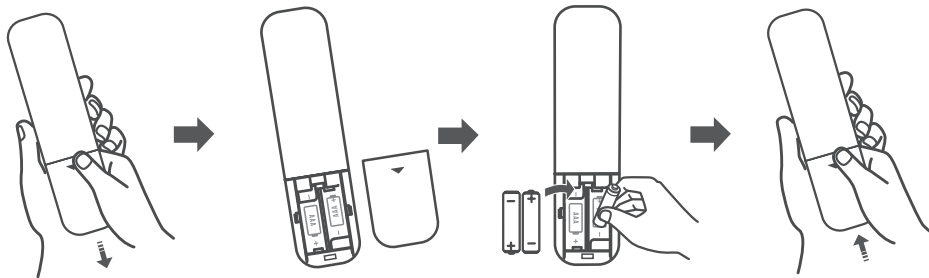

1. Līmeņa opcijas: Bass, Treble, Dialogue, SurrVol, Av Sync.

2. Efektu opcijas: Bass Boost, Surround Enhance, Pass through, Night, NEURALX, DRC, LED Dim.

3. AI-Sonic adaptācija: uzziniet vairāk 8. sadaļā.

Piezīme:

Rūpnīcas režīms: ilgi nospiediet Mode+Mute (Režīms + Izslēgts) 5 sekundes vienlaikus



Baterijos tipas: 1.5V AAA baterija x 2

G

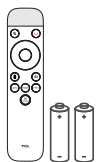

Įspėjimas: Nelaikykite akumuliatorių per dideliame karštyje, pavyzdžiui, saulėje, ugnyje ar pan. Laikykite naujas ir naudotas baterijas atokiau nuo vaikų. Dėl informacijos apie šalinimą ar perdirbimą kreipkitės į vietos valdžios institucijas.



ATSARGIAI: Netinkamai pakeitus akumuliatorių kyla sprogimo pavojus. Keiskite tik to paties arba lygiavertčio tipo.

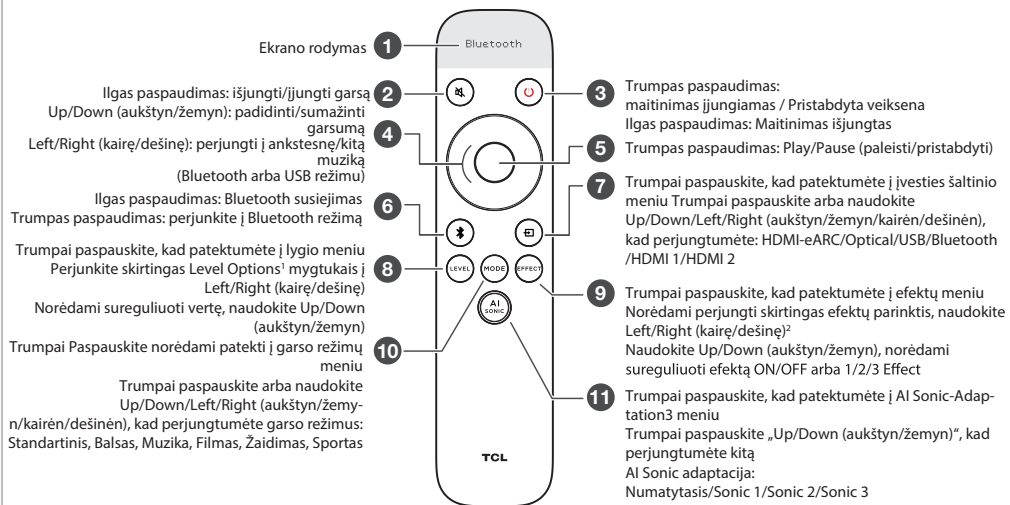
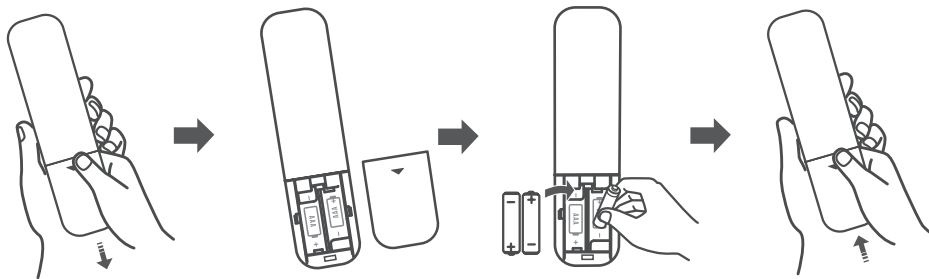



Тип на батерији: 1.5V AAA батерија x 2

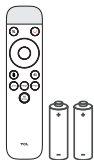

Предупредување: Не ги изложувајте батериите на преголема толлина како на пример сонце, оган или слично. Чувајте ги новите и употребените батерии настрана од дофат на деца. За информации за фрлање или рециклирање, ве молиме контактирајте ги локалните одговорни лица.



ВНИМАНИЕ: Опасност од експлозија доколку батеријата е неправилно заменета. Заменете само со исти или еквивалентен тип.

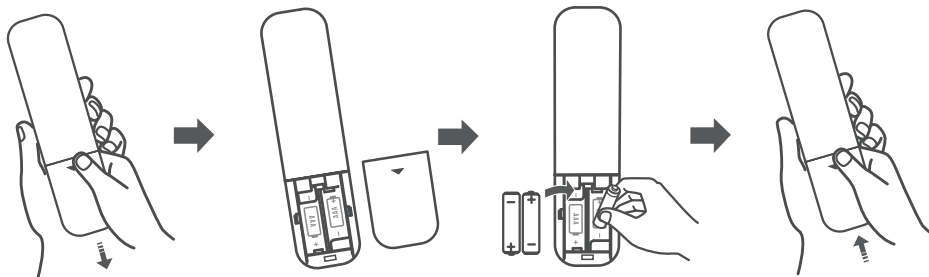

1. Опции за ниво: Bass, Treble, Dialogue, SurrVol, Av Sync.

2. Опции за ефект: Bass Boost, Surround Enhance, Pass through, Night, NEURALX, DRC, LED Dim.

3. AI-Sonic адаптација: Дознајте повеќе во Дел 8.

Забелешка:

Фабрички режим: Долго притиснете Mode+Mute (Режим + Исклучување) заедно 5 секунди.

6a



NO

Batteritype: 1,5 V AAA-batteri x 2

G

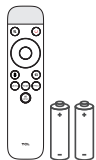

! Advarsel: Ikke utsett batteriene for høy varme som solskinn, brann eller lignende. Hold nye og brukte batterier unna barn. Ta kontakt med lokale myndigheter for informasjon om avhending eller resirkulering.

! FORSIKTIGHET: Hvis batteriet byttes ut på feil måte, er det eksplosjonsfare. Erstatt bare med samme eller tilsvarende type.

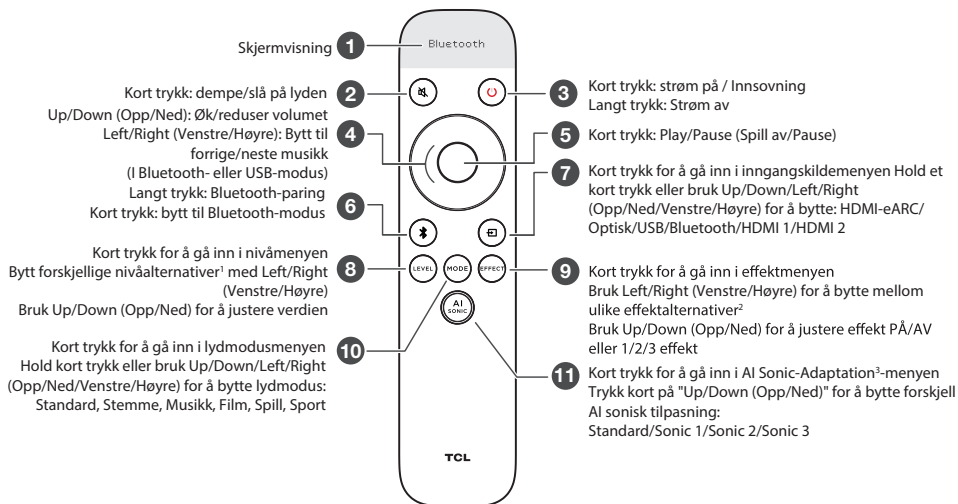
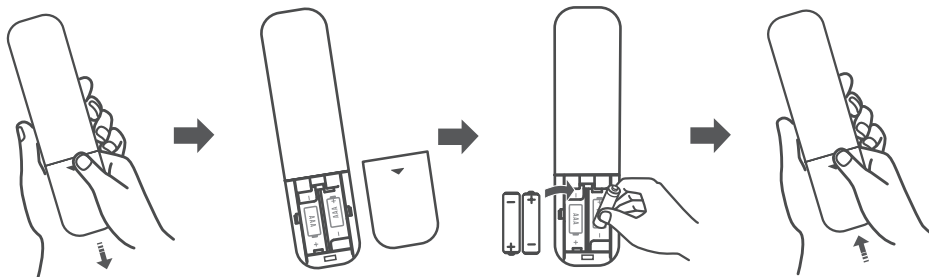

1. Nivåalternativer: Bass, Treble, Dialogue, SurrVol, Av Sync.

2. Effekalternativer: Bass Boost, Surround Enhance, Pass through, Night, NEURALX, DRC, LED Dim.

3. AI-Sonic-tilpasning: Lær mer i avsnitt 8.

Merk:

Fabrikkmodus: Mode+Mute (Langtrykkmodus+Demp) sammen i 5 sekunder.

6a



Typ baterii: Bateria AAA 1,5 V x 2

G

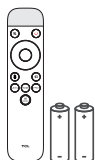

! **Ostrzeżenie:** Nie wystawiaj baterii na działanie nadmiernego ciepła, takiego jak słońce, ogień lub podobne. Nowe i zużyte baterie należy umieścić poza zasięgiem dzieci. Skontaktuj się z lokalnymi władzami, aby uzyskać informacje na temat utylizacji lub recyklingu.

! **OSTROŻNOŚĆ:** Jeśli bateria zostanie nieprawidłowo wymieniona, istnieje ryzyko wybuchu. Wymieniaj wyłącznie baterie tego samego lub równoważnego typu.

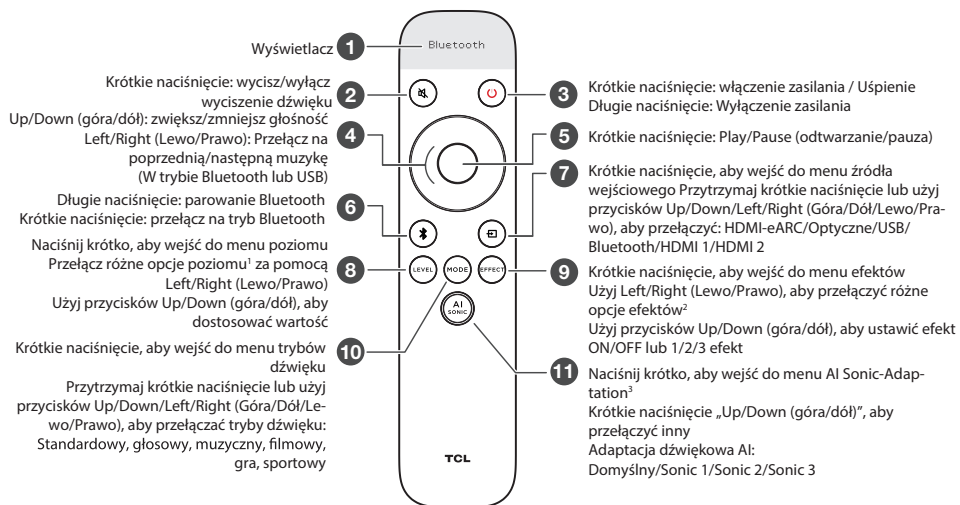
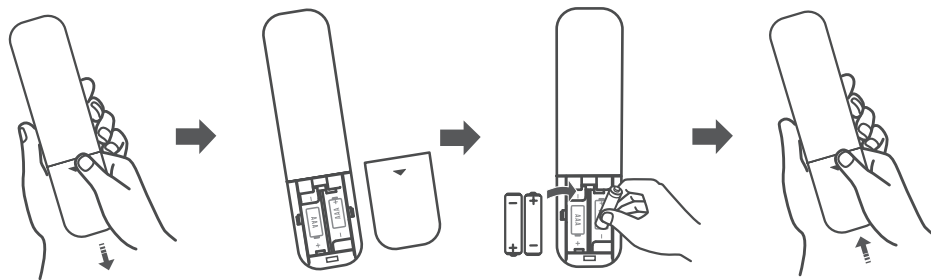

1. Opcje poziomu: Bass, Treble, Dialogue, SurrVol, Av Sync.

2. Opcje efektów: Bass Boost, Surround Enhance, Pass through, Night, NEURALX, DRC, LED Dim.

3. Adaptacja AI-Sonic: Dowiedz się więcej w sekcji 8.

Notatka:

Tryb fabryczny: Tryb długiego Mode+Mute (Nacisnięcia+Wyciszenie) razem przez 5 sekund.

6a



Tipo de bateria: Bateria 1.5V AAA x 2

G

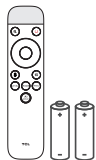

! Aviso: Não exponha as baterias a calor excessivo, tais como, sol, fogo, ou algo semelhante. Mantenha as baterias novas e usadas afastadas das crianças. Para informações sobre eliminação ou reciclagem, por favor, contate as autoridades locais.

! CUIDADO: Perigo de explosão se a bateria for substituída incorretamente. Substitua apenas pelo mesmo tipo ou equivalente.

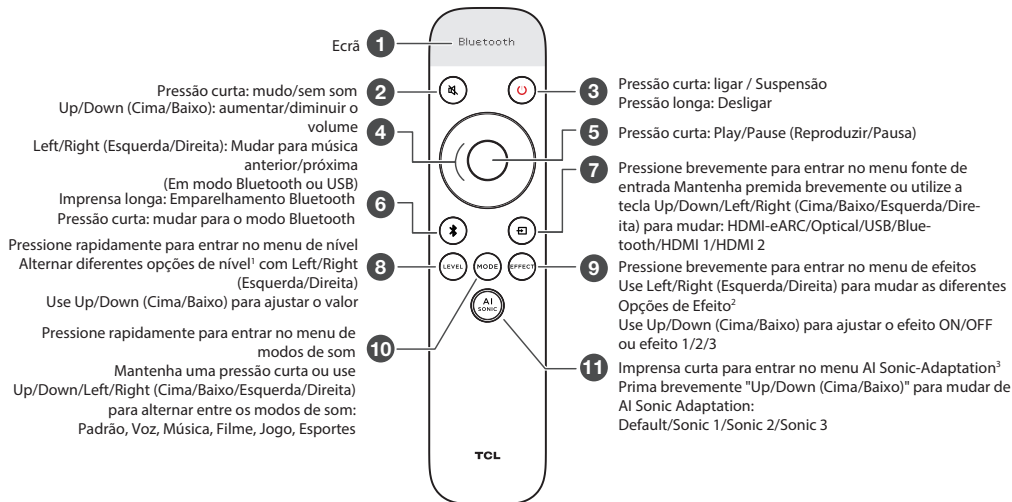
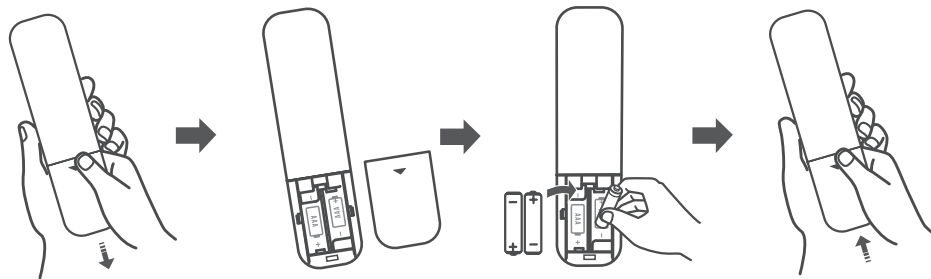

1. Opções de Nível: Bass, Treble, Dialogue, SurrVol, Av Sync.

2. Opções de Efeito: Bass Boost, Surround Enhance, Pass through, Night, NEURALX, DRC, LED Dim.

3. Adaptação AI-Sonic: Saiba mais na Secção 8.

Nota:

Modo Fábrica: Pressione longamente Mode+Mute (Modo+Mudo) juntos durante 5 segundos.

6a



Tip baterie: 1.5V baterie AAA x 2

G

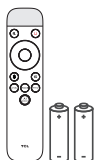

! Avertizare: Să nu expuneți bateriile la căldură excesivă, cum este soarele, focul etc. Țineți departe de copii bateriile noi și uzate. Pentru informații despre aruncare sau reciclare, vă rugăm să contactați autoritățile locale.

! ATENȚIE: Pericol de explozie în cazul în care bateria este înlocuită incorect. Înlocuiți numai cu același tip sau echivalent.

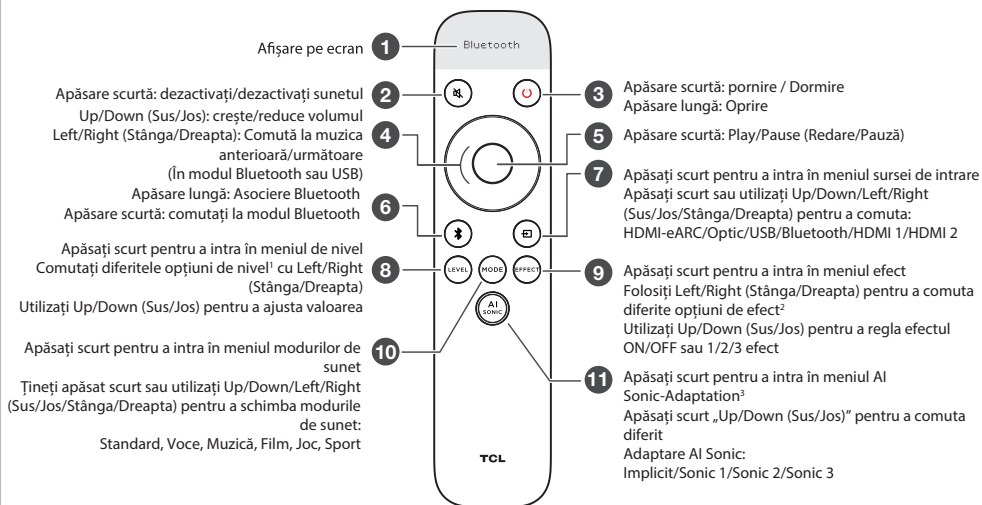
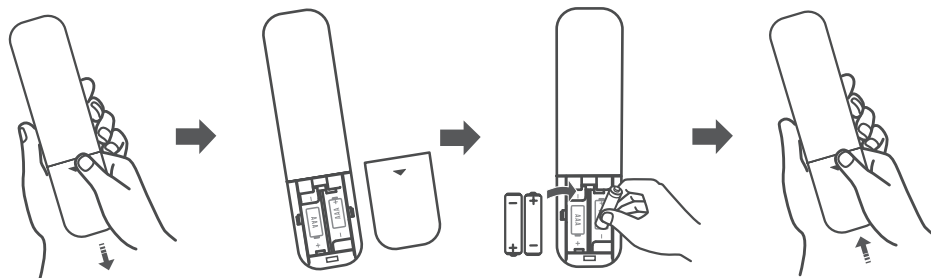

1. Opțiuni de nivel: Bass, Treble, Dialogue, SurrVol, Av Sync.

2. Opțiuni de efect: Bass Boost, Surround Enhance, Pass through, Night, NEURALX, DRC, LED Dim.

3. Adaptare AI-Sonic: Aflați mai multe în Secțiunea 8.

Notă:

Mod Fabrica: Apasai Lung împreuna Mode+Mute (Mod + Mute) timp de 5 secunde.

6a



Тип батареи: батарея 1,5 В AAA x 2

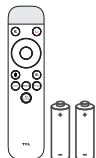

! Предупреждение: Не подвергайте батареи чрезмерному нагреву, например, солнечным лучам, огню и т.п. Храните новые и использованные батарейки в недоступном для детей месте. Для получения информации об утилизации или переработке обратитесь в местные органы власти.

! ВНИМАНИЕ: Опасность взрыва при неправильной замене батареи. Заменяйте только на такие же или аналогичные.

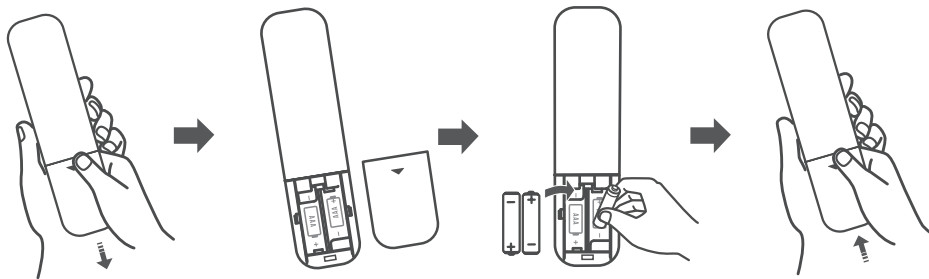

Экранный дисплей **1** Bluetooth

2 Короткое нажатие: отключить/включить звук
Up/Down (Вверх/Вниз): увеличить/уменьшить громкость
Left/Right (Влево/Вправо): Переключение на предыдущую/следующую музыку (В режиме Bluetooth или USB)

3 Короткое нажатие: питание включено / Спящий режим
Длительное нажатие: Питание выключено

4 Длительное нажатие: Сопряжение по Bluetooth
Короткое нажатие: Переключение в режим Bluetooth

5 Короткое нажатие: Воспроизведение / Пауза

6 Короткое нажатие для входа в Level Menu (Меню Уровня)
Переключение различных Level Options¹ (Вариантов уровня)² с помощью кнопки Left/Right (Влево/Вправо)
Использование кнопки Up/Down (Вверх/Вниз) для настройки значения

7 Короткое нажатие для входа в меню источника входного сигнала
Держание короткого нажатия или использование кнопки Up/Down/Left/Right (Вверх/Вниз/Влево/Вправо) для переключения: HDMI-eARC/Optical (Оптический)/USB/Bluetooth/HDMI 1/HDMI 2

8 Короткое нажатие для входа в Effect Menu (Меню Эффекта)
Использование кнопки Left/Right (Влево/Вправо) для переключения различных Effect Options² (Варианты эффекта)³
Использование кнопки Up/Down (Вверх/Вниз) для настройки Effect ON/OFF (Эффект ВКЛ/ВЫКЛ) или 1/2/3 Effect (Эффект 1/2/3)

9 Короткое нажатие для входа в меню звуковых режимов
Держание короткого нажатия или использование кнопки Up/Down/Left/Right (Вверх/Вниз/Влево/Вправо) для переключения режимов звука:
Стандарт, Голос, Музыка, Кино, Игра, Спорт

10 Короткое нажатие для входа в меню AI Sonic-Adaptation³ (ИИ-Звуковая адаптация)³
Короткое нажатие «Up/Down» (Вверх/Вниз) для переключения различных AI Sonic Adaptation (ИИ-Звуковых адаптаций): По умолчанию / Звуковой 1 / Звуковой 2 / Звуковой 3

11 Короткое нажатие для входа в меню AI Sonic-Adaptation³ (ИИ-Звуковая адаптация)³
Короткое нажатие «Up/Down» (Вверх/Вниз) для переключения различных AI Sonic Adaptation (ИИ-Звуковых адаптаций): По умолчанию / Звуковой 1 / Звуковой 2 / Звуковой 3

1. Варианты уровня: Bass, Treble, Dialogue, SurrVol, Av Sync.
2. Варианты эффекта: Bass Boost, Surround Enhance, Pass through, Night, NEURALX, DRC, LED Dim.
3. ИИ-Звуковая адаптация: Узнать больше в Разделе 8.
Примечание:
Заводской Режим: Длительное нажатие Mode+Mute (Режим+Отключение звука) вместе в течение 5 секунд.



Tip baterije: 1.5V AAA baterija x 2

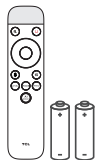

! Upozorenje: Ne izlažite baterije prekomernoj toploti kao što su sunce, vatra ili slično. Držite nove i polovne baterije dalje od dece. Obratite se lokalnim vlastima za informacije o odlaganju ili recikliranju.

! OPREZ: Ako je baterija neispravno zamenjena, postoji rizik od eksplozije. Zamijenite samo istom ili ekvivalentnom vrstom.

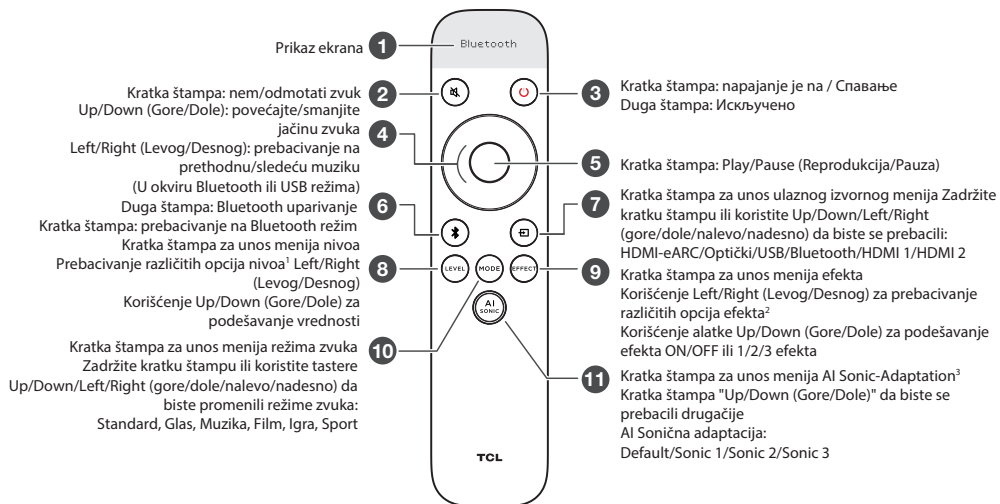
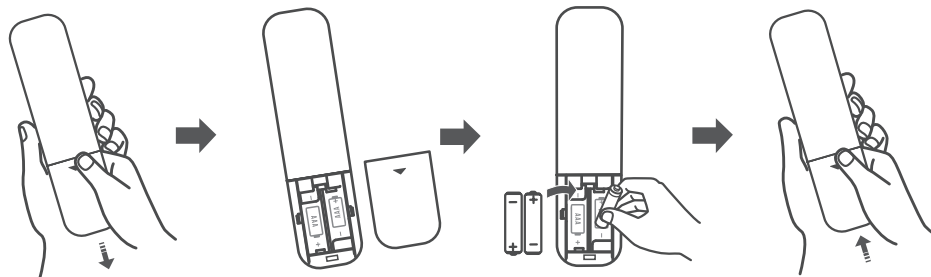

1. Opcije nivoa: Bass, Treble, Dialogue, SurrVol, Av Sync.

2. Opcije Effect: Bass Boost, Surround Enhance, Pass through, Night, NEURALX, DRC, LED Dim.

3.AI-Sonic Adaptation: Saznajte više u odeljku 8.

Nota:

Fabrički režim: Dugo pritisnite Mode+Mute (Režim+Mute) zajedno na 5 sekundi.

6a



Typ batérie: 1,5V batéria AAA x 2

G

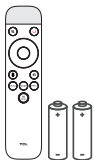

Upozornenie: Nevystavujte batériu nadmernému teplu, ako je slnečné žiarenie, oheň a podobne. Nové aj použité batérie uchovávajte mimo dosahu detí. Ak chcete získať informácie o likvidácii alebo recyklácii, obráťte sa na miestne úrady.



POZOR: V prípade nesprávnej výmeny batérie hrozí nebezpečenstvo výbuchu. Vymeríte iba za rovnaký alebo ekvivalentný typ.

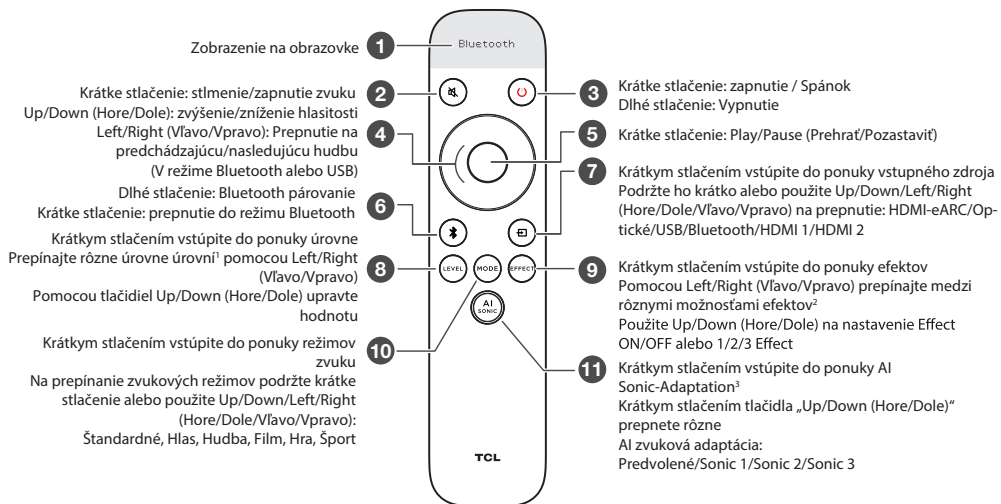
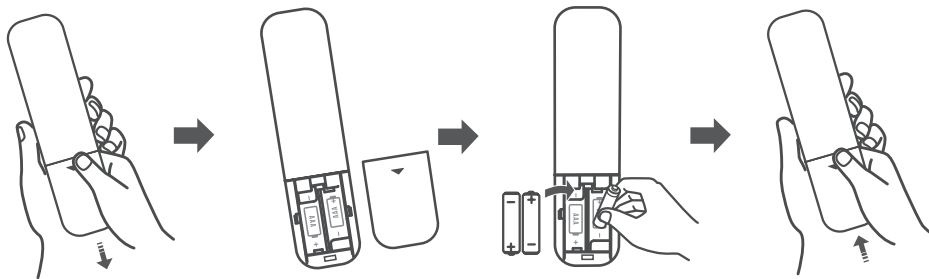

1. Možnosti úrovne: Bass, Treble, Dialogue, SurrVol, Av Sync.

2. Možnosti efektov: Bass Boost, Surround Enhance, Pass through, Night, NEURALX, DRC, LED Dim.

3. Adaptácia AI-Sonic: Viac sa dozviete v časti 8.

Poznámka:

Výrobné nastavenie: Dlhो stlačte Mode+Mute (Režim+Stlmené) spolu na 5 sekúnd.

6a



Tip baterije: 1.5V AAA baterija x 2

G

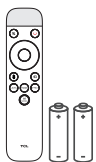

Opozorilo: Baterij ne izpostavljajte previsoki vročini, kot npr. sonce, ogenj ipd. Nove in že rabljene baterije hranite stran od otrok. Za informacije o odlaganju ali recikliranju se obrnite na lokalne oblasti.



POZOR: Nevarnost eksplozije, če baterije ne zamenjate pravilno. Zamenjajte samo z enakim ali enakovrednim tipom.

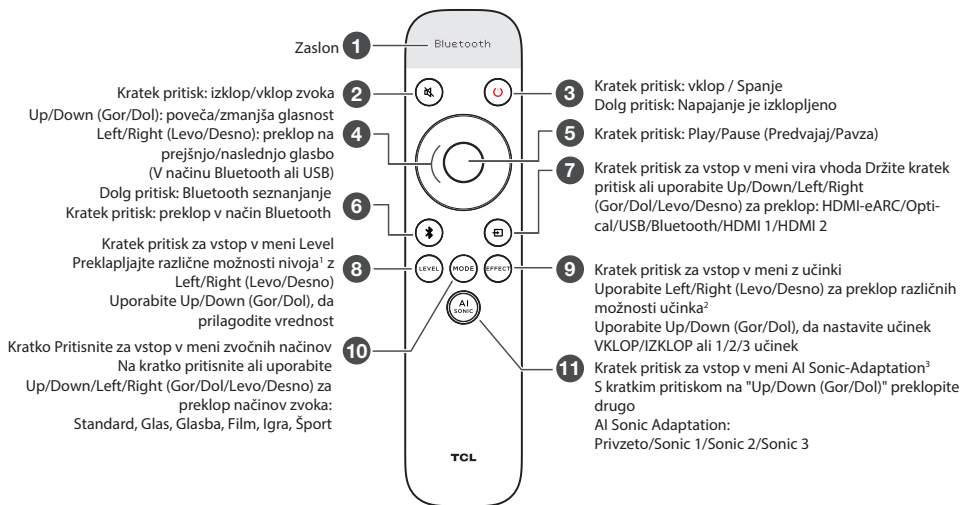
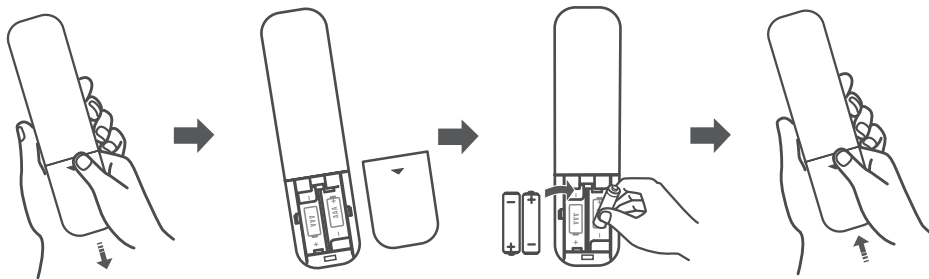

1. Možnosti nivoja: Bass, Treble, Dialogue, SurrVol, Av Sync.

2. Možnosti učinka: Bass Boost, Surround Enhance, Pass through, Night, NEURALX, DRC, LED Dim.

3. Prilagoditev AI-Sonic: Več o tem v 8. razdelku.

Opomba:

Tovarniški način: Pridržite Mode+Mute (Nacin+Brez zvoka) skupaj za 5 sekund.



Tipo de batería: batería AAA de 1,5 V x 2

G

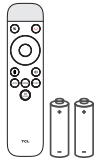

Advertencia: No exponer las baterías al calor excesivo, como la luz del sol, el fuego o similares. Mantener las baterías nuevas y usadas fuera del alcance de los niños. Para obtener información sobre cómo desechar o reciclar, comunicarse con las autoridades locales.



PRECAUCIÓN: Peligro de explosión si la batería se reemplaza incorrectamente. Reemplazar solamente con el mismo tipo o equivalente.

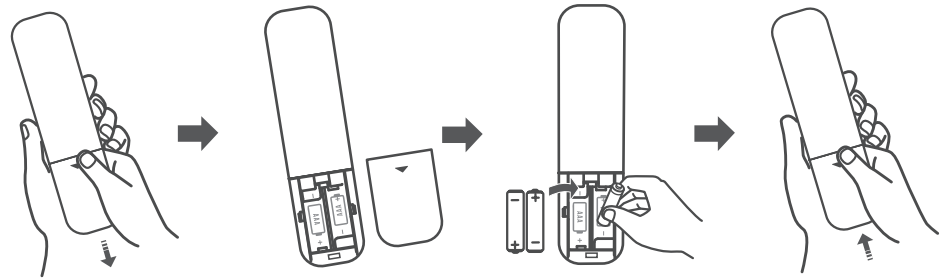

Visualización de la pantalla 1

Bluetooth

2 Pulsación corta: silenciar/reactivar el sonido
Arriba/Abajo: aumentar/disminuir el volumen
Izquierda/ Derecha:
Cambiar a la última/siguiente canción
(Bajo el modo Bluetooth o USB)

3 Pulsación corta: encendido / Temporizador
Pulsación larga: Apagado

4 Pulsación larga: Emparejar Bluetooth
Pulsación corta: cambiar al modo Bluetooth

5 Pulsación corta: Reproducir / Pausar

6 Presionar brevemente para entrar en el Menú de Nivel
Cambiar entre diferentes opciones de nivel¹ con
Izquierda/Derecha

7 Presionar brevemente para ingresar al menú de
fuente de entrada Mantener presionado brevemente
o usar Arriba/Abajo/Izquierda/Derecha para cambiar:
HDMI-eARC/Optico/USB/Bluetooth/HDMI 1/HDMI 2

8 Usar Arriba/Abajo para ajustar el valor

9 Presionar brevemente para ingresar al Menú de Efectos
Usar Izquierda/Derecha para cambiar diferentes Opciones
de Efectos²
Usar Arriba/Abajo para ajustar el ENCENDIDO/APAGADO de
Efecto o el 1/2/3 de Efecto

10 Presionar brevemente para ingresar al menú de
modos de sonido
Presionar brevemente o usar Arriba/Abajo/Izquier-
da/Derecha para cambiar los modos de sonido:
Estándar, Voz, Música, Películas, Juegos, Deportes

11 Presionar brevemente para ingresar al Menú de
Adaptación Sónica IA³
Presionar brevemente "Arriba/Abajo" para cambiar
diferentes
Adaptación de IA Sónico:
Predeterminado / Sónico 1 / Sónico 2 / Sónico 3

TCL

1. Opciones de Nivel: Bass, Treble, Dialogue, SurrVol, Av Sync.

2. Opciones de Bass Boost, Surround Enhance, Pass through, Night, NEURALX, DRC, LED Dim.

3. Adaptación de IA Sónico: Obtener más información en la Sección 8.

Nota:

Modo de Fábrica: Mantener presionado Modo + Silenciar juntos durante 5 segundos.

6a

SV



Batterityp: 1,5V AAA-batteri x 2

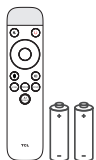

Varning: Utsätt inte batterierna för överdriven värme som solsken, eld eller liknande. Håll nya och använda batterier borta från barn. Kontakta dina lokala myndigheter för information om bortskaftande eller återvinning.



FÖRSIKTIGHET: Om batteriet byts ut felaktigt finns det en explosionsrisk. Ersätt endast med samma eller motsvarande typ.

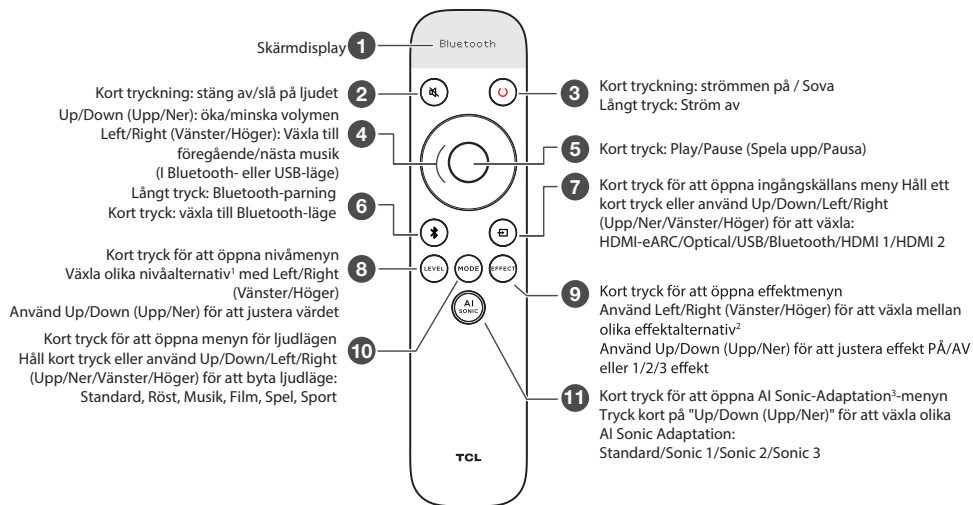
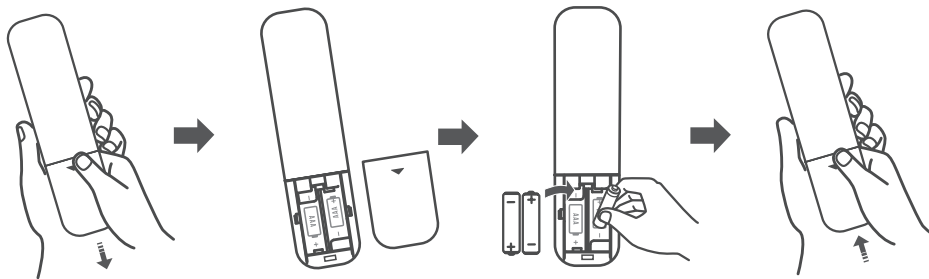

1. Nivåalternativ: Bass, Treble, Dialogue, SurrVol, Av Sync.

1. Effektmalternativ: Bass Boost, Surround Enhance, Pass through, Night, NEURALX, DRC, LED Dim.

3. AI-Sonic-anpassning: Läs mer i avsnitt 8.

Notera:

Fabriksläge: Långt Mode+Mute (Tryckläge+Stäng) av ljudet tillsammans i 5 sekunder



Pil Tipi: 1.5V AAA pil x 2

G

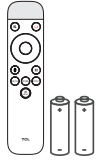

Uyarı: Pilleri güneş ışığı, ateş veya benzeri gibi aşırı ısıya maruz bırakmayın. Yeni ve kullanılmış pilleri çocuklardan uzak tutun. Atma veya geri dönüşüm bilgileri için lütfen yerel yetkililerle iletişime geçin.



DİKKAT: Pil yanlış değiştirilirse patlama tehlikesi. Yalnızca aynı veya eşdeğer türle değiştirin.

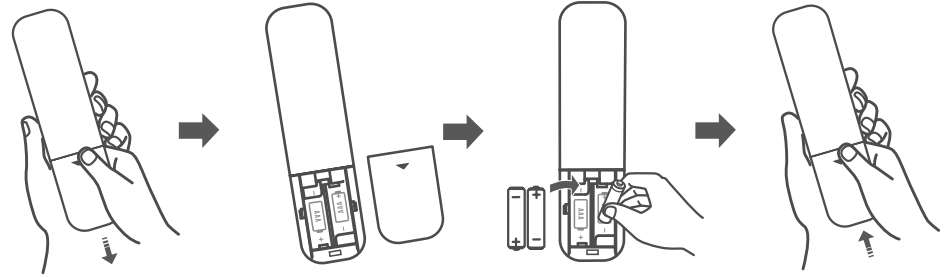

1. Seviye Seçenekleri: Bass, Treble, Dialogue, SurrVol, Av Sync.

2. Efekt Seçenekleri: Bass Boost, Surround Enhance, Pass through, Night, NEURALX, DRC, LED Dim.

3. AI-Sonic Adaptasyon: Bölüm 8'de daha fazla bilgi edinin.

Not:

Fabrika modu: Mode+Mute (Mod+Sessiz'e) birlikte 5 saniye boyunca uzun basın.

6a



Тип акумулятора: 1,5 В акумулятор AAA x 2

G

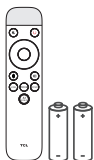

Попередження: Не піддавайте батареї надмірному теплу, такому як сонце, вогонь тощо. Тримайте нові і використані батареї подалі від дітей. Зверніться до місцевих органів влади для отримання інформації про утилізацію або переробку.



ОБЕРЕЖНІСТЬ: Якщо акумулятор неправильно замінено, є ризик вибуху. Замінійте лише на той самий або еквівалентний тип.

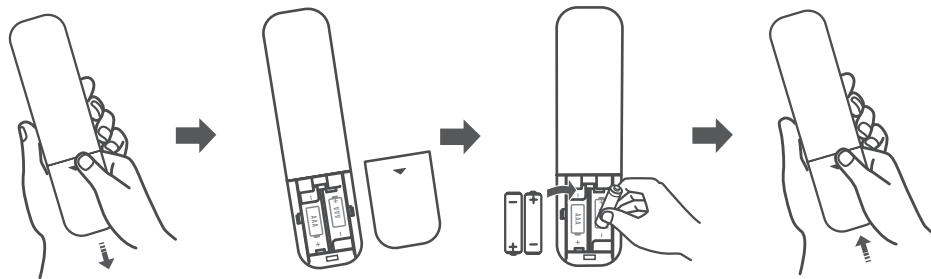

1. Параметри рівня: Bass, Treble, Dialogue, SurrVol, Av Sync.

2. Параметри ефекту: Bass Boost, Surround Enhance, Pass through, Night, NEURALX, DRC, LED Dim.

3. Адаптація AI-Sonic: дізнайтеся більше в Розділі 8.

Примітка:

Натисніть і утримуйте разом Mode+Mute (Режим + Без звуку) протягом 5 секунд.

7a



F

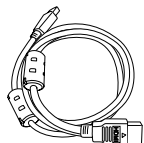

- EN** The most preferred connection options:
SQ Opsionet më të preferuara të lidhjes janë:
BG Препоръчителни варианти за свързване:
HR Najpoželjnije mogućnosti povezivanja:
CS Nejvhodnější možnosti připojení:
DA Foretrukne tilslutninger:
NL De meest geprefereerde verbindingsopties:
ET Kõige eelistatumad ühendused:
FI Suosituin yhteysvaihtohto:
FR Connexions à privilégier :
DE Die beliebtesten Anschlussarten:
EL Οι πιο προτιμώμενες επιλογές σύνδεσης:
HU A leginkább javasolt csatlakoztatási lehetőségek:
IT Le opzioni di collegamento preferite:
LV Ieteicamās savienojumu opcijas:
LT Priimtinausias ryšio galimybės:
MK Препорочитани опции за поврзување:
NO Tilkoblingsvalgene som oftest foretrekkes:
PL Najbardziejziej preferowane opcje połączeń:
PT As opções de ligação mais comuns:
RO Cele mai preferate opțiuni de conectare:
RU Предпочтительные варианты подключения:
SR Najpoželjniji načini povezivanja:
SK Najpreferovanejšie možnosti pripojenia:
SL Najbolj prijubljene možnosti povezave:
ES Opciones de conexión preferidas:
SV De mest föredragna anslutningsalternativen:
TR En çok kullanılan bağlantılar:
UA Найкращі опції з'єднання:

1) HDMI (ARC); 2) Optical

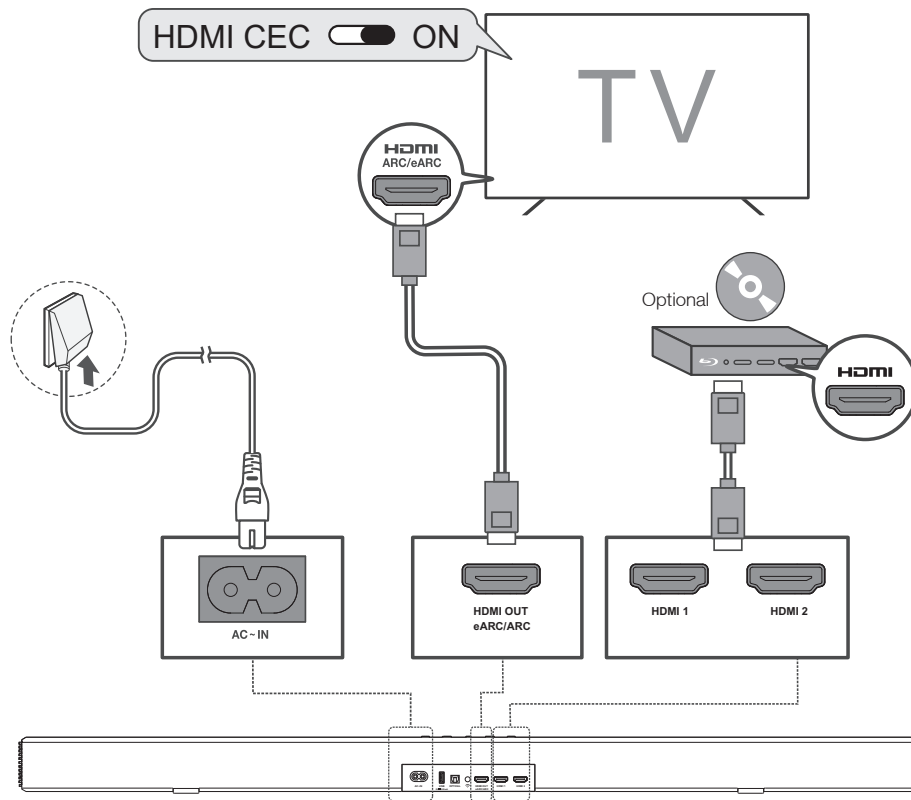

7a



F

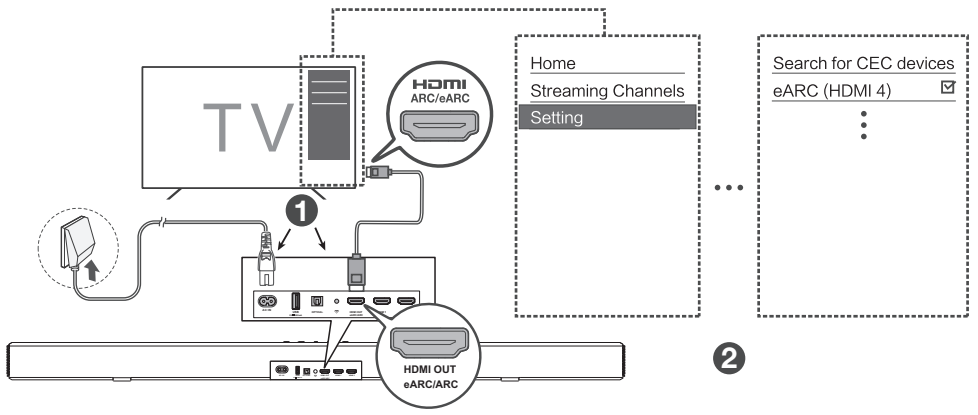
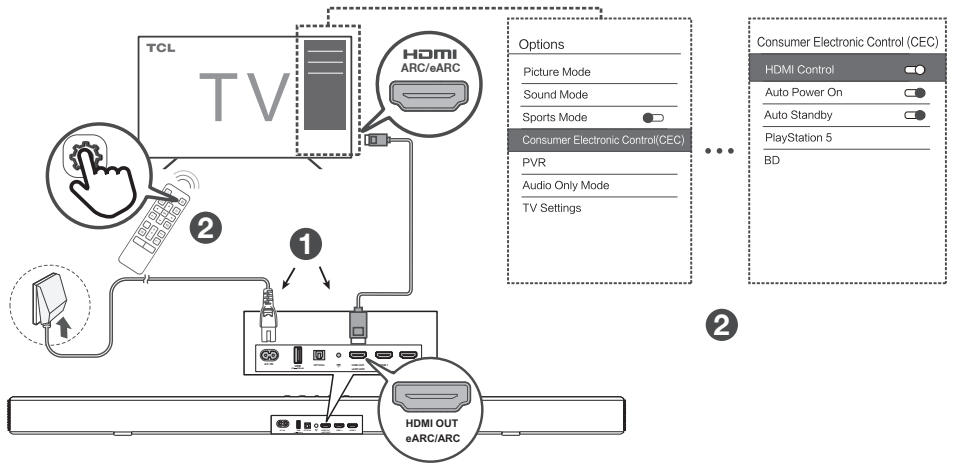

7b



- EN** This cable is sold seperately.
- SQ** Ky kabëll shitet veçmas.
- BG** Този кабел се продава отделно.
- HR** Ovaj se kabel prodaje zasebno.
- CS** Tento kabel se prodává samostatně.
- DA** Dette kabel sælges separat.
- NL** Deze kabel wordt apart verkocht.
- ET** Seda kaablit müüakse eraldi.
- FI** Kaapeli myydään erikseen.
- CCC** Ce câble est vendu séparément.
- DE** Dieses Kabel wird separat verkauft.
- EL** Αυτό το καλώδιο πωλείται ξεχωριστά.
- HU** Ezt a kábelt külön értékesítik.
- IT** Questo cavo è venduto separatamente.
- LV** Šis kabelis tiek pārdots atsevišķi.
- LT** Šis kabelis parduodamas atskirai.
- MK** Овој кабел се продава одделно.
- NO** Denne kabelen selges separat.
- PL** Ten kabel jest sprzedawany osobno.
- PT** Este cabo é vendido separadamente.
- RO** Acest cablu este vândut separat.
- RU** Этот кабель продается отдельно.
- SR** Ovaj kabel se prodaje odvojeno.
- SK** Tento kábel sa predáva osobitne.
- SL** Ta kabel se prodaja ločeno.
- ES** Este cable se vende separadamente.
- SV** Denna kabel säljs separat.
- TR** Bu kablo ayrı satılır.
- UA** Цей кабель продається окремо.

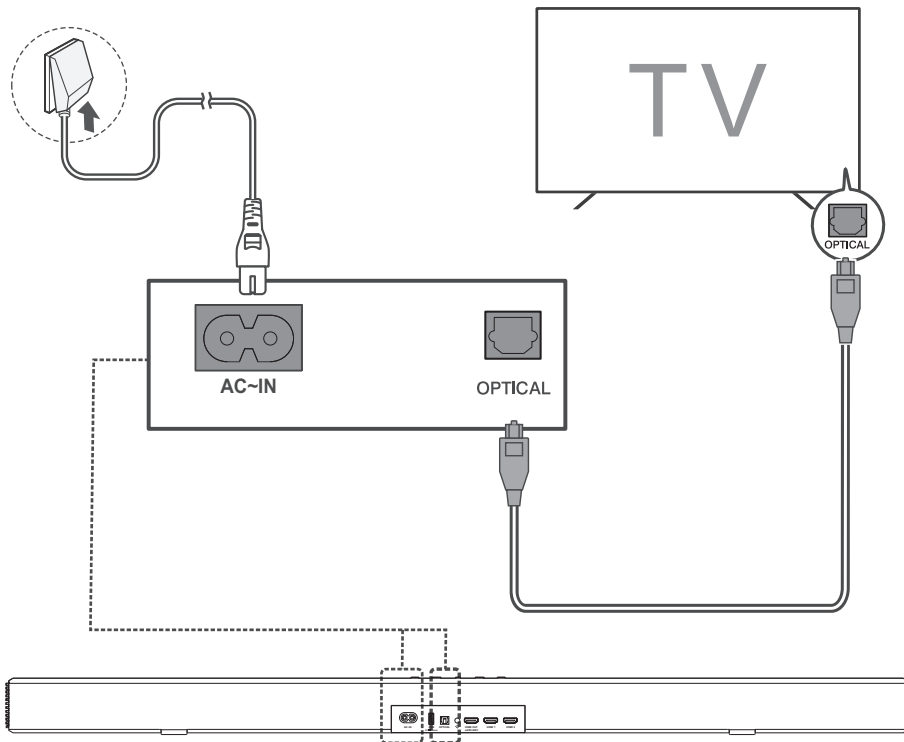

7c

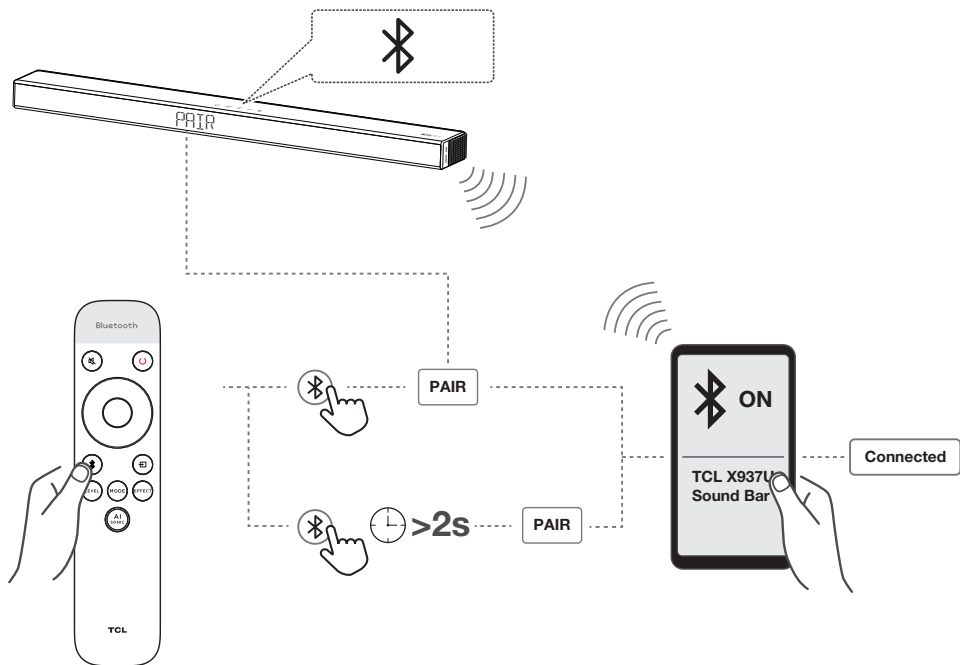

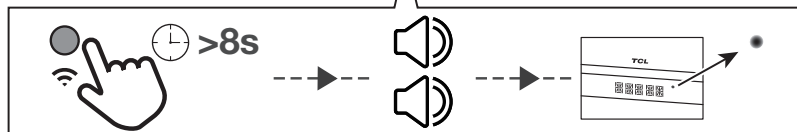

iOS



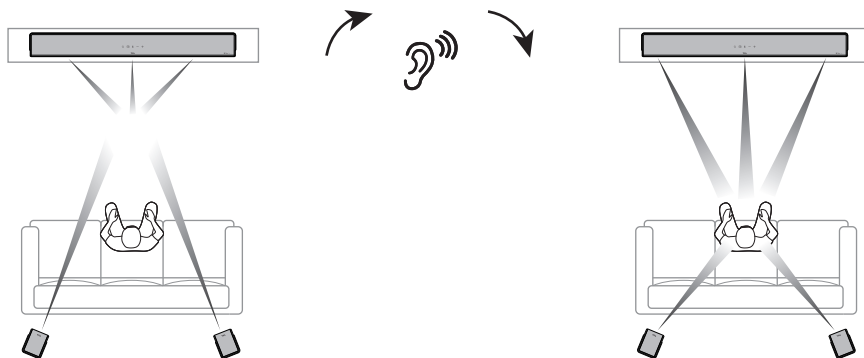
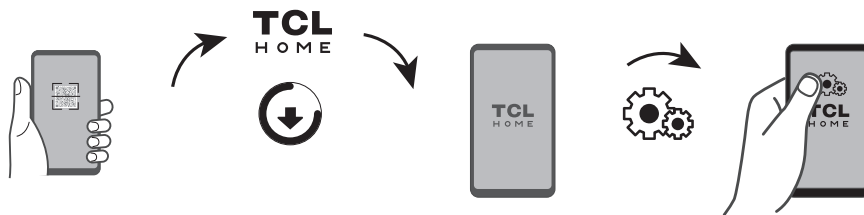

Trademarks



To control this AirPlay 2-enabled speaker, iOS 11.4 or later is required. Apple, AirPlay, iPad, iPad Air, iPad Pro, and iPhone are trademarks of Apple Inc., registered in the U.S. and other countries.



Use your phone, tablet or computer as a remote control for Spotify. Go to spotify.com/connect to learn how. The Spotify Software is subject to third party licenses found here: www.spotify.com/connect/third-party-licenses.



Google and Chromecast built-in are trademarks of Google LLC.



Google and works with Ok Google are trademarks of Google LLC.



Amazon, Alexa and all related logos are trademarks of Amazon.com, Inc. or its affiliates.

COMPATIBLE WITH



Dolby, Dolby Atmos, Dolby Vision, and the double-D symbol are registered trademarks of Dolby Laboratories Licensing Corporation. Manufactured under license from Dolby Laboratories. Confidential unpublished works. Copyright © 2012-2022 Dolby Laboratories. All rights reserved.



The Bluetooth® word mark and logos are registered trademarks owned by Bluetooth SIG, Inc. and any use of such marks by TTE Corporation is under license. Other trademarks and trade names are those of their respective owners.



For DTS patents, see <http://patents.dts.com>. Manufactured under license from DTS, Inc. (for companies headquartered in the U.S./Japan/Taiwan) or under license from DTS Licensing Limited (for all other companies). DTS, DTS:X, the DTS:X logo, DTS, DTS Play-Fi, Play-Fi and the DTS Play-Fi and Play-Fi logos are registered trademarks or trademarks of DTS, Inc. in the United States and other countries. © 2022 DTS, Inc. ALL RIGHTS RESERVED.



The Adopted Trademarks HDMI, HDMI High-Definition Multimedia Interface, HDMI trade dress and the HDMI Logos are trademarks or registered trademarks of HDMI Licensing Administrator, Inc. in the United States and other countries.

**WE ARE
READY TO
HELP** contact us first
with any questions



TCL SUPPORT:
www.tcl.com
