



# CREATOR™

# 3 IN 1

31129



3 in 1  
3 en 1  
3 em 1  
3 az 1-ben  
Trīs vienā  
3 合 1

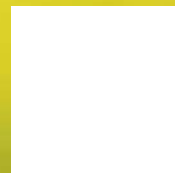



Check for compatibility  
Kompatibilität prüfen  
Vérifier la compatibilité  
Controla la compatibilitat  
Comprueba tu compatibilidad  
Verificar a compatibilidade  
Ellenőrizd a kompatibilitást  
Pārbaudīt saderību  
检查兼容性

[LEGO.com/devicecheck](https://LEGO.com/devicecheck)

# 乐高®拼搭指引



LEGO® Building Instructions



Download on the  
App Store



GET IT ON  
Google Play



腾讯应用宝  
安卓应用商店

Apple and the Apple logo are trademarks of Apple Inc.  
Google Play and the Google Play logo are trademarks of Google LLC.  
Tencent and the Tencent logo are trademarks of Tencent Inc.



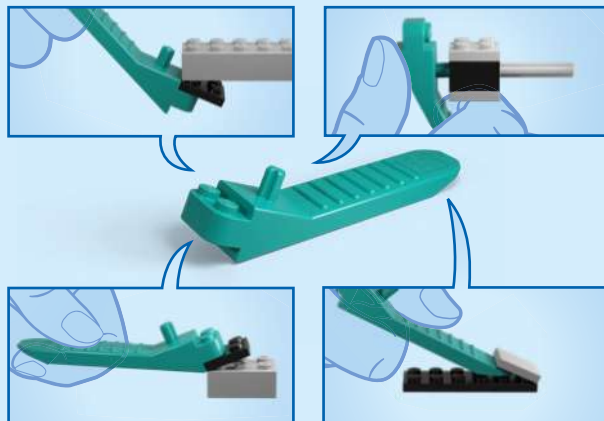

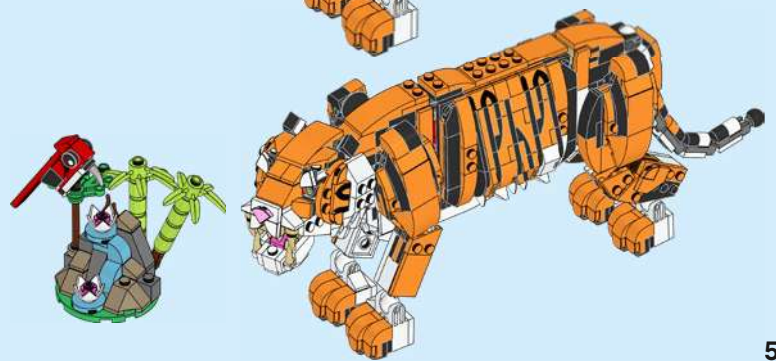
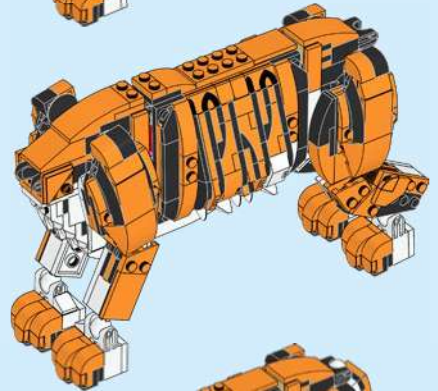
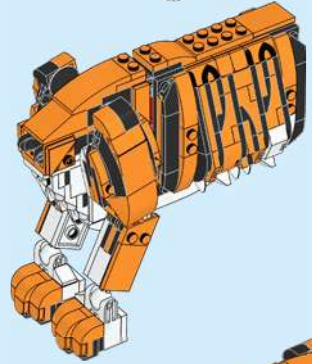
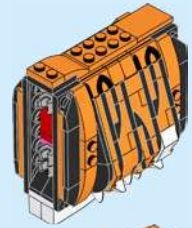
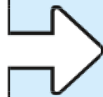
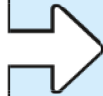
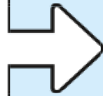
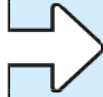

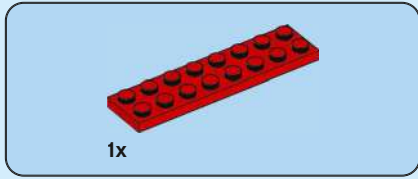
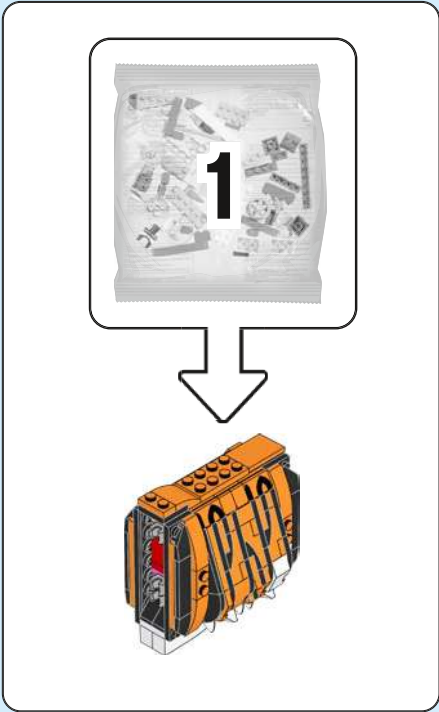
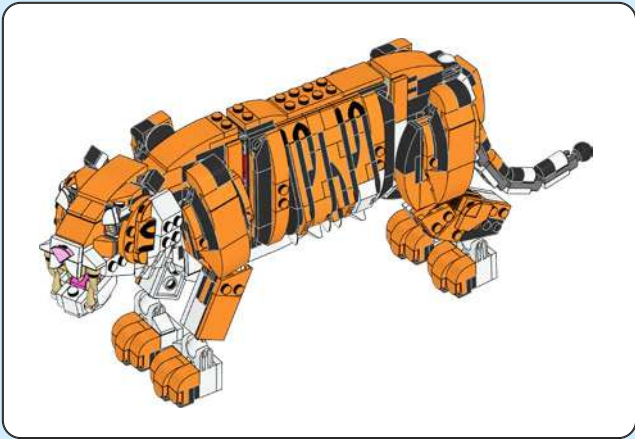

1

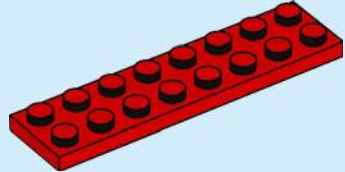

2

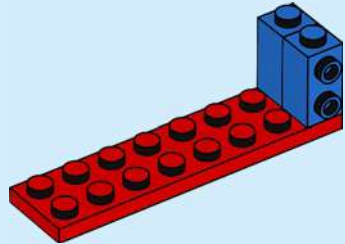



3

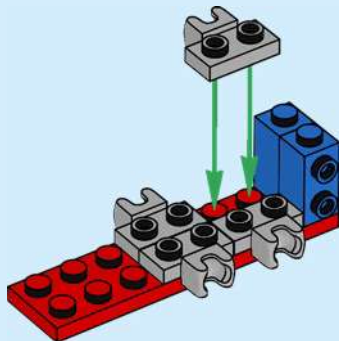

4

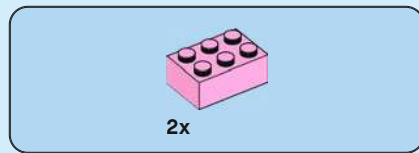
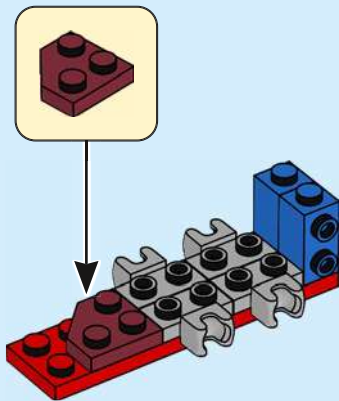

5

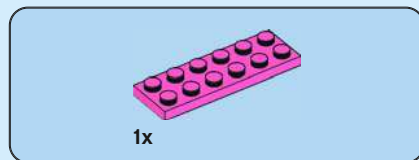
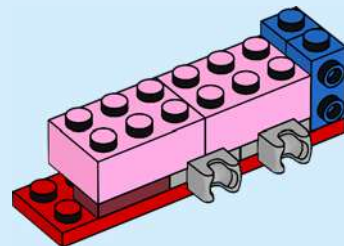

6

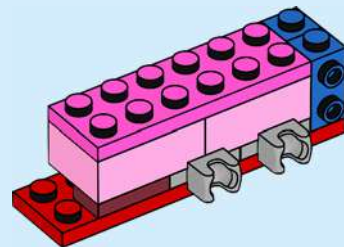



2x

7

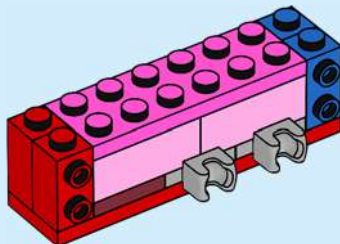

1x

8

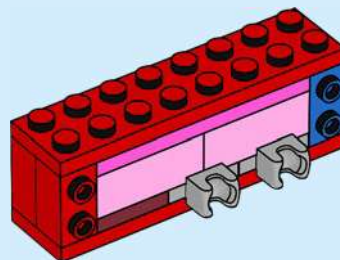

2x

9

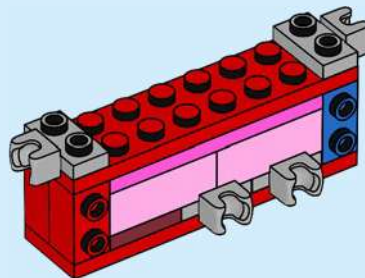





6x

10

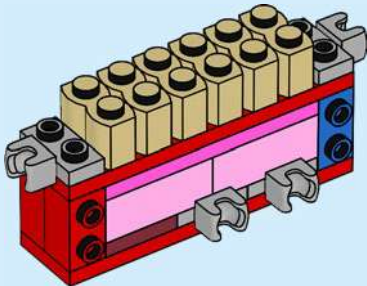

4x

11

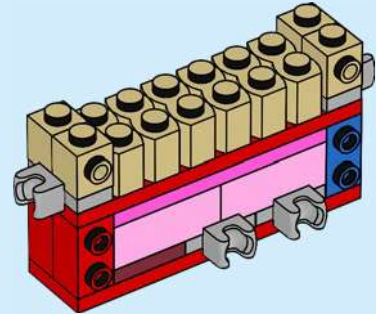

6x

12

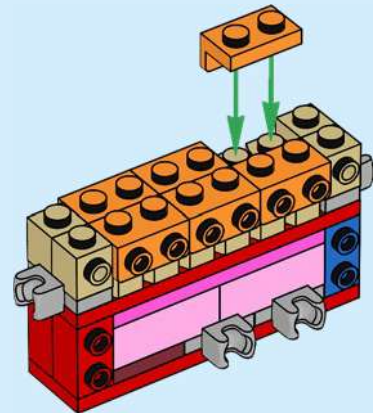

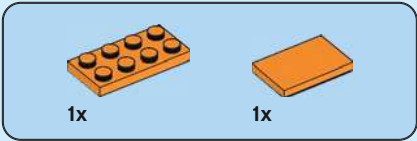

13

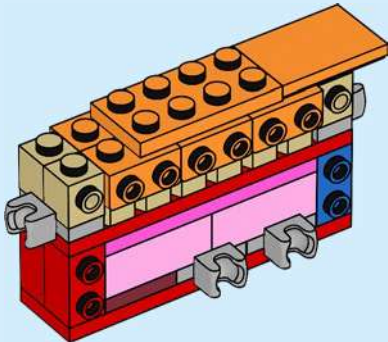

14

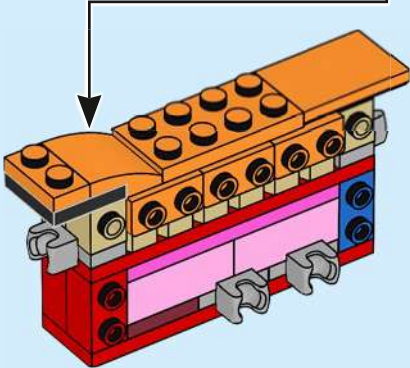

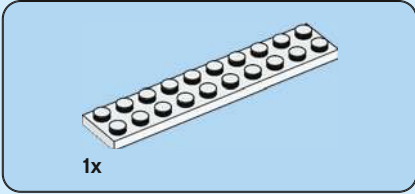
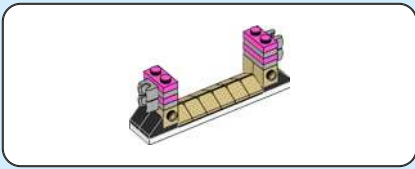

1x

15

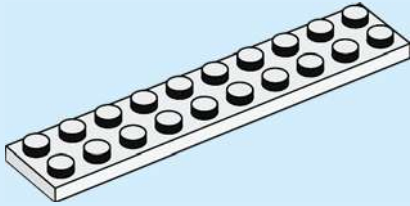

4x

16

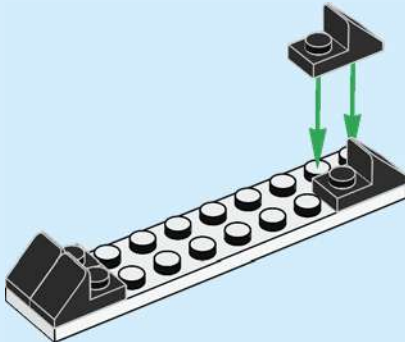

12x

17

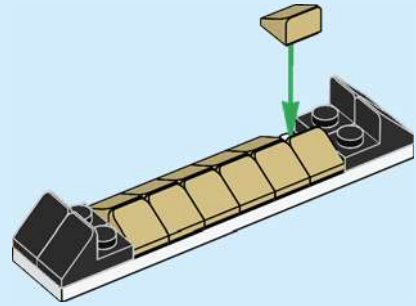

4x

18

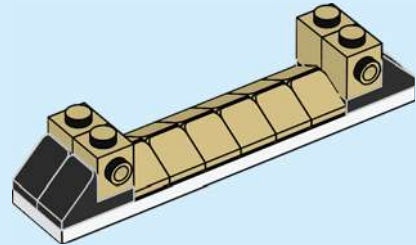



19

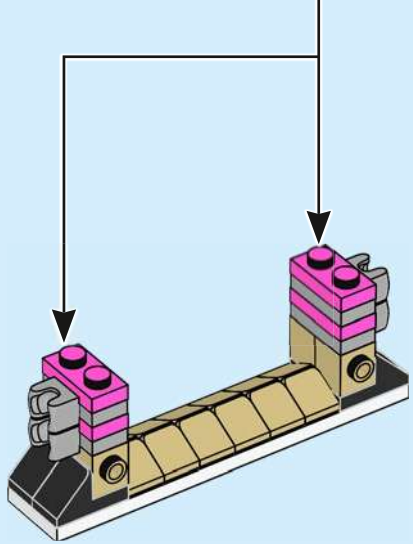
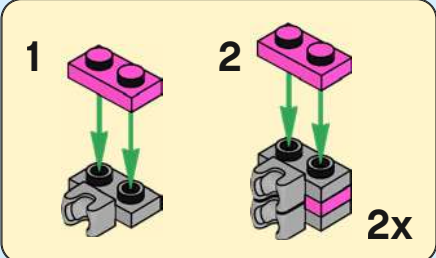

20

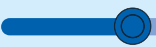
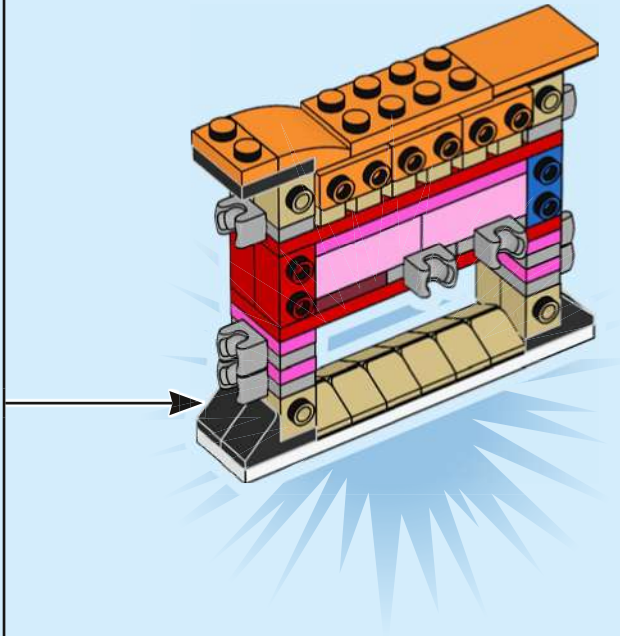

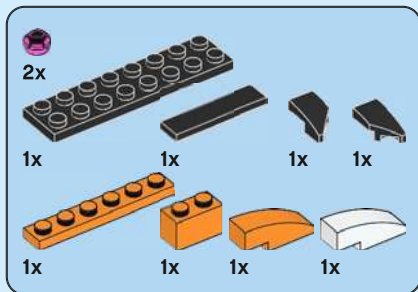

21

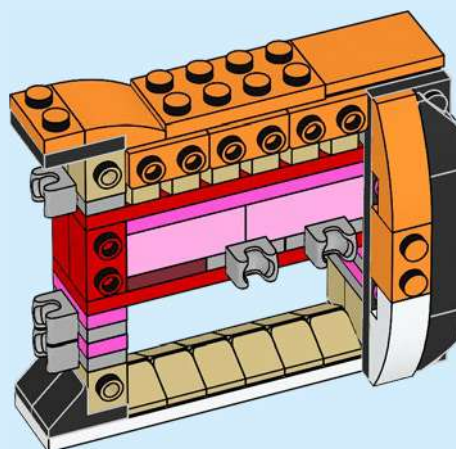
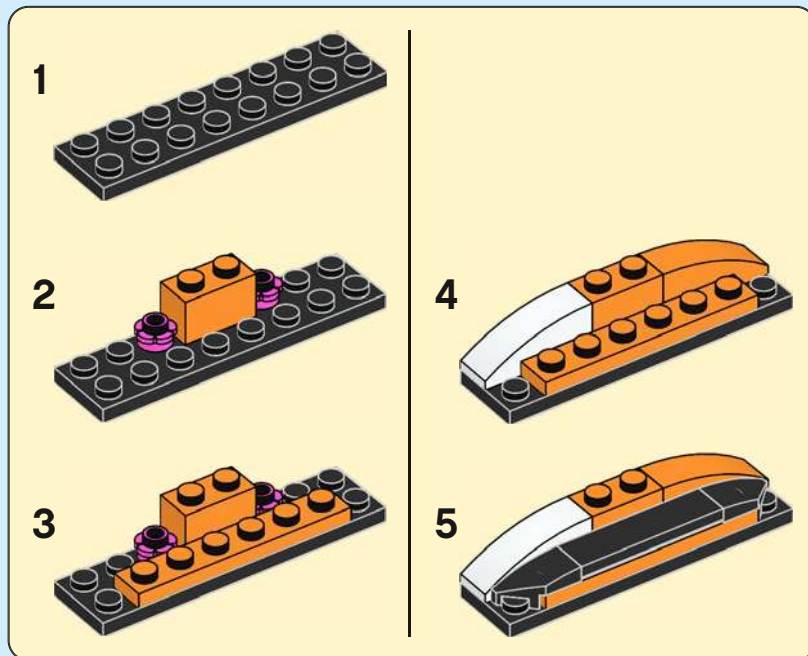



2x



2x

22

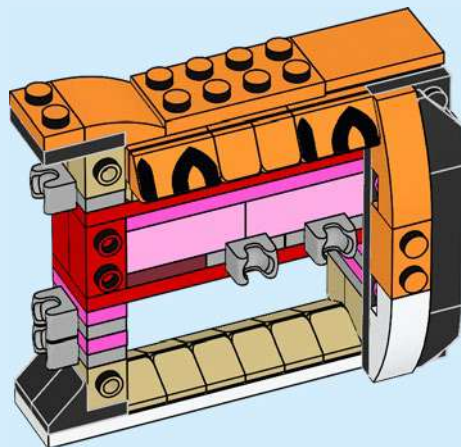

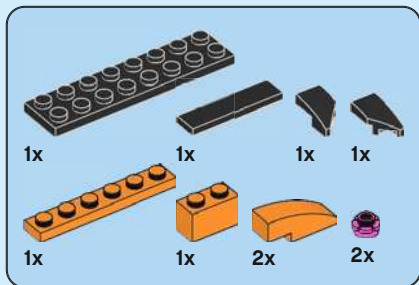

23

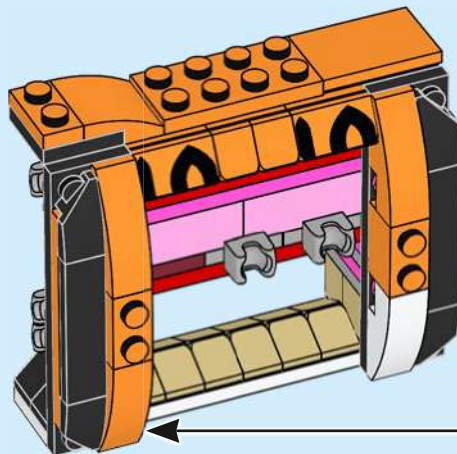
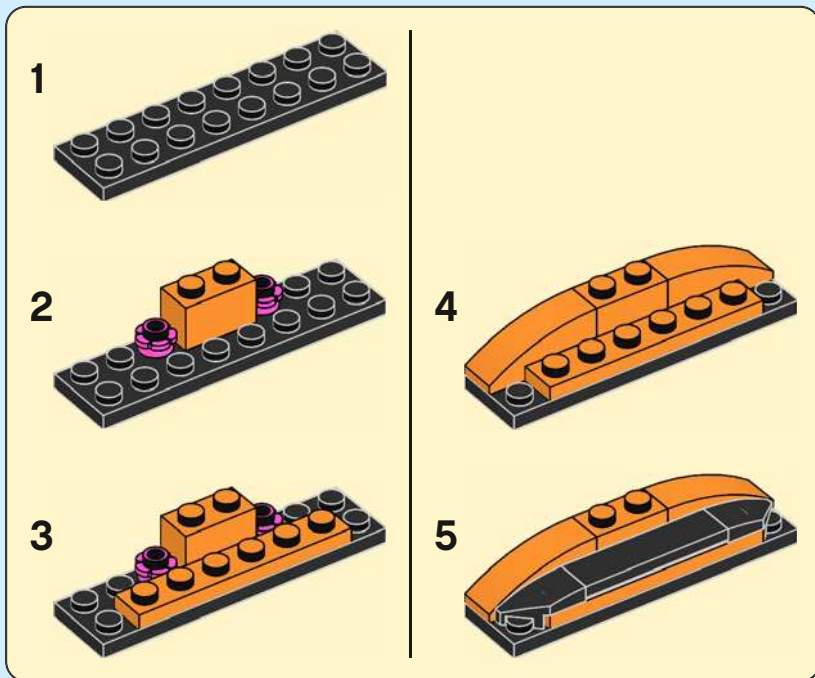

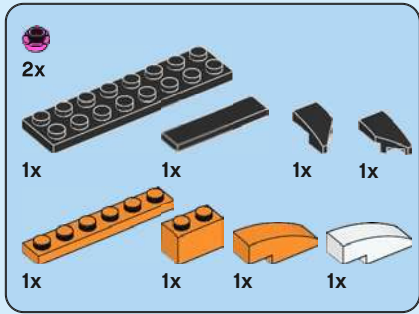

24

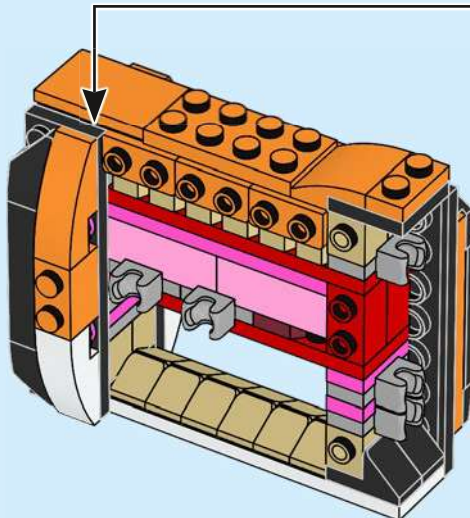
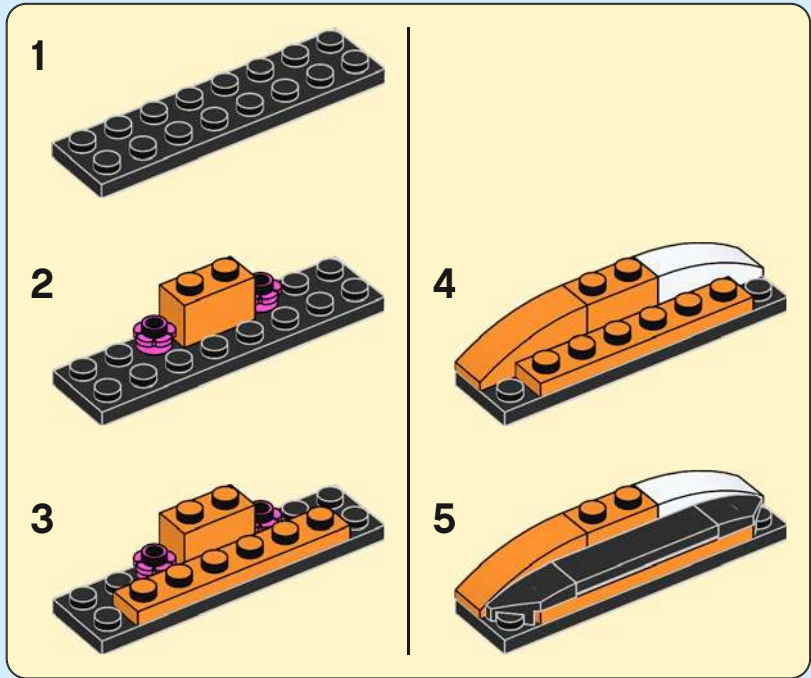





2x



2x

25

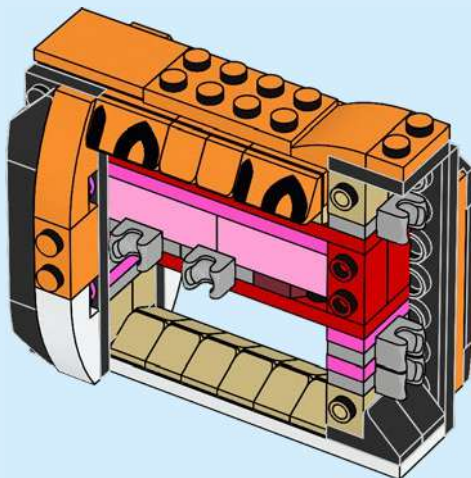

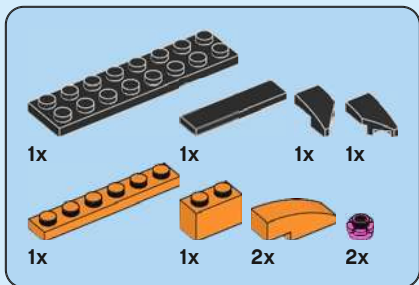

26

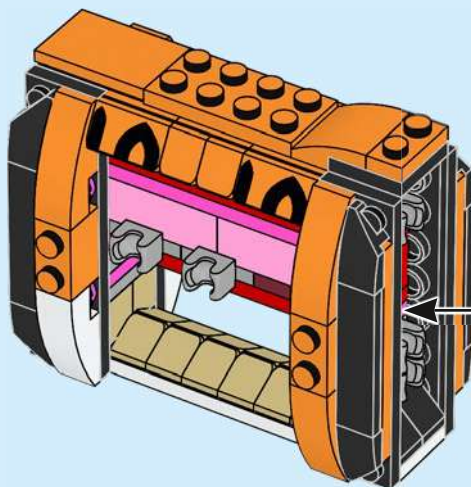
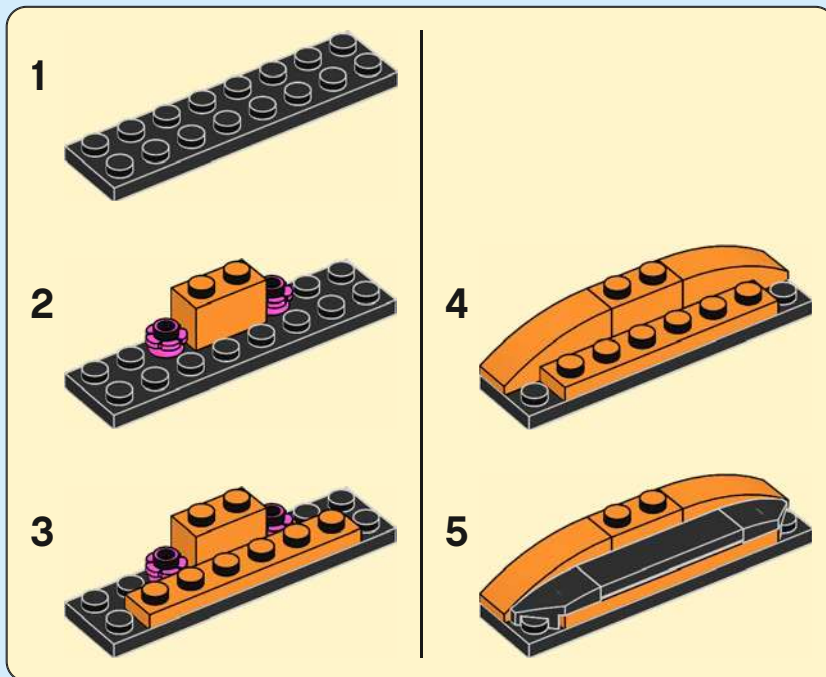



27

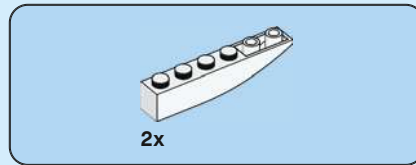
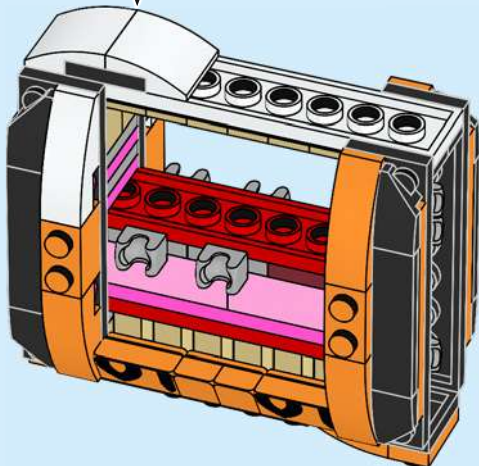
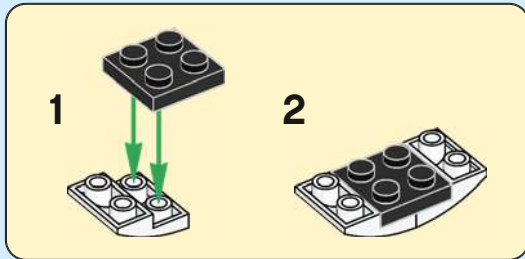

28

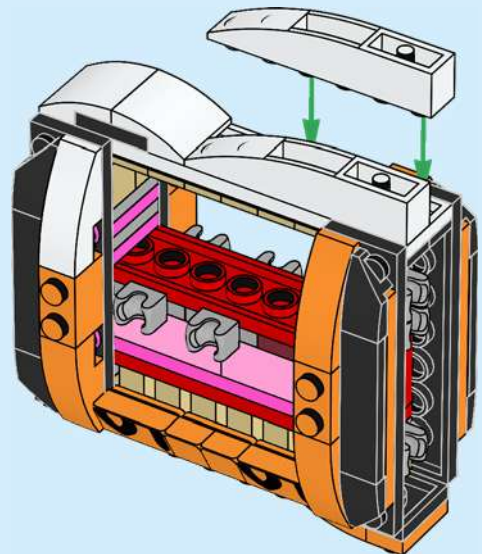

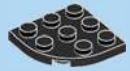
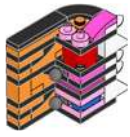

1x

29

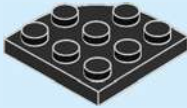

1x

30



1x



1x



1x

31



1x



1x



1x

32

1



2



3

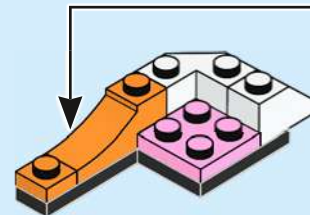
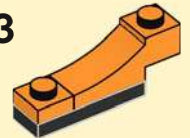



1x



1x

33

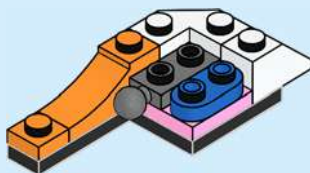

1x

34

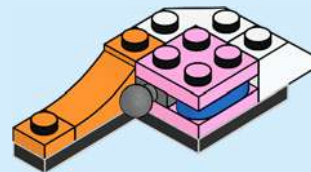

1x

35

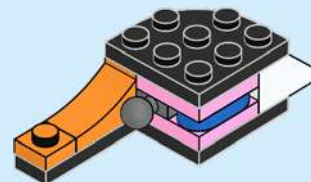

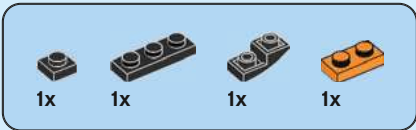

36

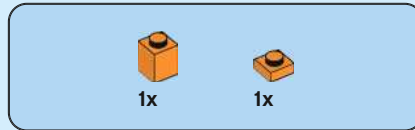
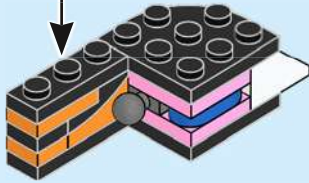
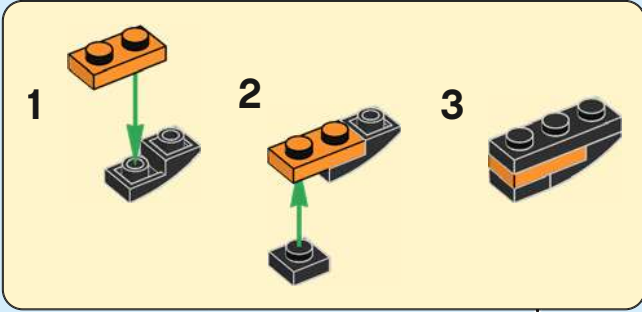

37

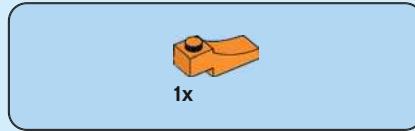
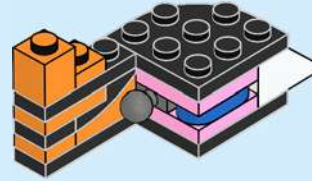

38





39



40

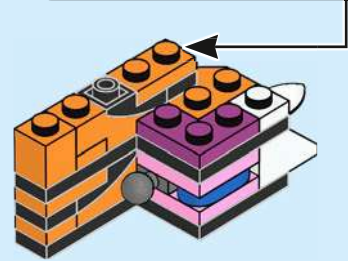
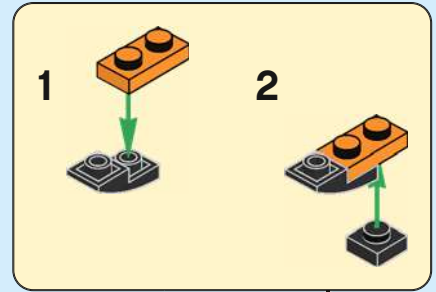

41

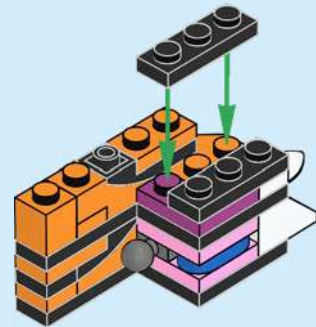

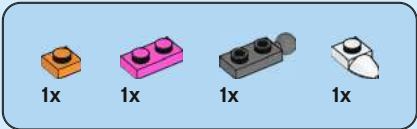

42

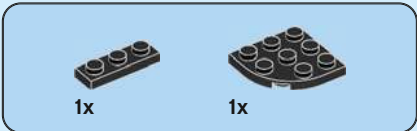

43

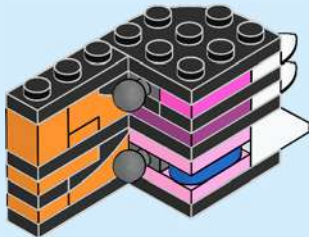

44

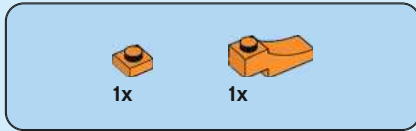
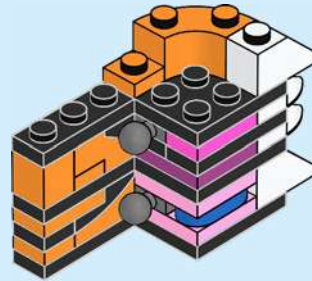

45

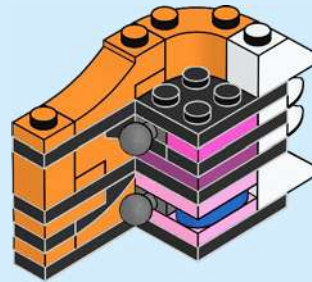



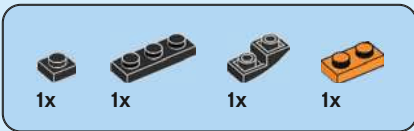

46

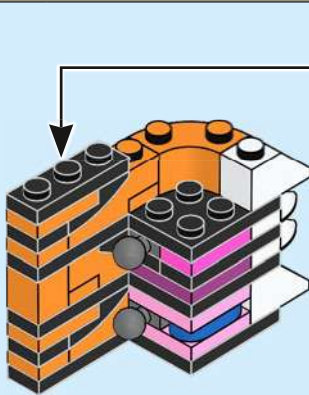
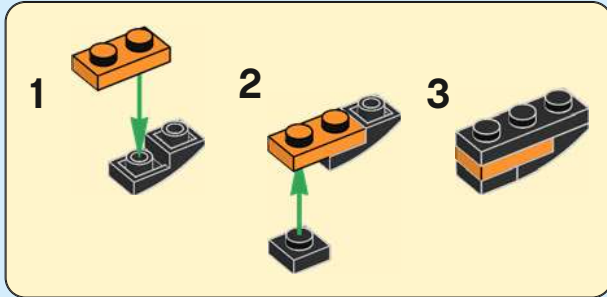

47

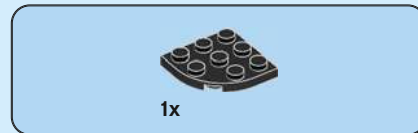

48

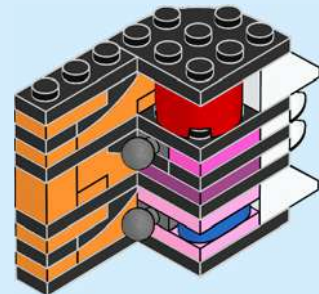

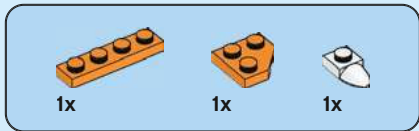

49

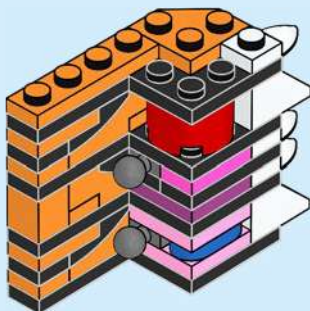

50

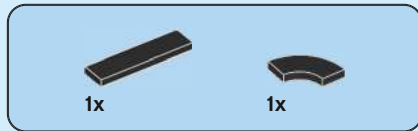
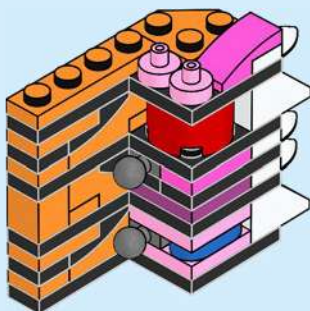

51

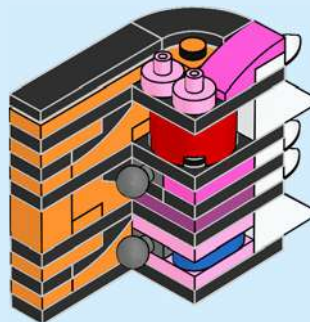

# 52

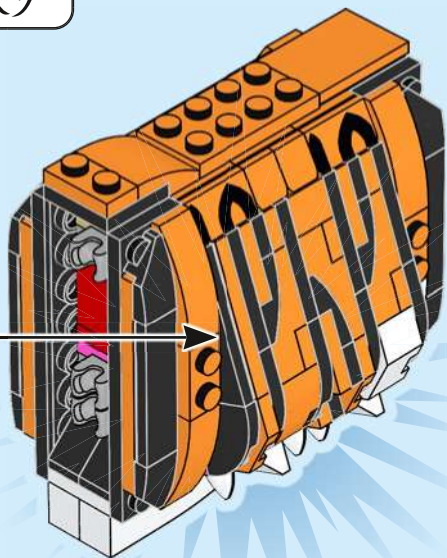

1x

# 53

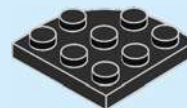

1x

# 54



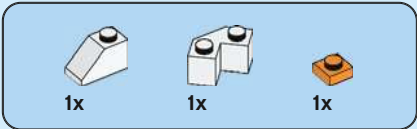

55

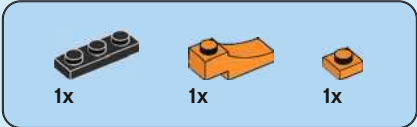
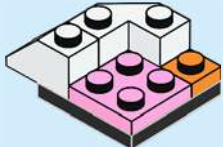

56

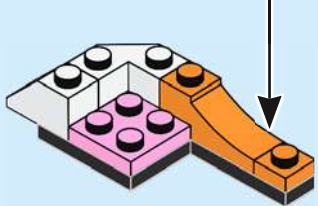
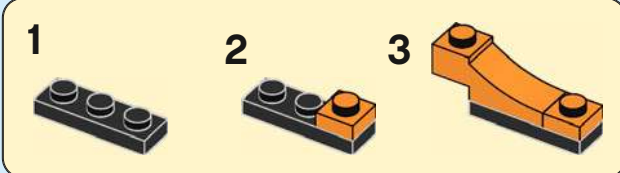

57



58



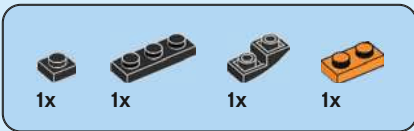

59

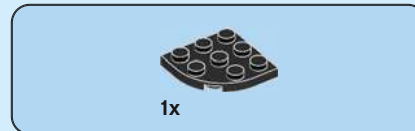
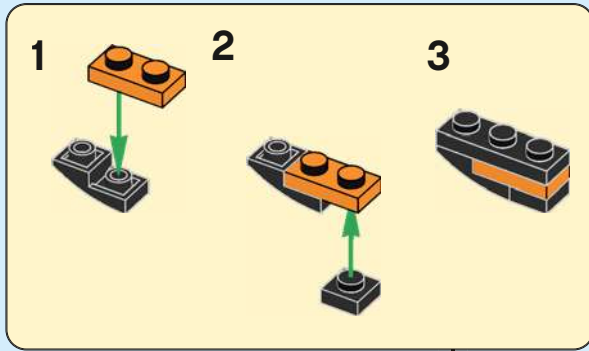

60

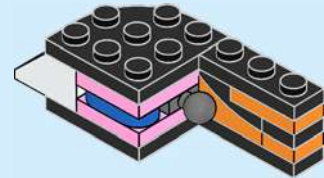

61





1x

# 62



1x



1x



1x

# 63

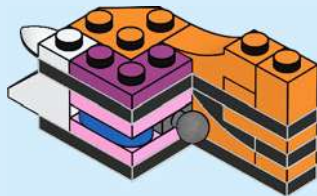

1x



1x



1x

# 64

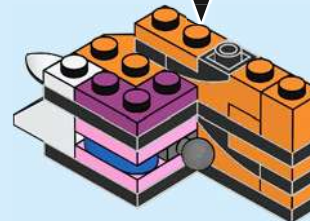
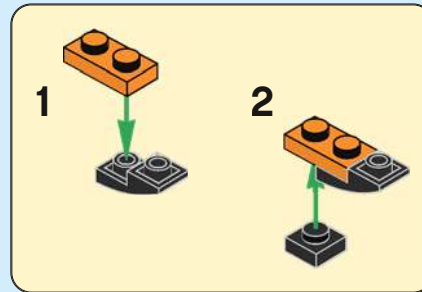



2x

# 65



1x



1x



1x



1x

# 66



1x

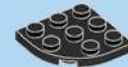

1x

# 67

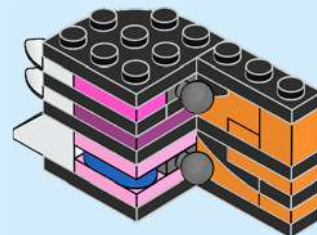

1x



1x



1x

# 68

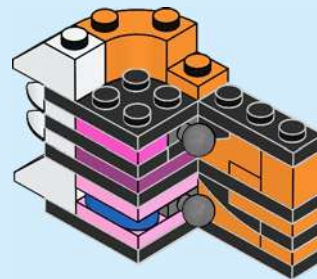

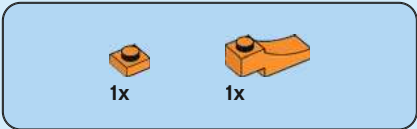

69

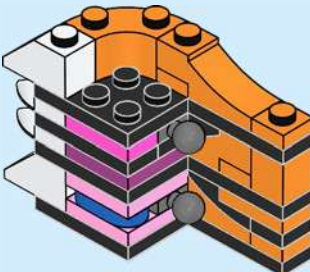

70

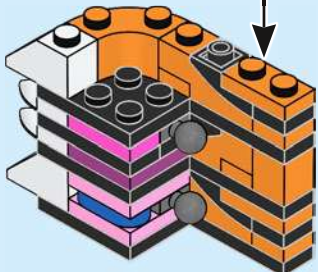
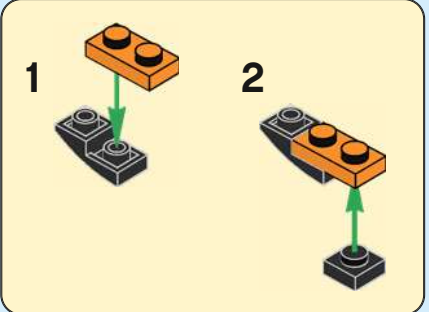





1x

# 71

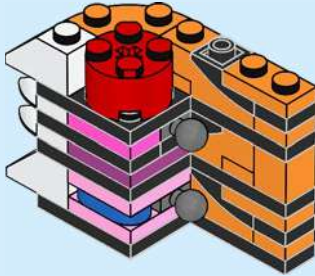

1x



1x

# 72

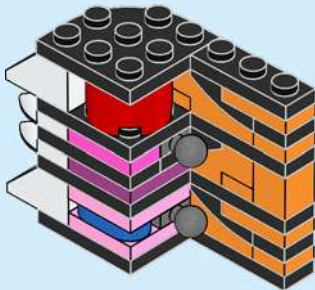

1x



1x



1x

# 73

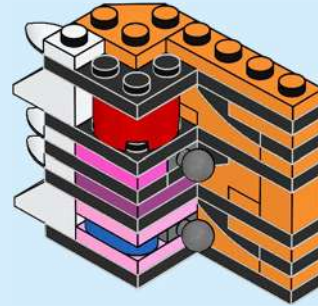

1x



2x

# 74

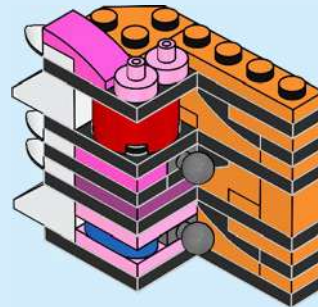

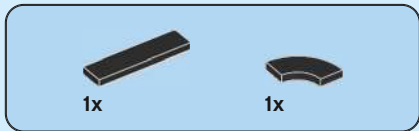

75

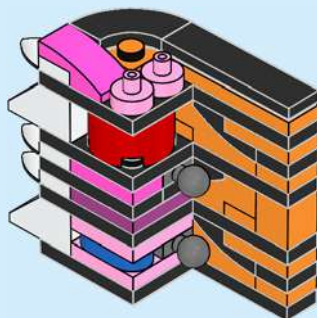

76

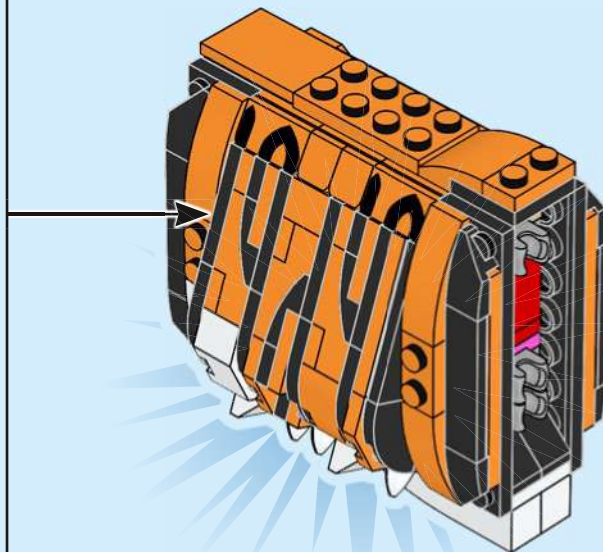

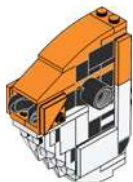
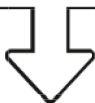

1x

77



2x

78

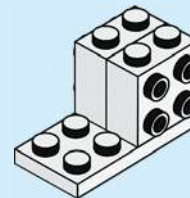



2x

# 79

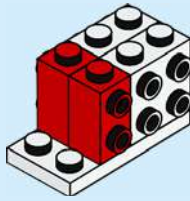

1x

# 80

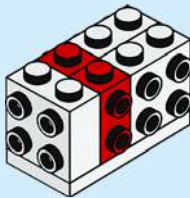

1x



2x

# 81

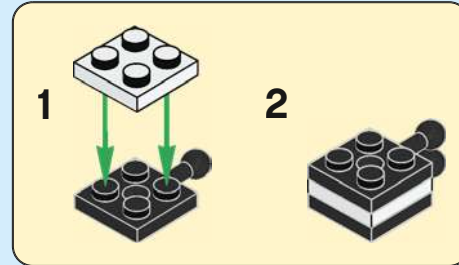



1x

# 82



1x

# 83

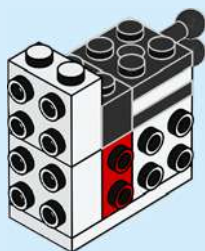

1x



2x

# 84

1



2

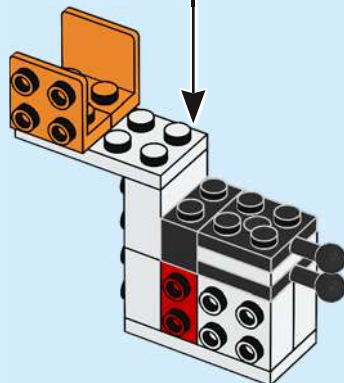
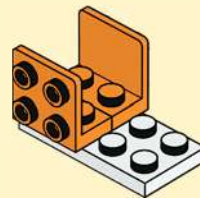

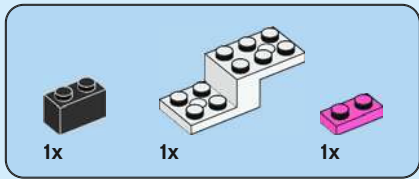

85

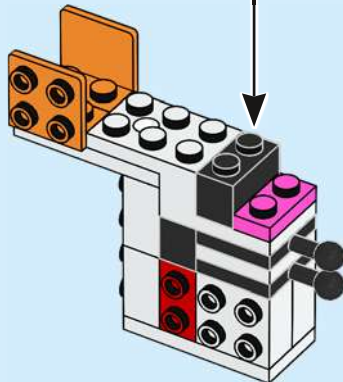
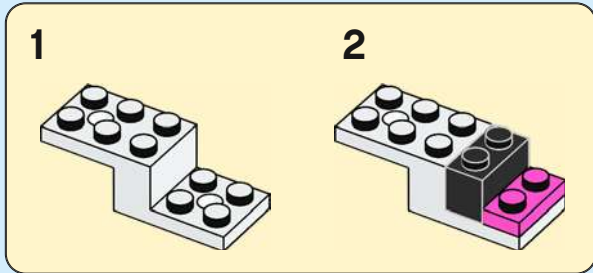

86

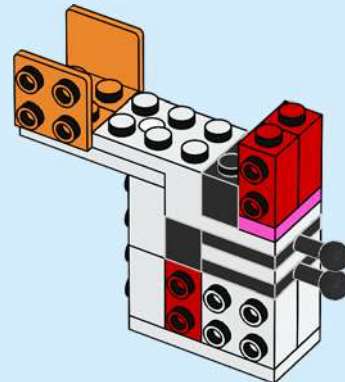

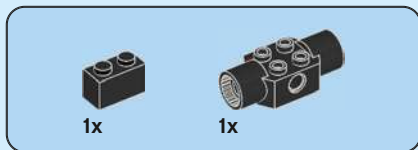

87

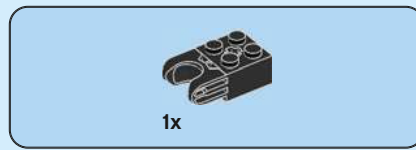
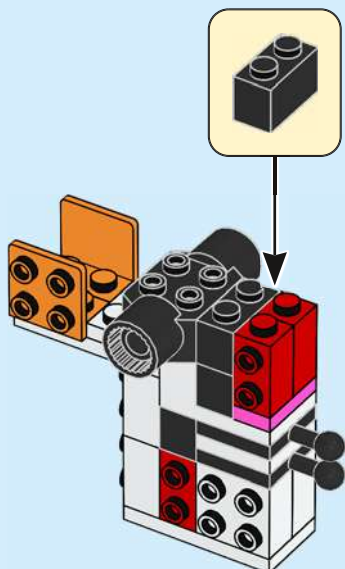

88

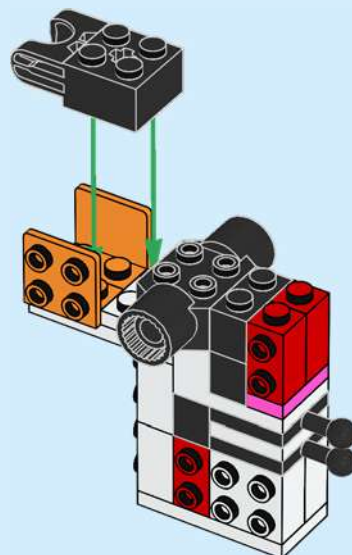

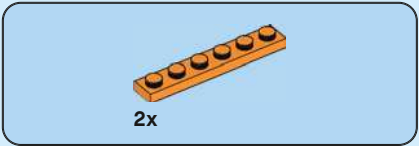

89

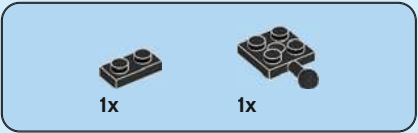
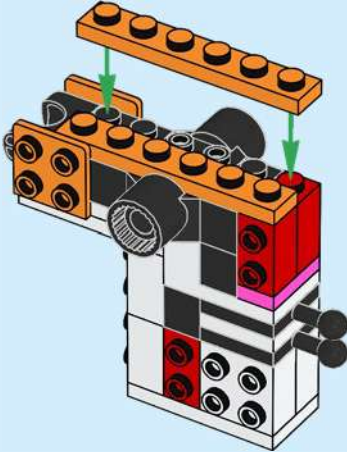

90

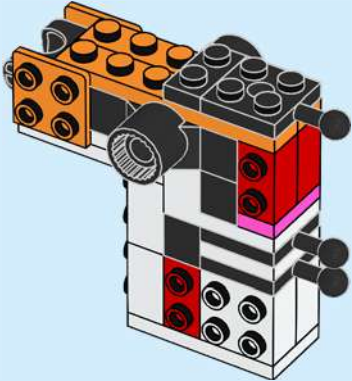





2x

91

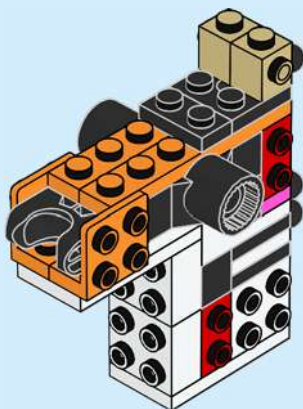

3x

92

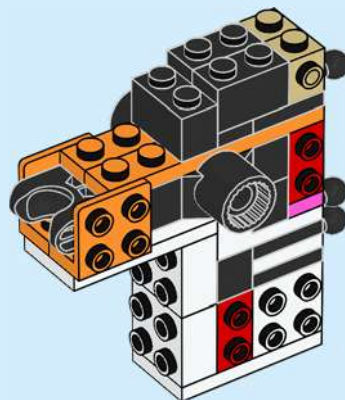



1x

93

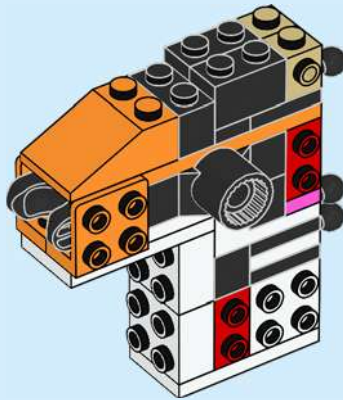

1x

94

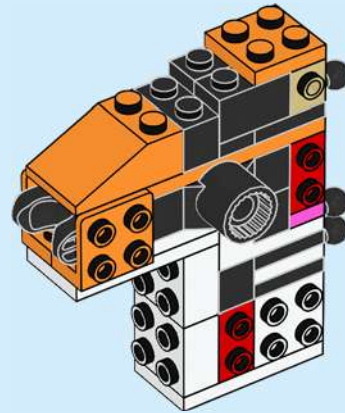

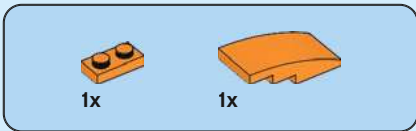

95

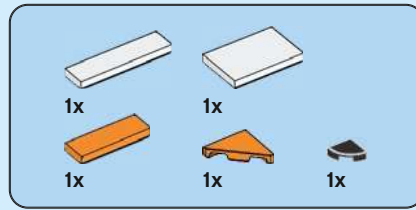
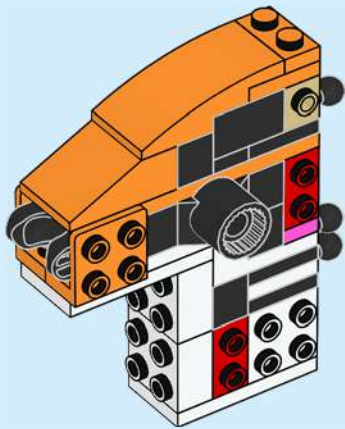

96

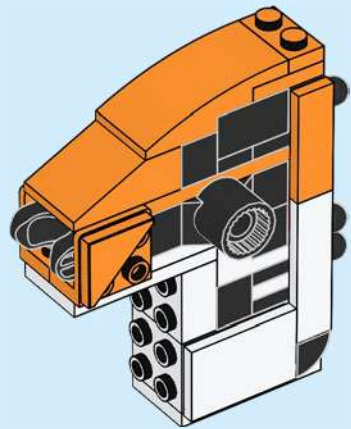

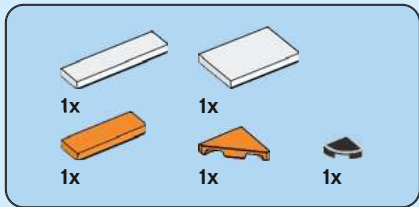

97

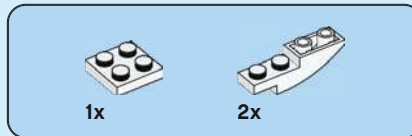
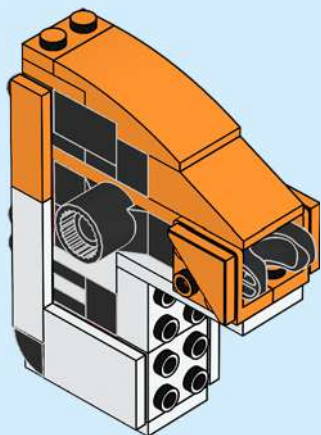

98

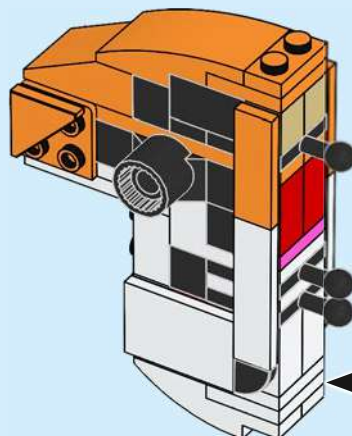
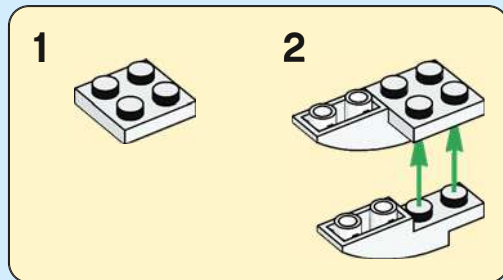

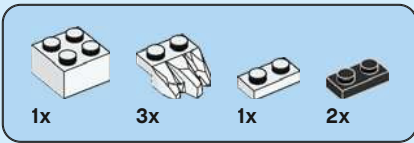

99

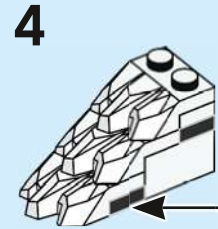
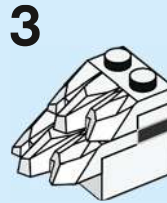
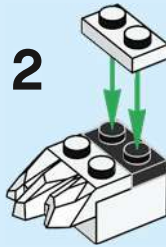
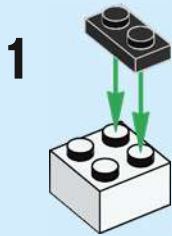

100

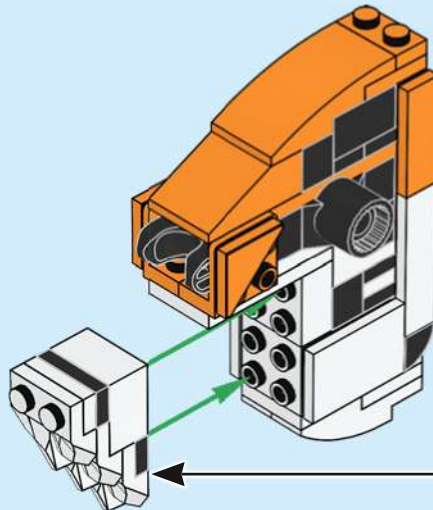

101

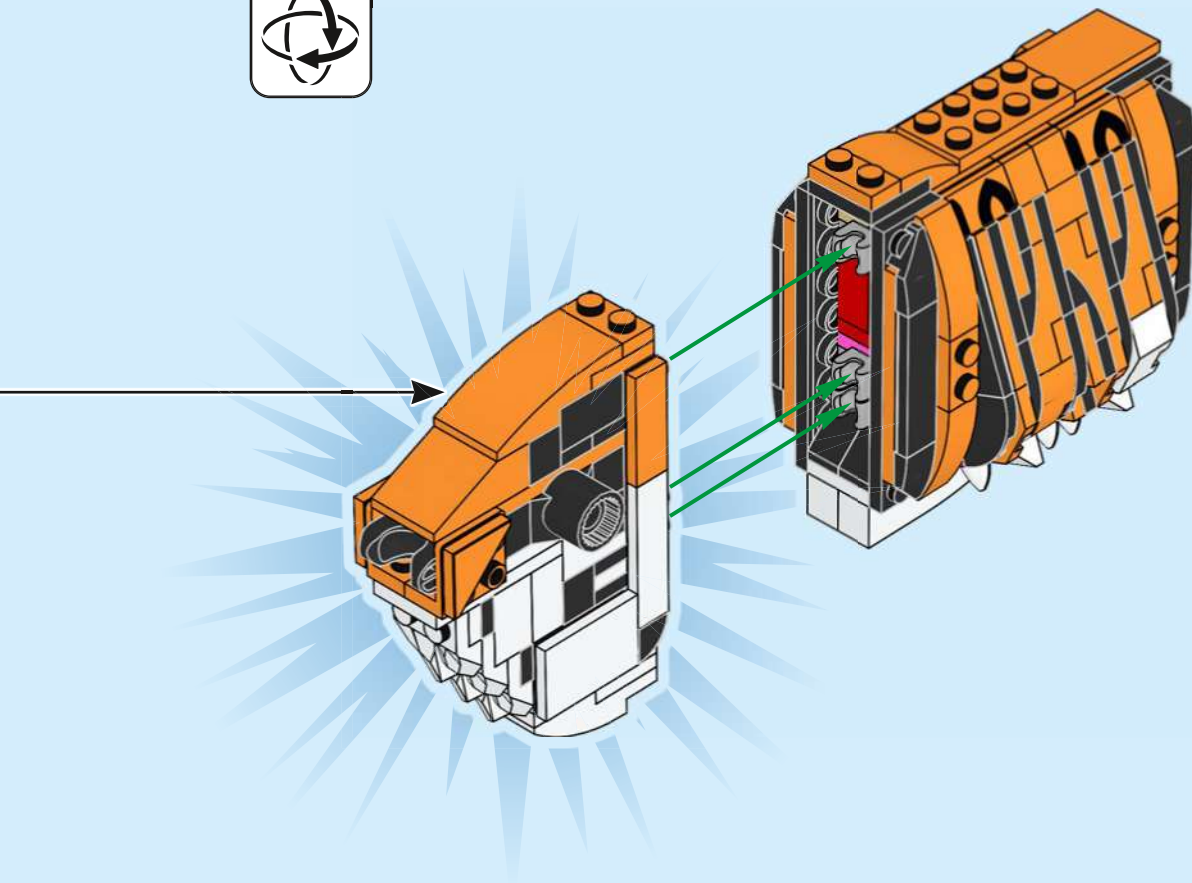

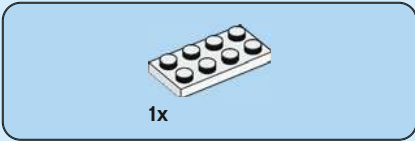
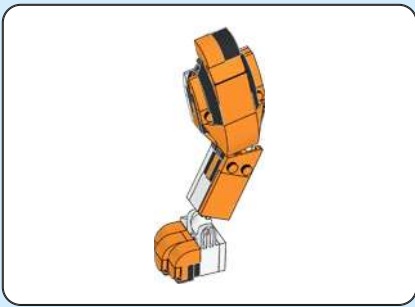

102



103

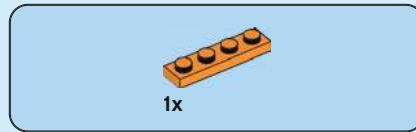

104



105

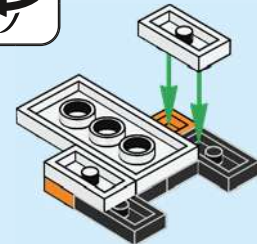

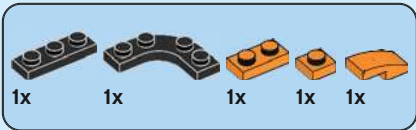

106

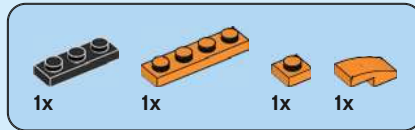
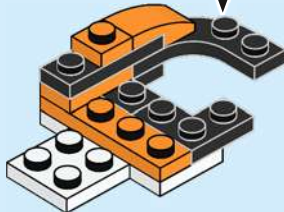
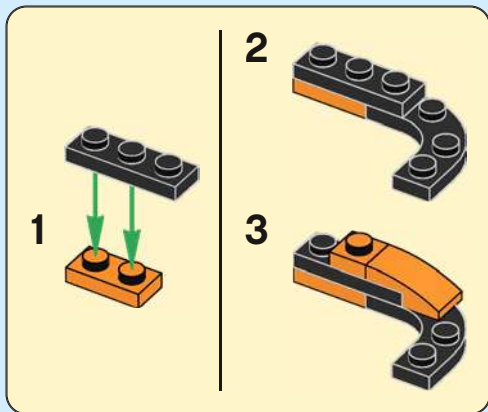

107

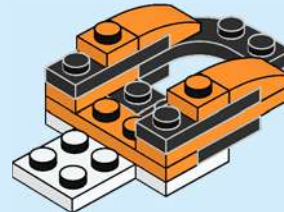
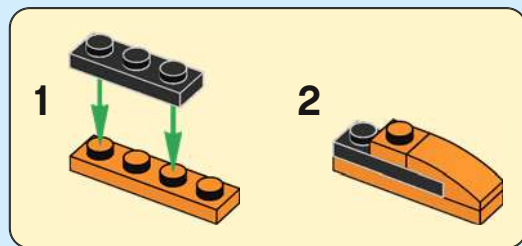





1x

# 108



1x

# 109

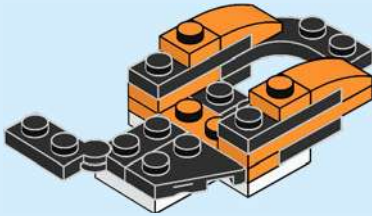

1x

# 110

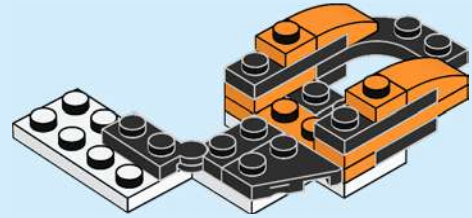

1x



1x



1x

# 111

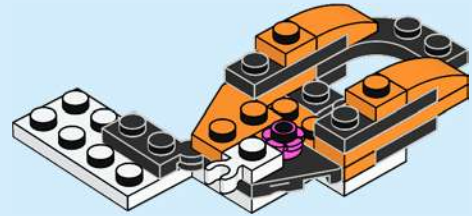



1x



1x

# 112

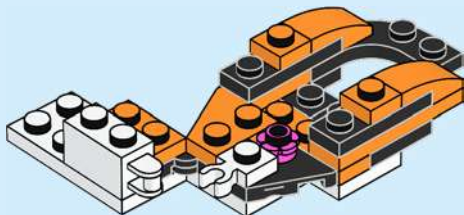

1x



1x



1x

# 113

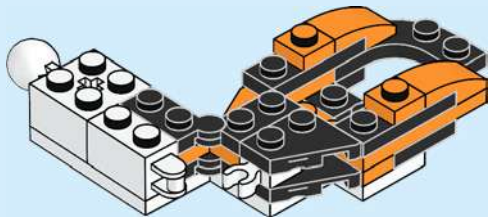

1x



1x

# 114

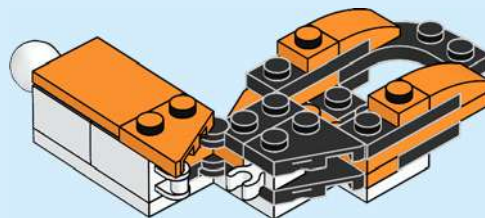



115

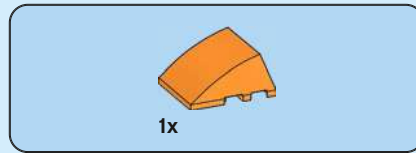
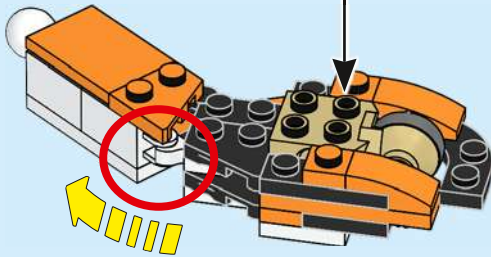

116

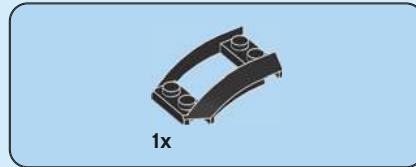
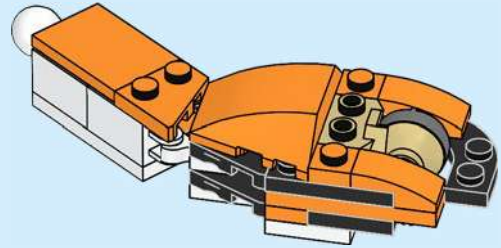

117

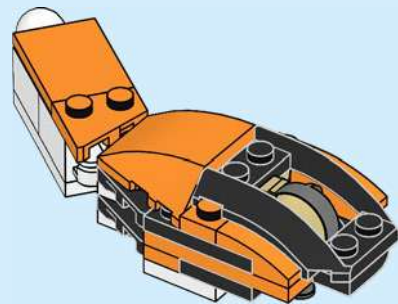



1x



1x

# 118

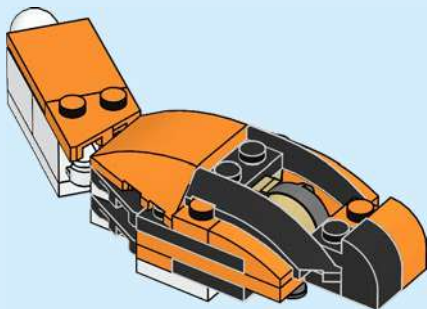

1x



1x

# 119

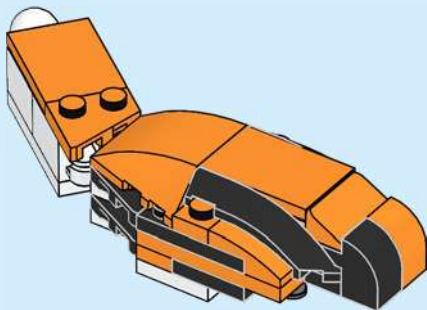

1x



2x

# 120

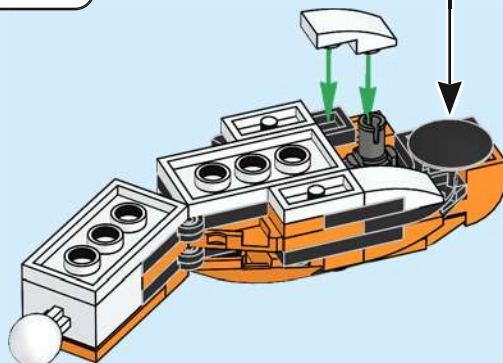



1x



1x

# 121

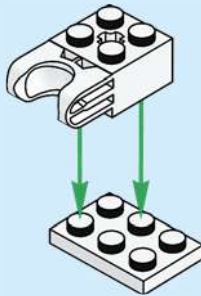

1x

# 122



1x



1x

# 123

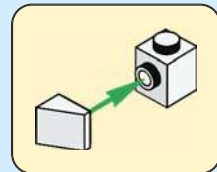



124



125

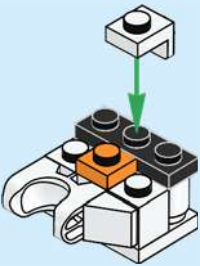

126



127





128



129

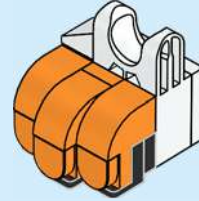

130

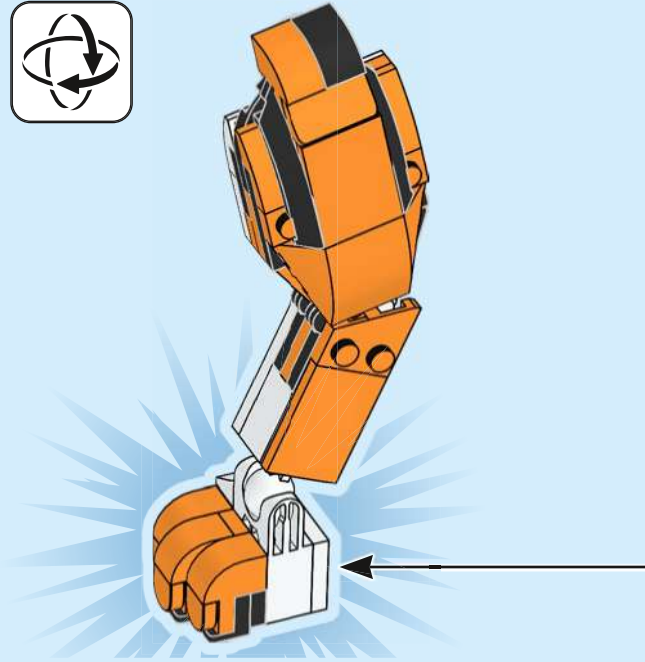

131

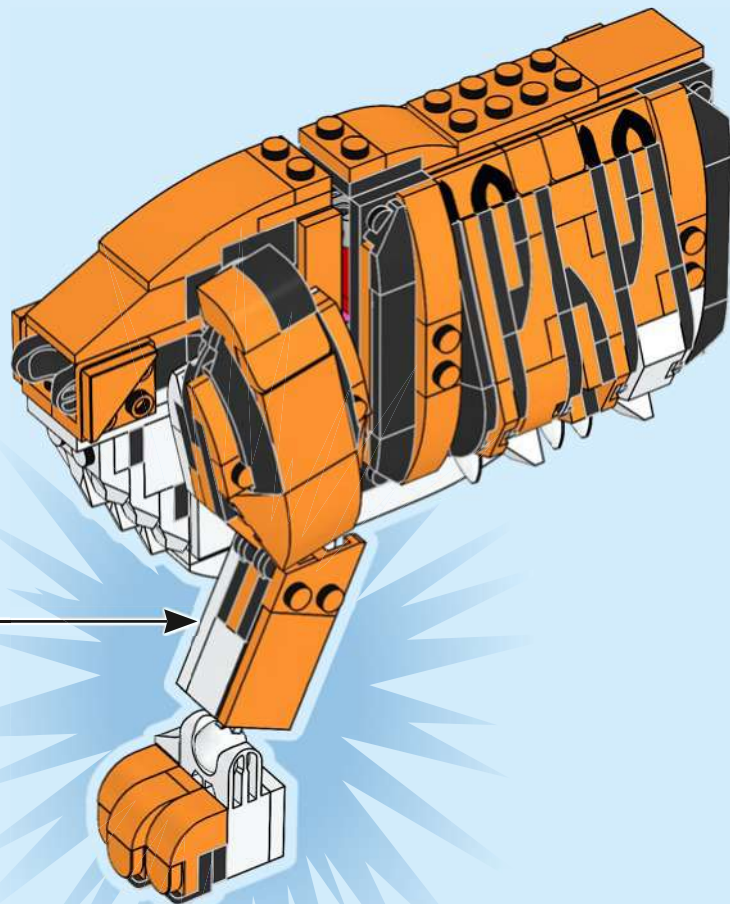



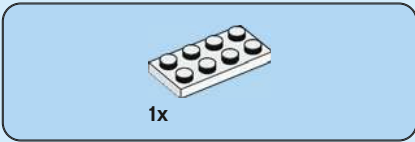
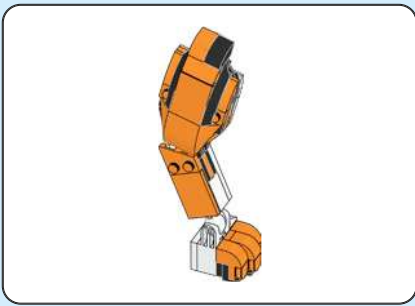

132



133

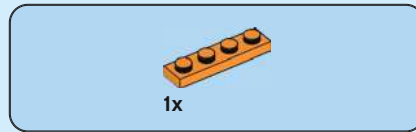

134



135

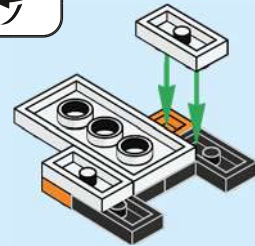
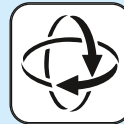

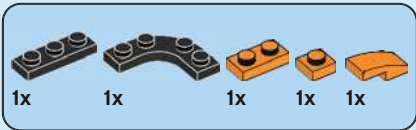

# 136

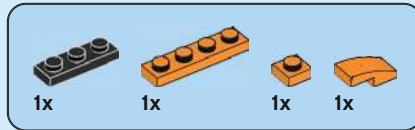
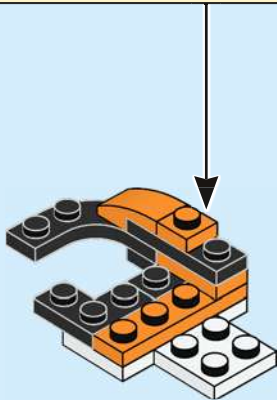
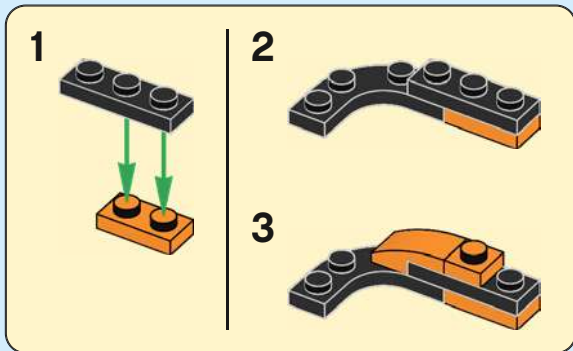

# 137

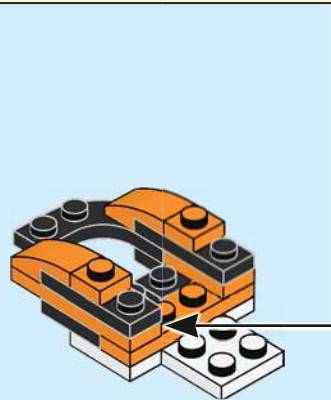
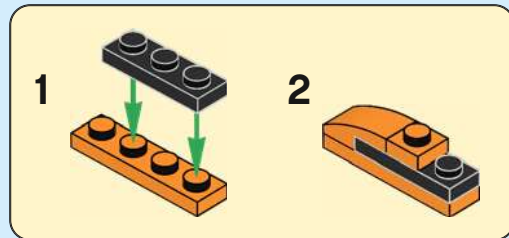



138

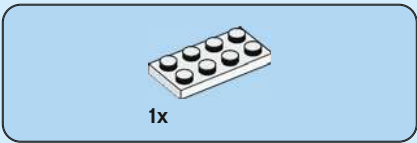

139

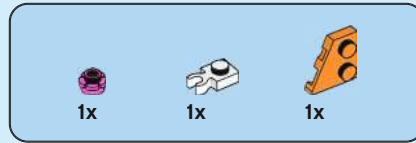
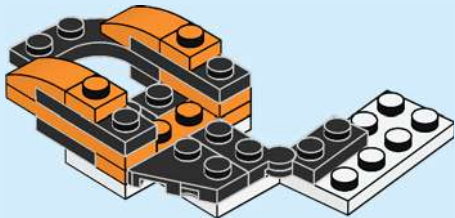

140

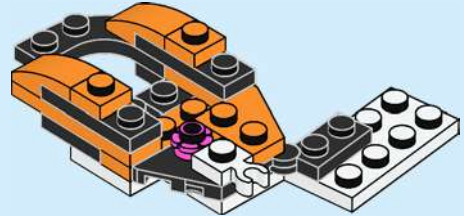

141

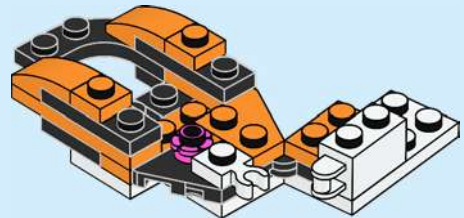



142

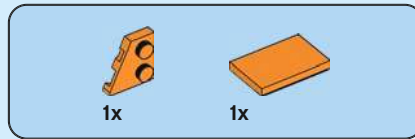
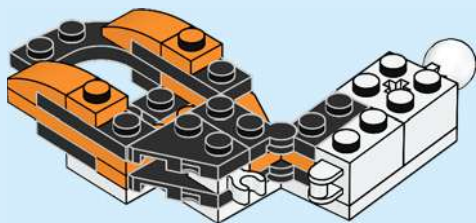

143

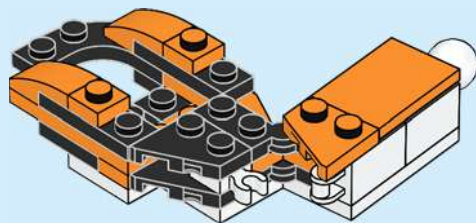

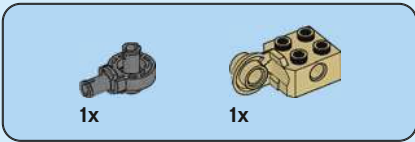

144

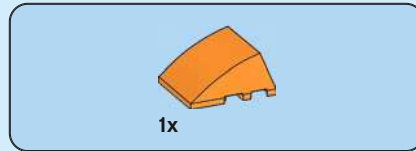
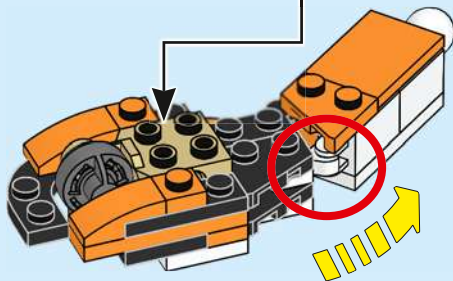

145

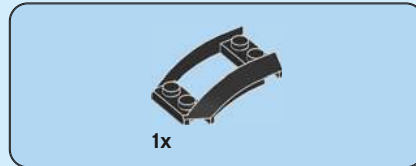
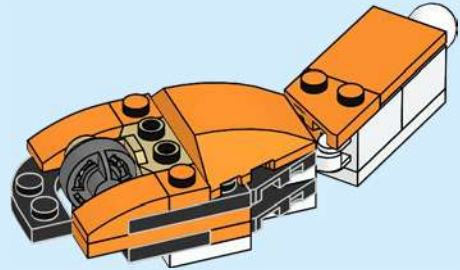

146

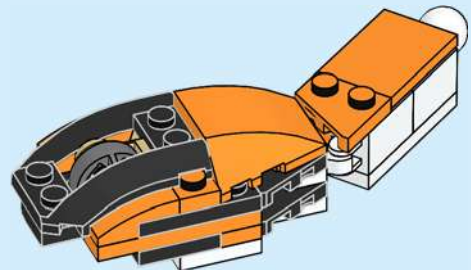



1x



1x

# 147

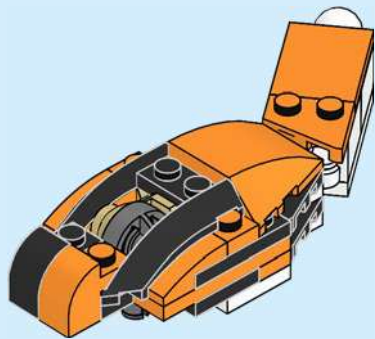

1x



1x

# 148

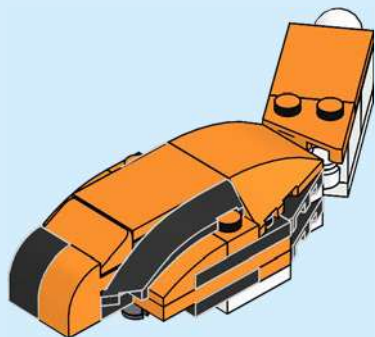

1x



2x

# 149

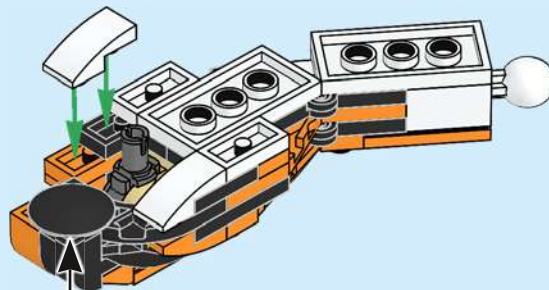

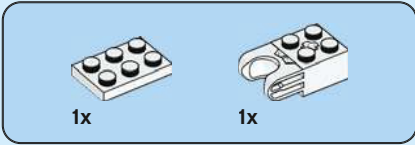

150

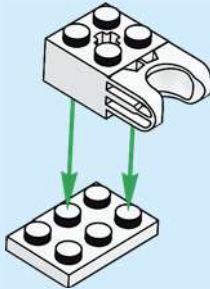

151

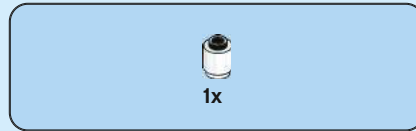
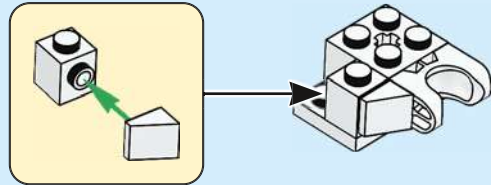

152





1x



1x

# 153



1x

# 154

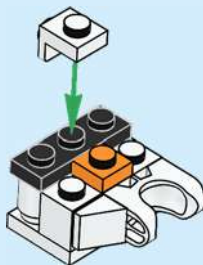

3x

# 155



3x

# 156





3x

157



158

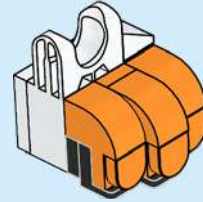

159

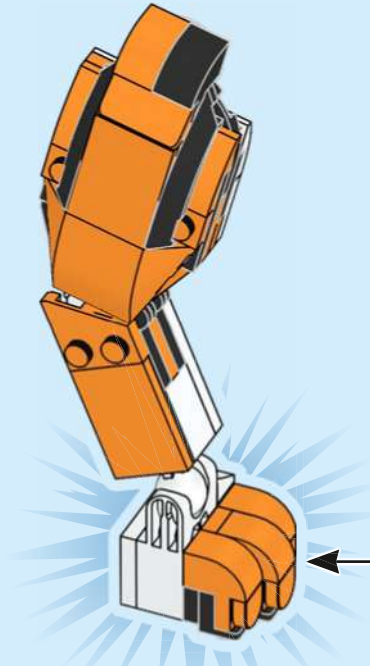

160

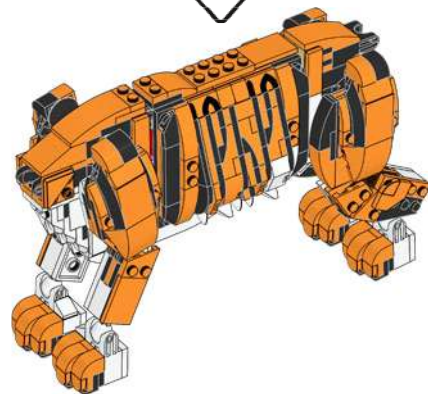
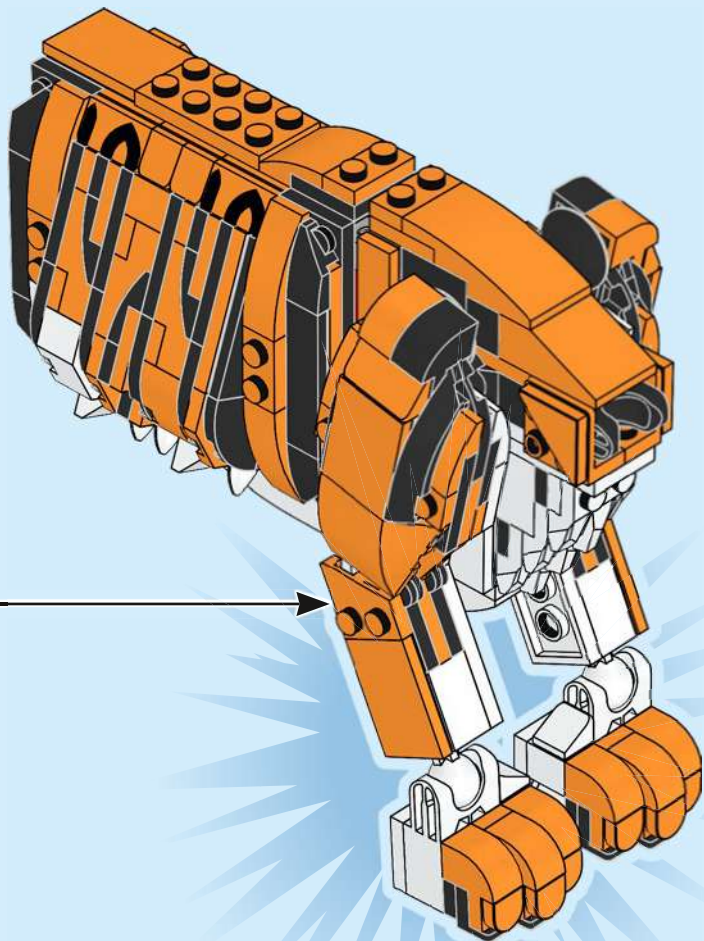



161

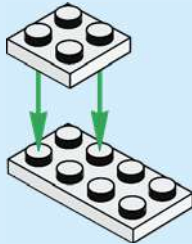

162

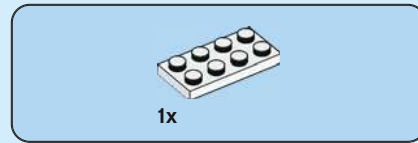

163

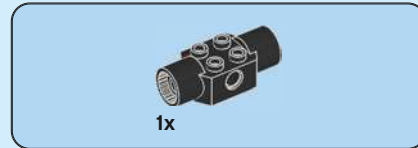

164





165

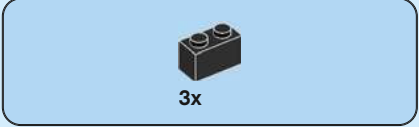
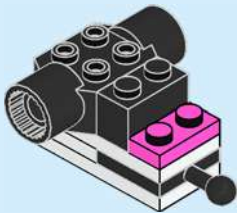

166

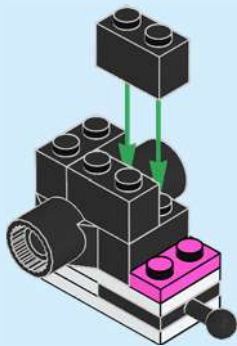

167

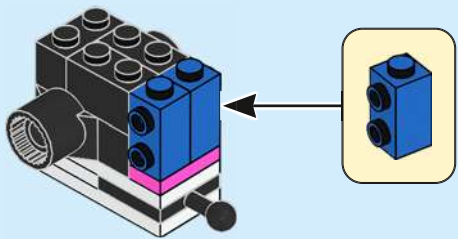

168

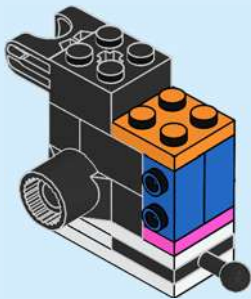



1x

169

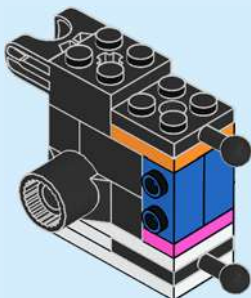

1x



1x

170

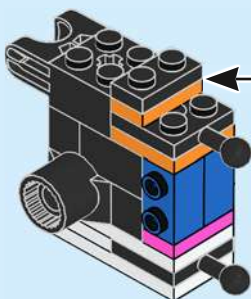

2x

171

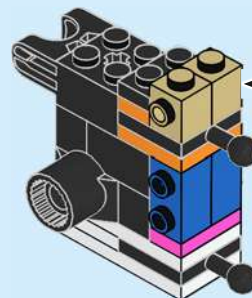

1x

172





1x



1x

# 173

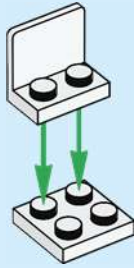

1x

# 174



2x

# 175



1x

# 176





177

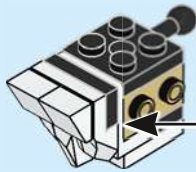
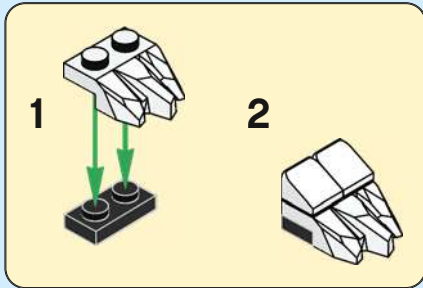

178

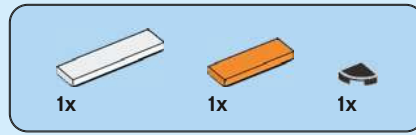
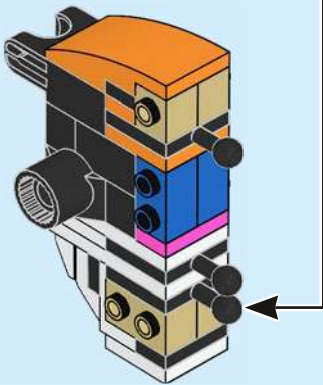

179

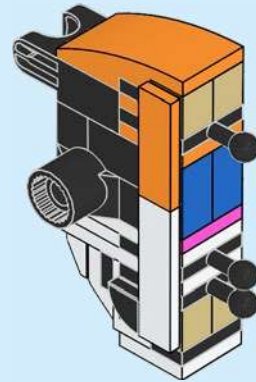

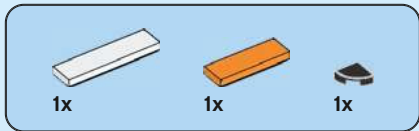

180

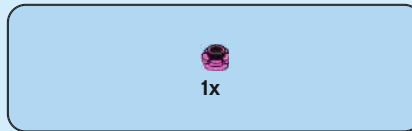

181

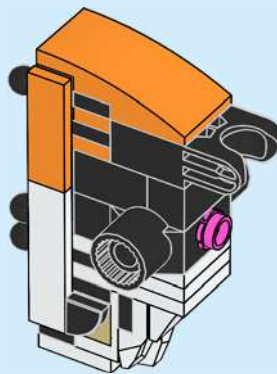



182

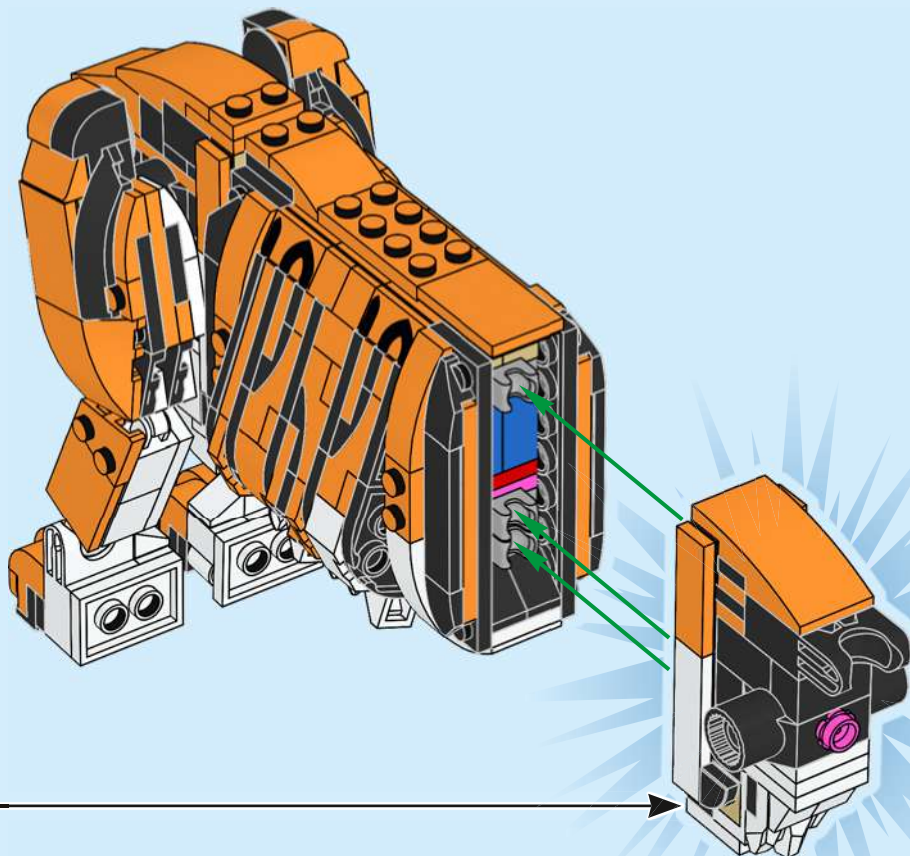

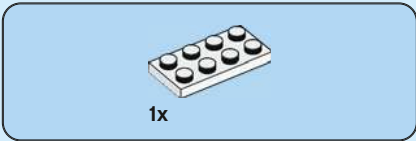
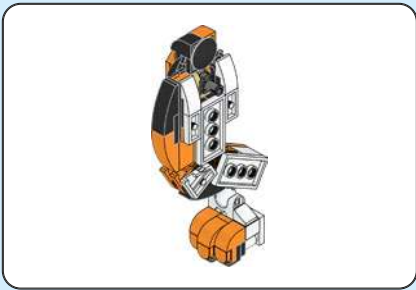

**183**



**184**

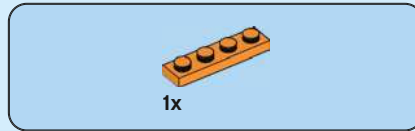

**185**



**186**

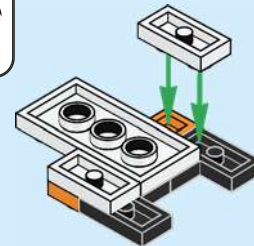

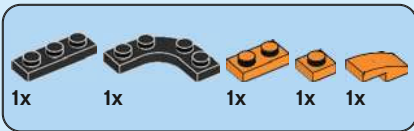

# 187

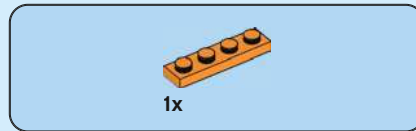
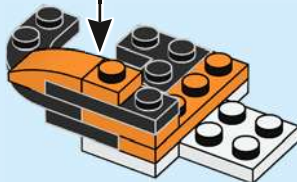
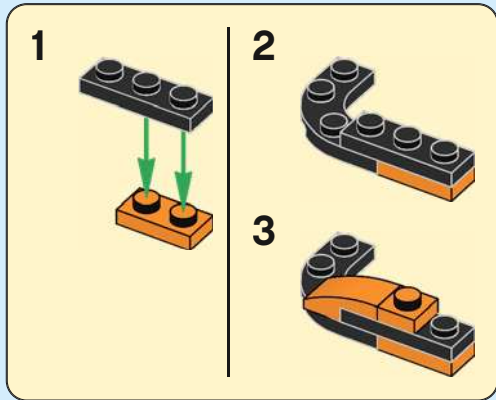

# 188

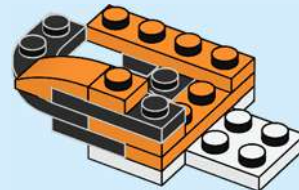

# 189

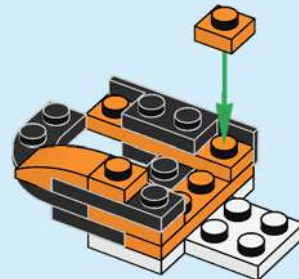



1x



1x

# 190

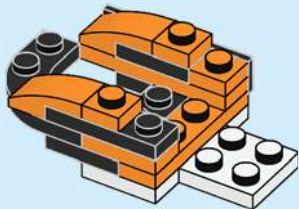

1x

# 191

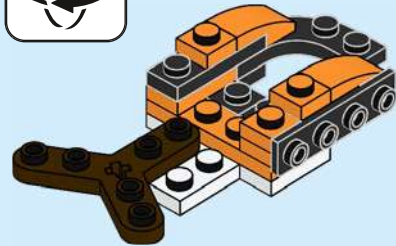

1x



1x

# 192

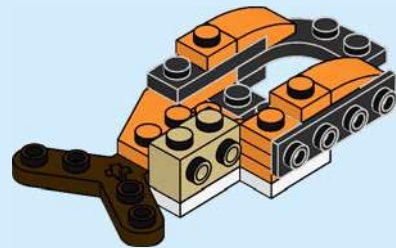



193

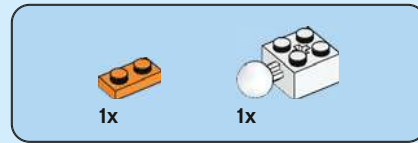

194



195





1x

# 196

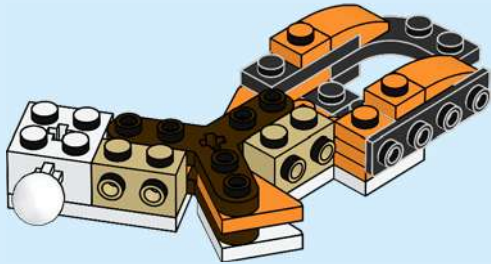

1x



1x

# 197

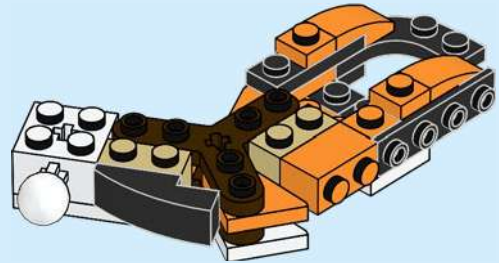

1x



2x



1x

# 198



1x



1x

# 199

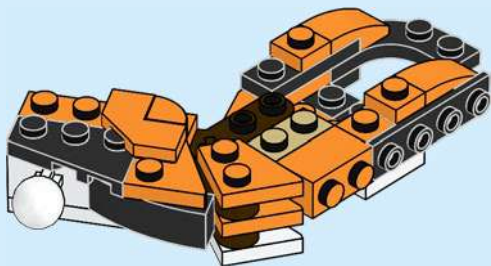

1x



1x

# 200

**CLICK KLICK  
CLIC CLIQUE  
KATT KLIKSKIS  
咔嗒**

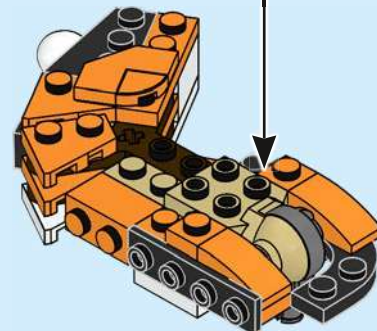
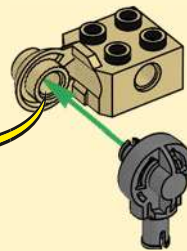



1x

# 201

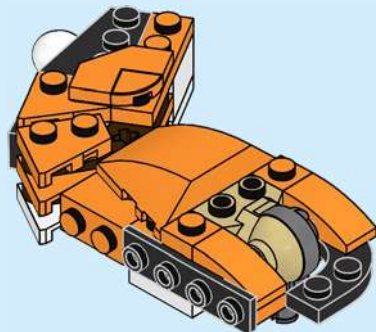

1x

# 202

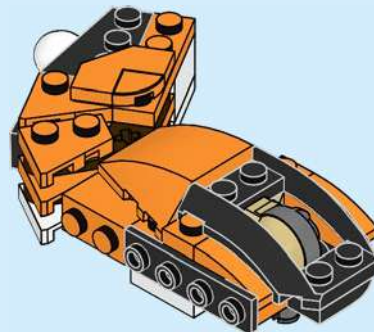

1x



1x

# 203

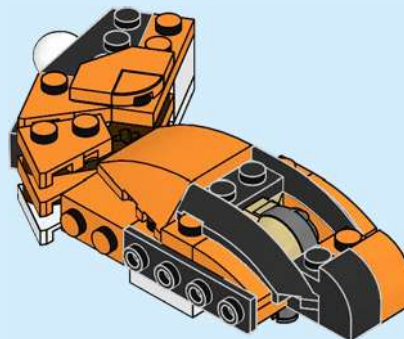



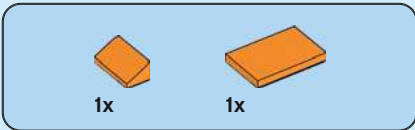

204

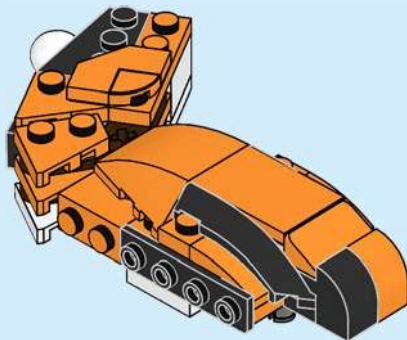

205

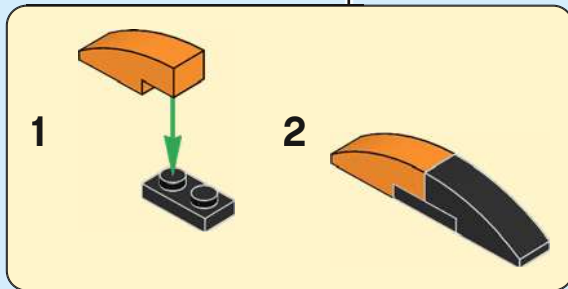
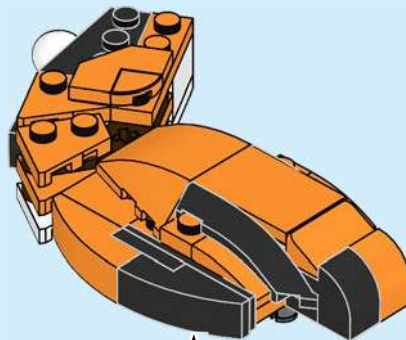



# 206

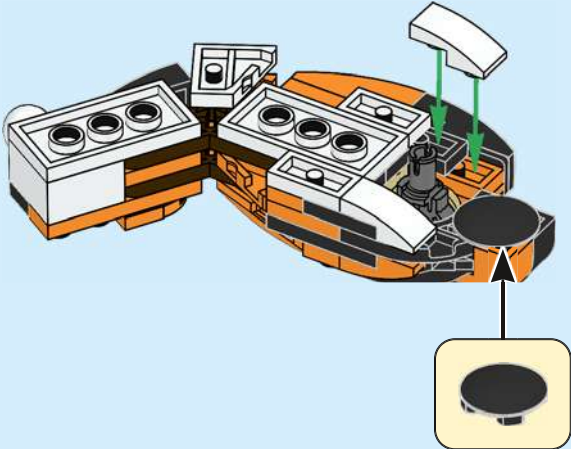



1x



1x

# 207

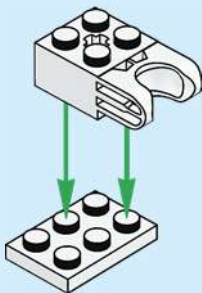

1x



1x

# 208

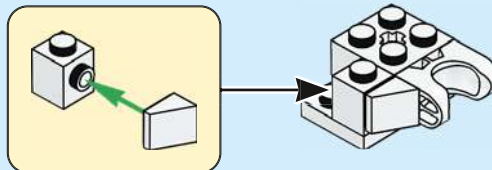

1x

# 209





210

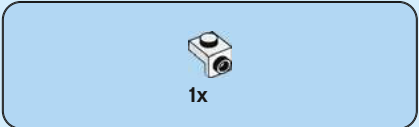

211

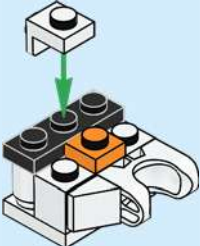

212

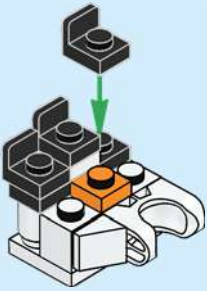

213

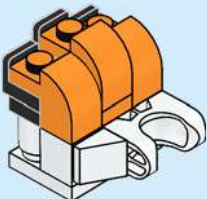

3x

214



215

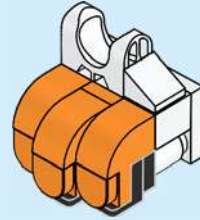

216

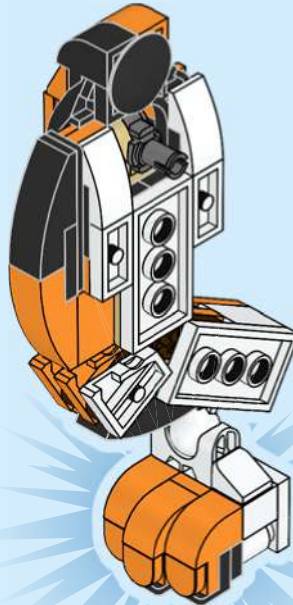

217

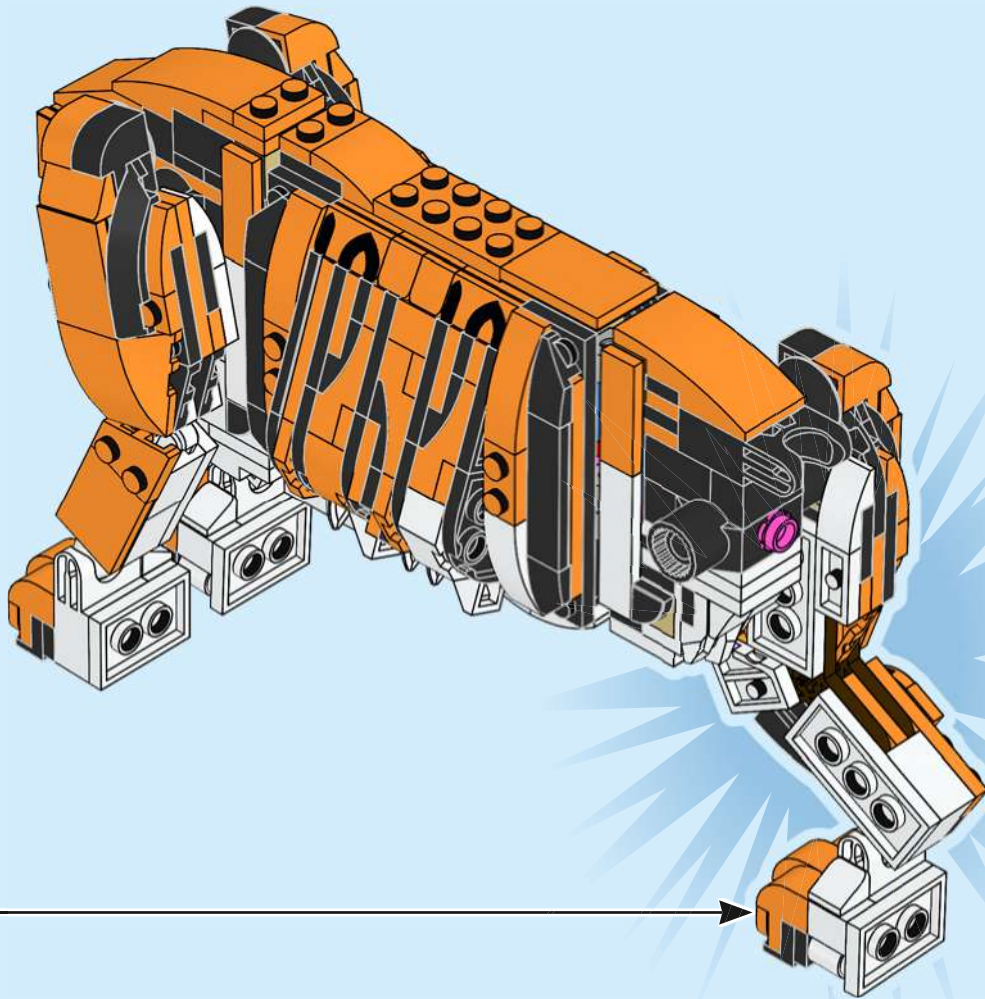

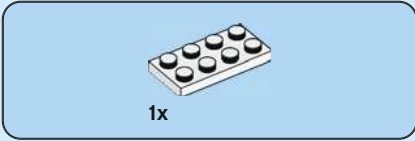
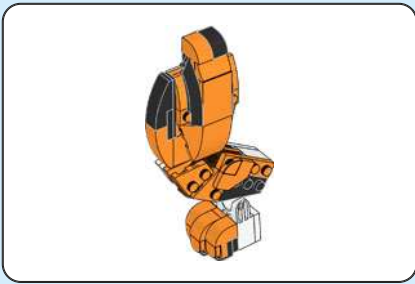

218



219

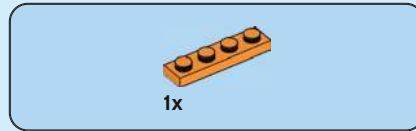
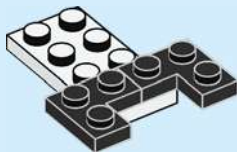

220



221

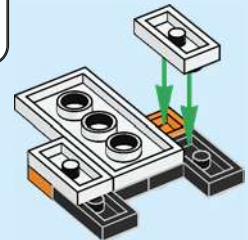

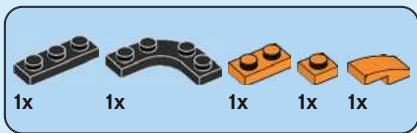

# 222

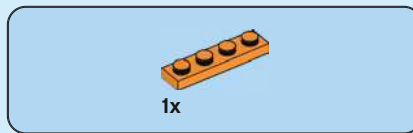
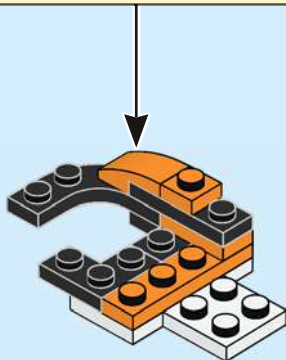
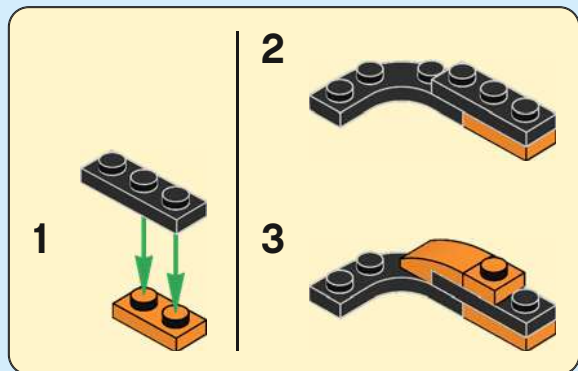

# 223

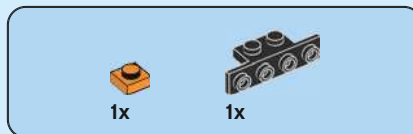
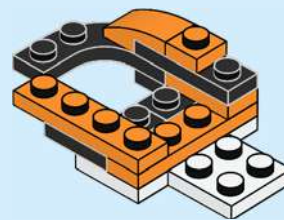

# 224

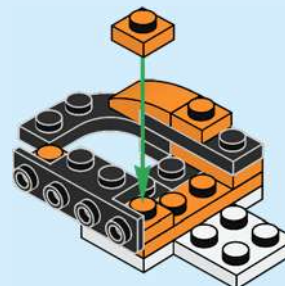





1x



1x

# 225

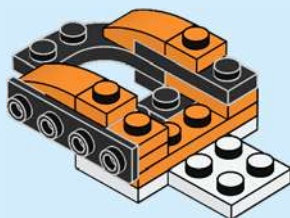

1x

# 226



1x



1x

# 227

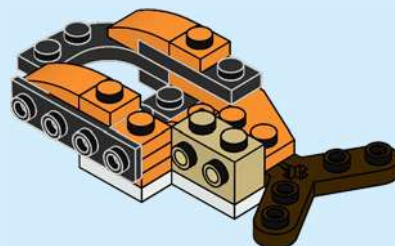

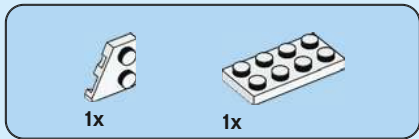

228

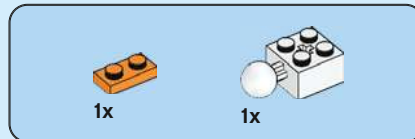

229

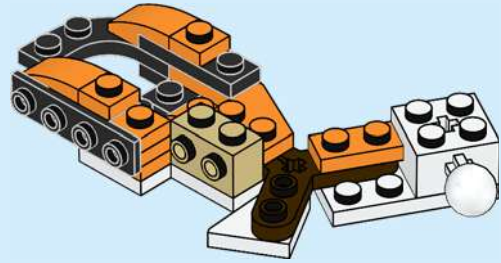

230

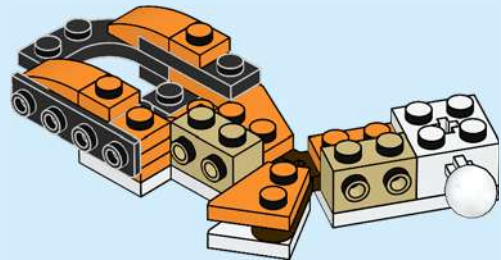



1x

# 231

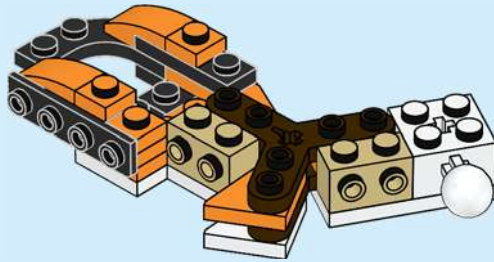

1x



1x

# 232

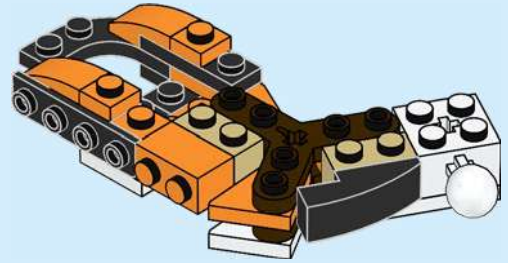

1x



2x



1x

# 233

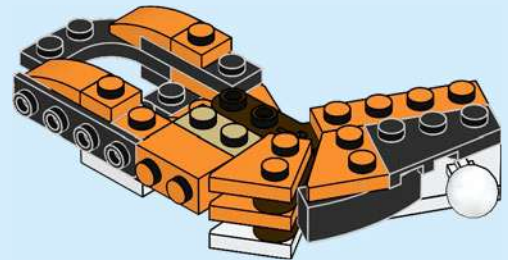



1x



1x

# 234

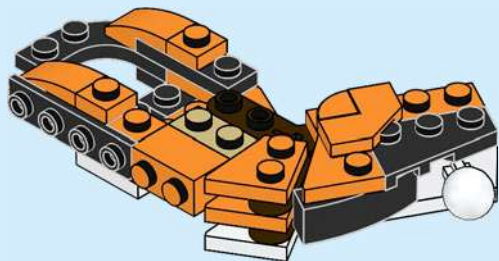

1x



1x

# 235

CLICK KLICK  
CLIC CLIQUE  
KATT KLIKŠKIS  
咔嗒

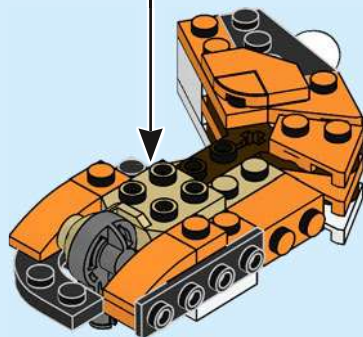
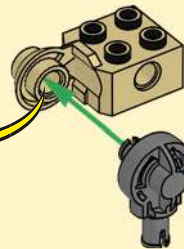



1x

# 236

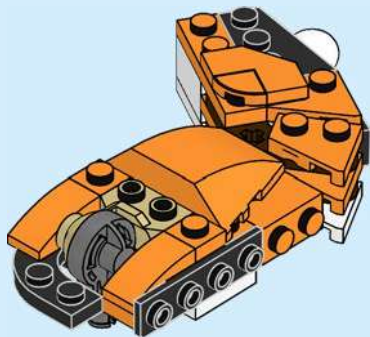

1x

# 237

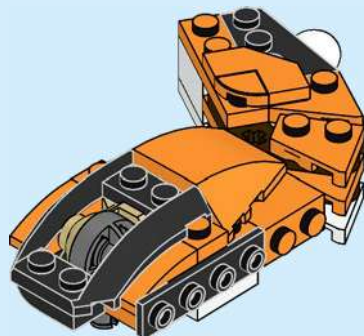

1x



1x

# 238

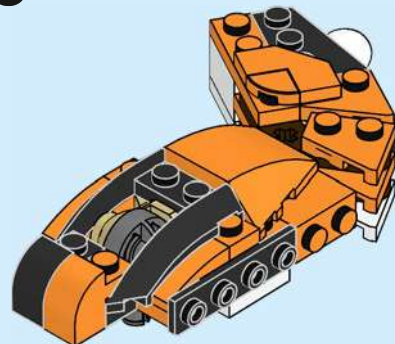

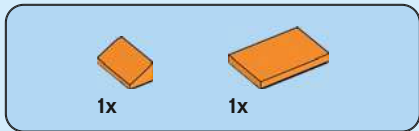

239

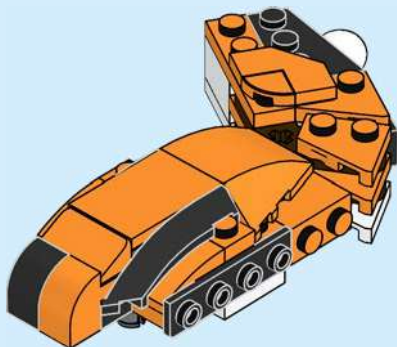

240

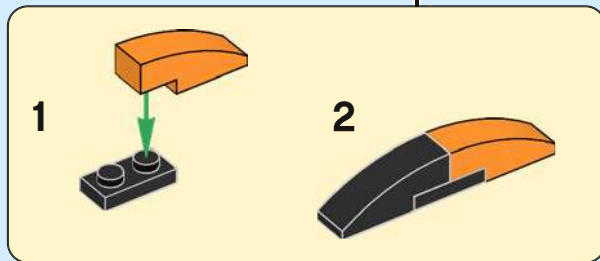
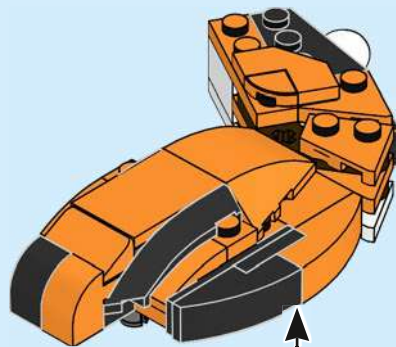



1x



2x

# 241

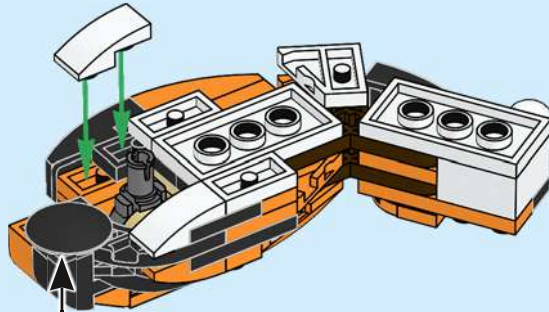



1x



1x

# 242

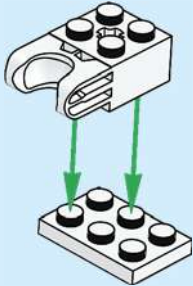

1x



1x

# 243

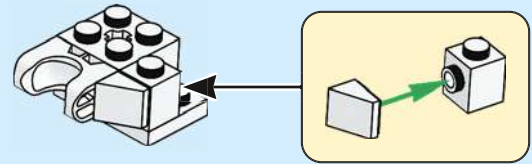

1x

# 244







1x



1x

# 245

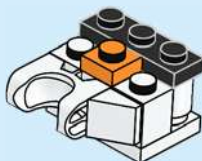

1x

# 246



3x

# 247

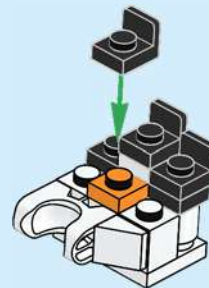

3x

# 248



3x

249



250

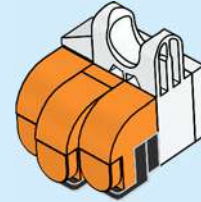

251

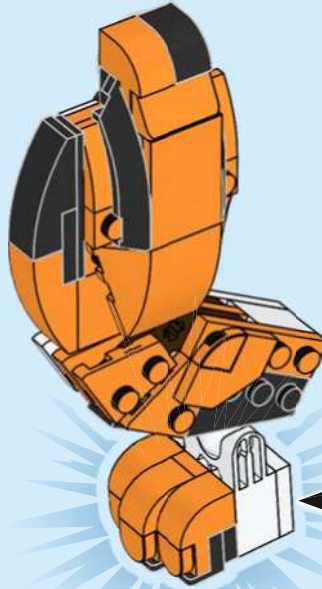

252

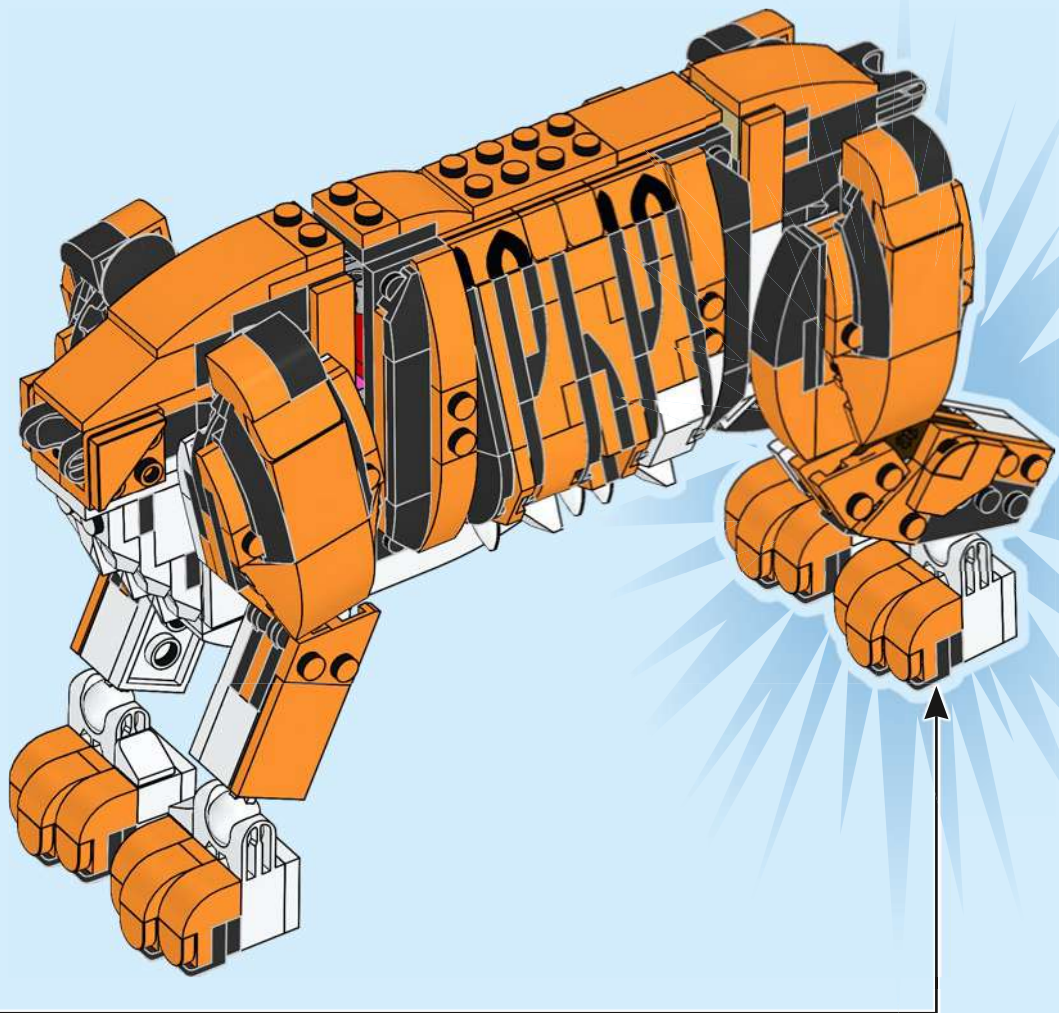

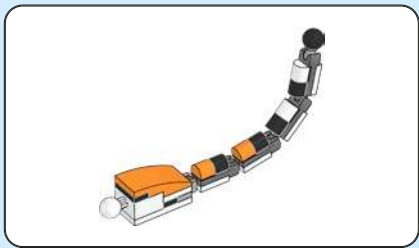
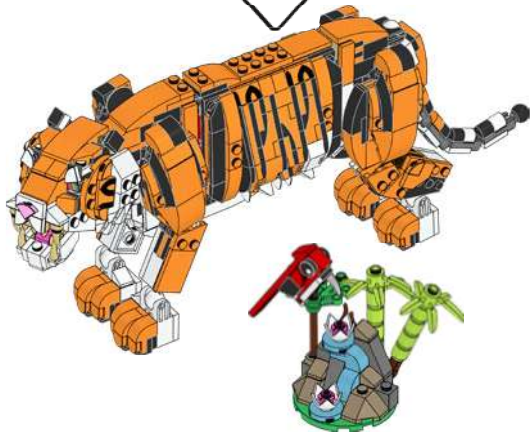

1x

**253**



1x



1x

**254**





1x

**255**

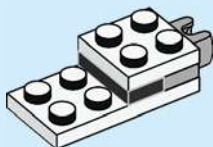

1x

**256**



1x

**257**



1x

**258**

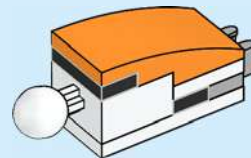



# 259

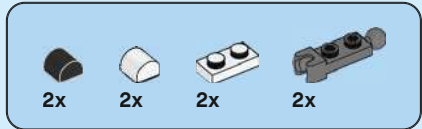
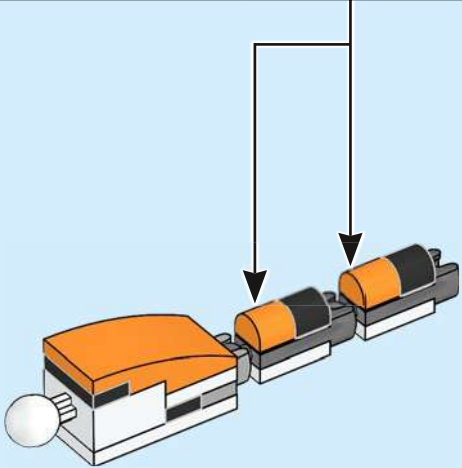
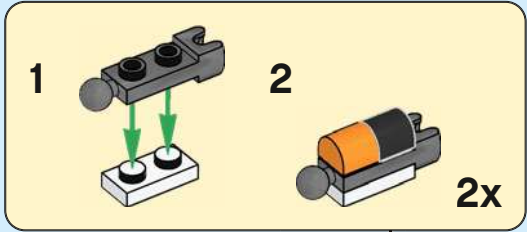

# 260

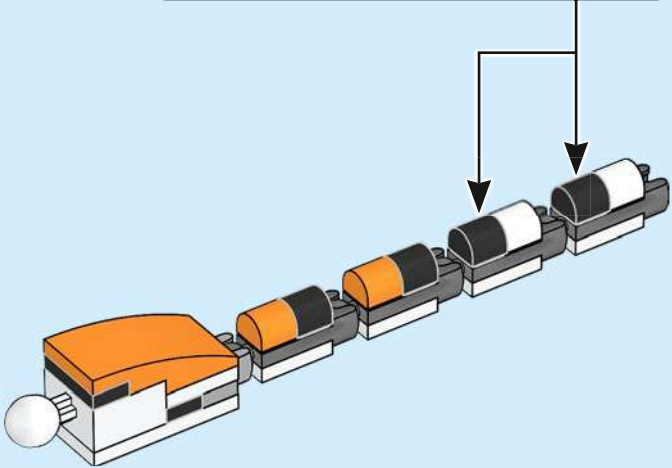
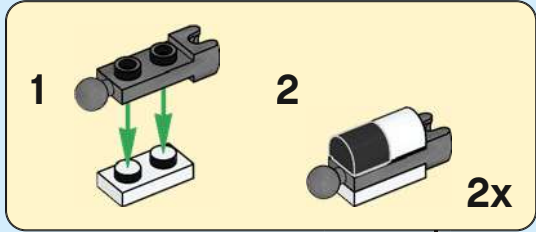



1x



1x

# 261

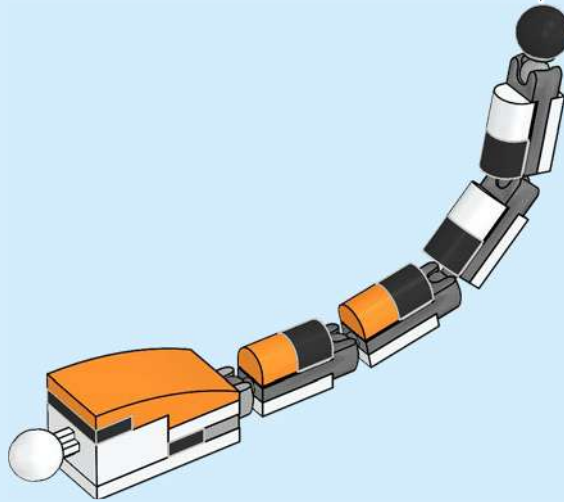
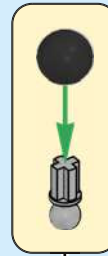

262

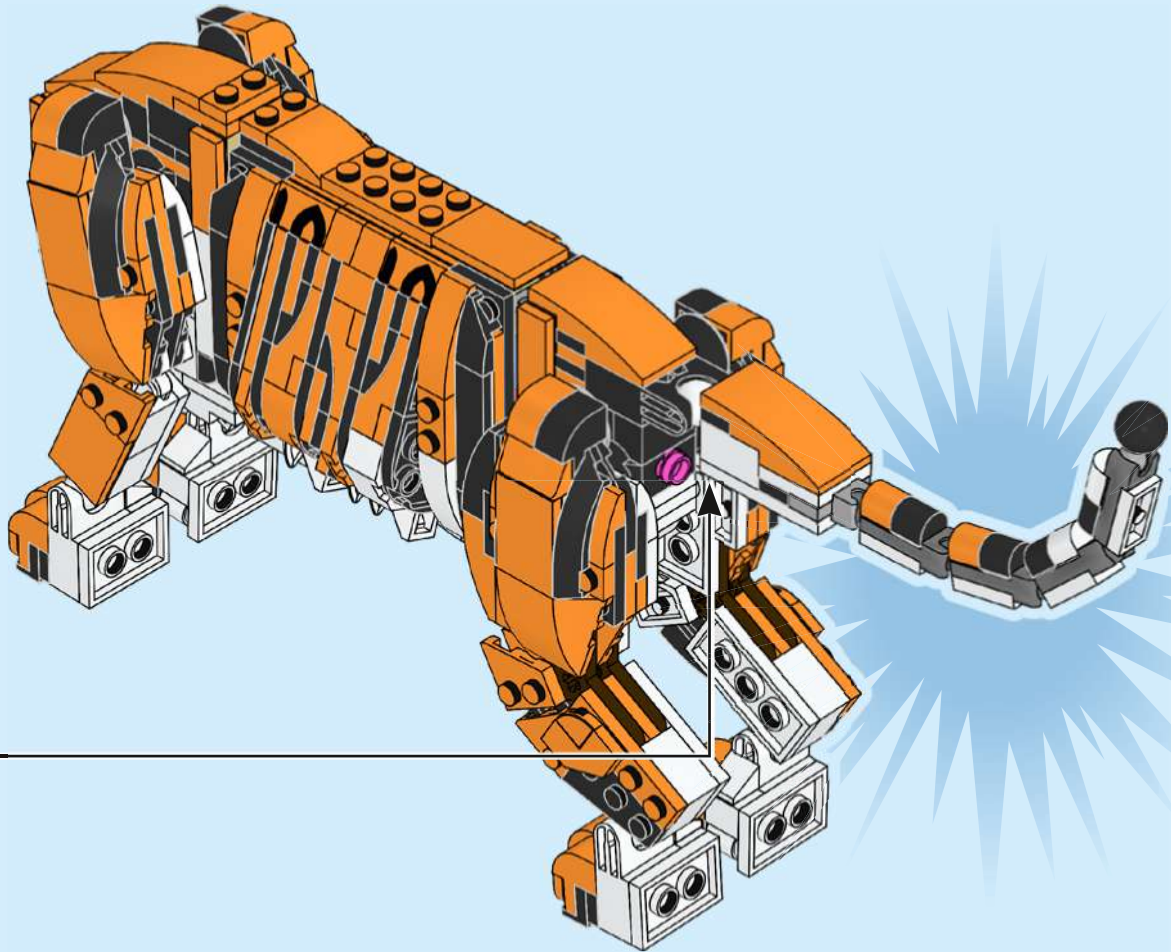



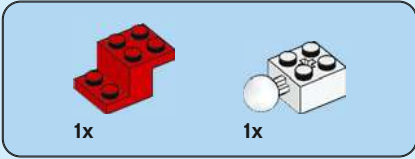
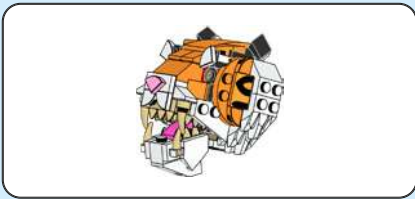

263

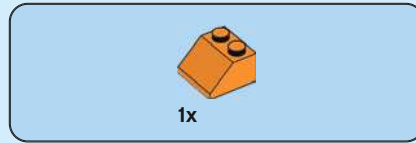
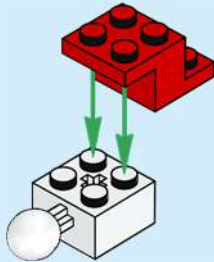

264

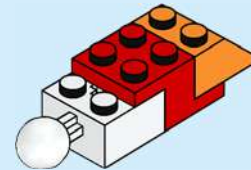

265

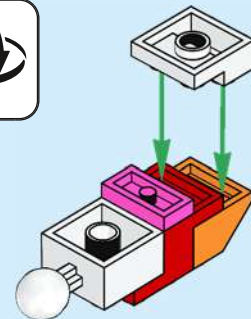



2x

# 266

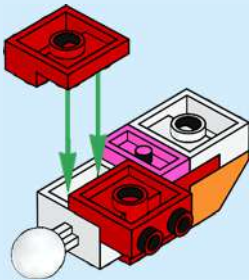

1x



2x



1x

# 267

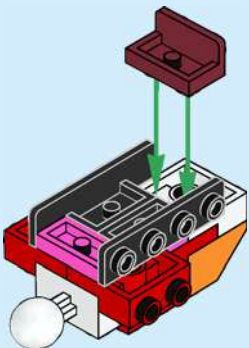

1x

# 268

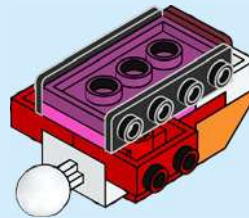

2x

# 269

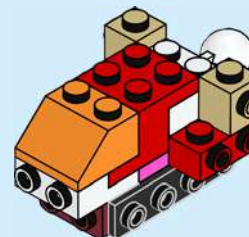

4x

2x

# 270

1



2



2x

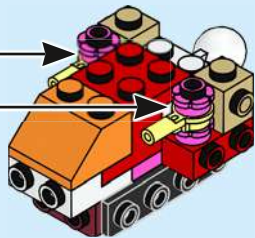

2x

2x

2x

2x

# 271

1



2



3



2x

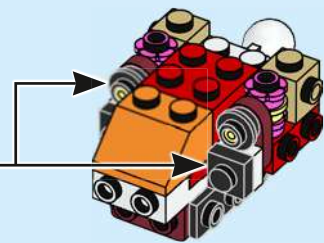

2x

# 272

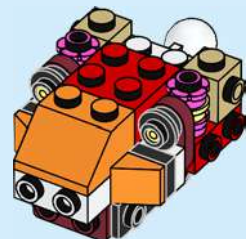



2x

# 273

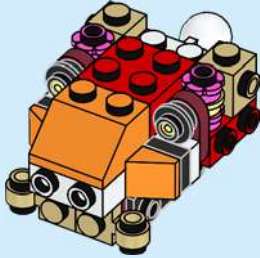

2x

# 274

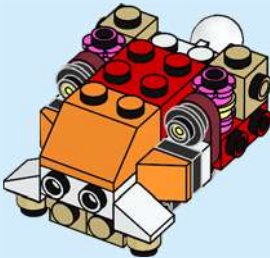

2x



3x

# 275

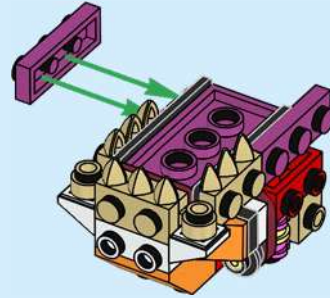

1x



2x



2x

# 276

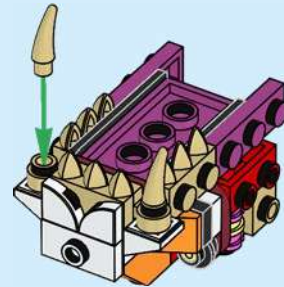

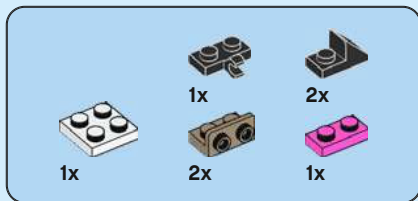

277

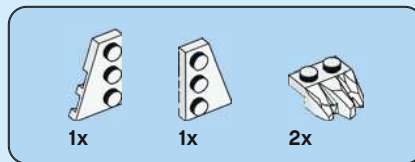
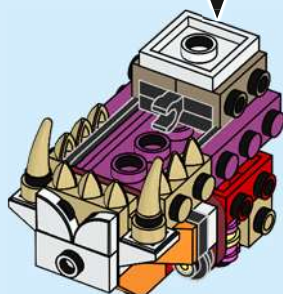
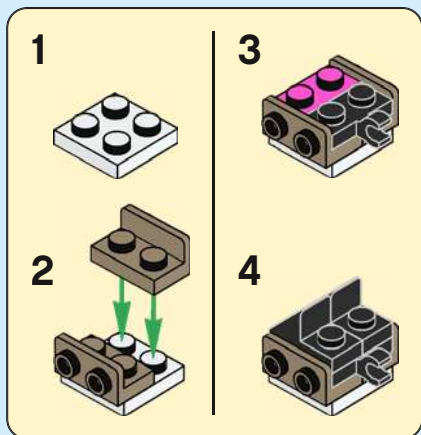

278

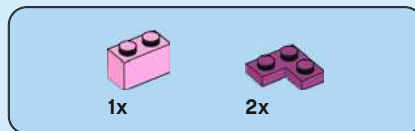
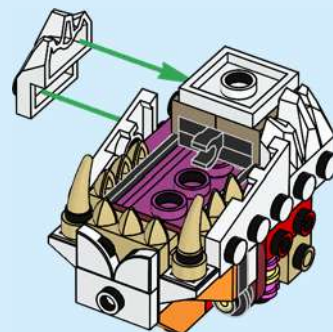

279

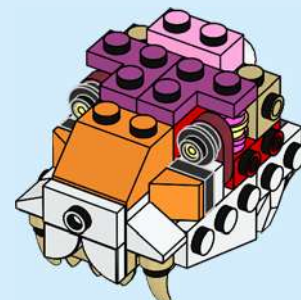



2x

# 280

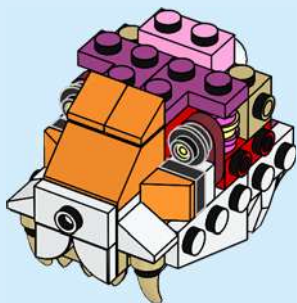

1x



2x

# 281

1



2

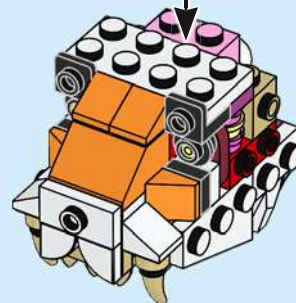



2x



1x

282

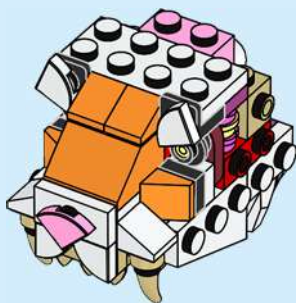

2x



2x

283

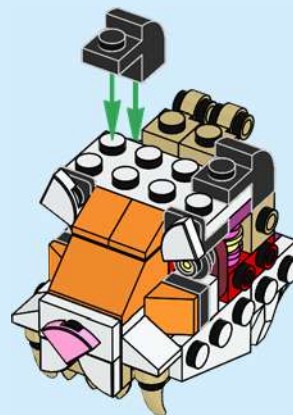



1x



1x

# 284

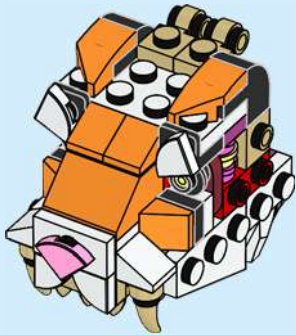

1x



2x

# 285

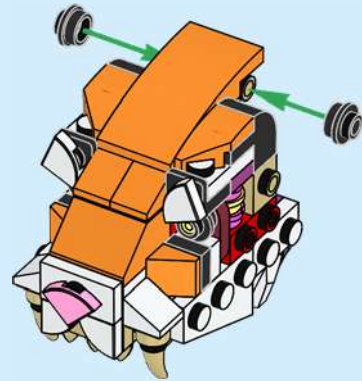





2x



2x



2x

# 286

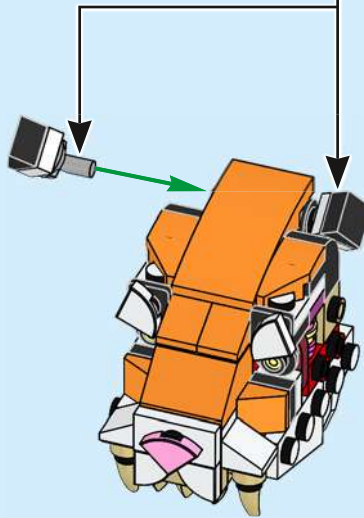
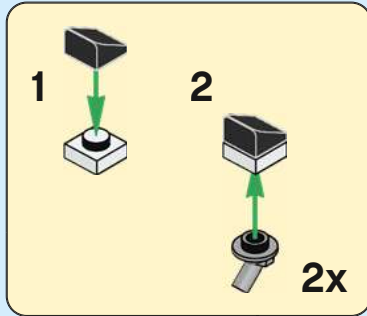

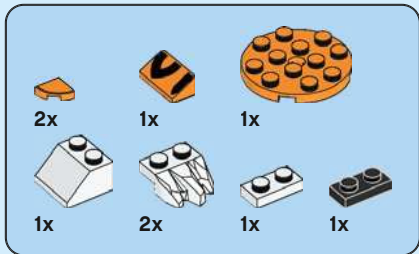

287

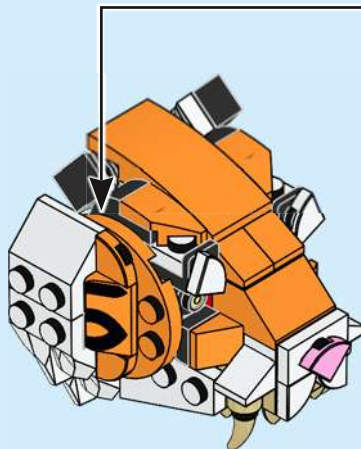
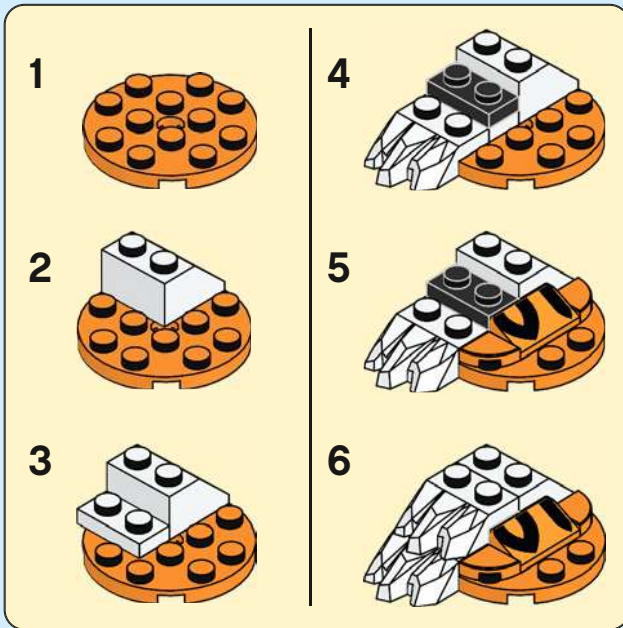

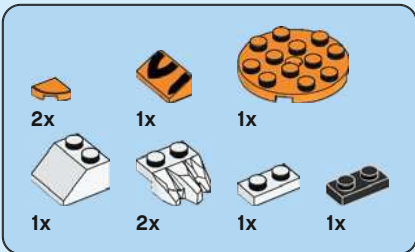

288

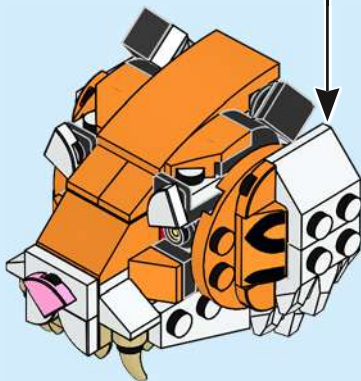
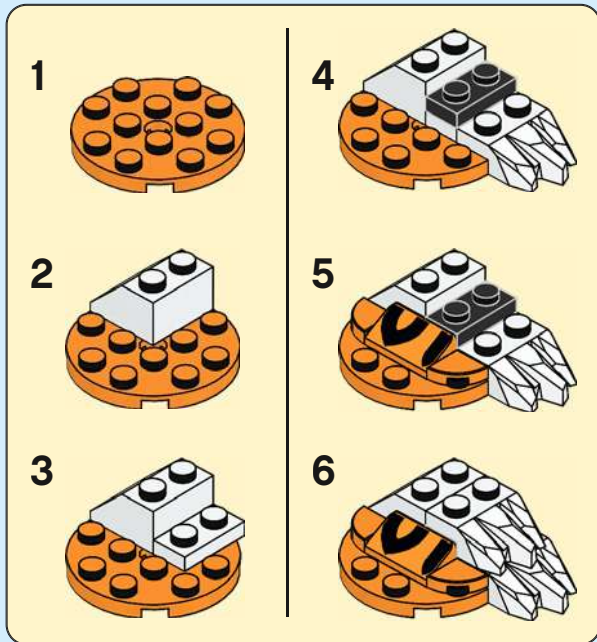

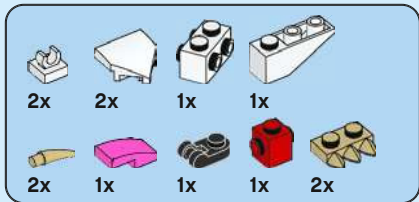

# 289

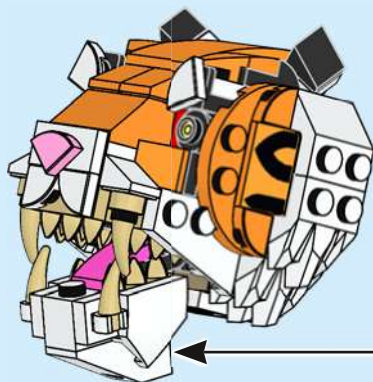
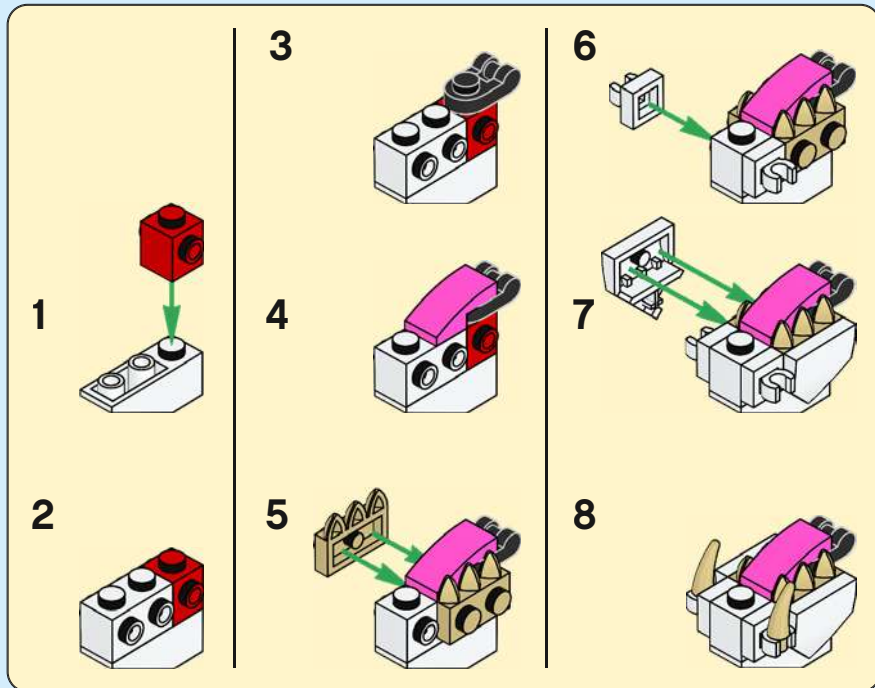

290

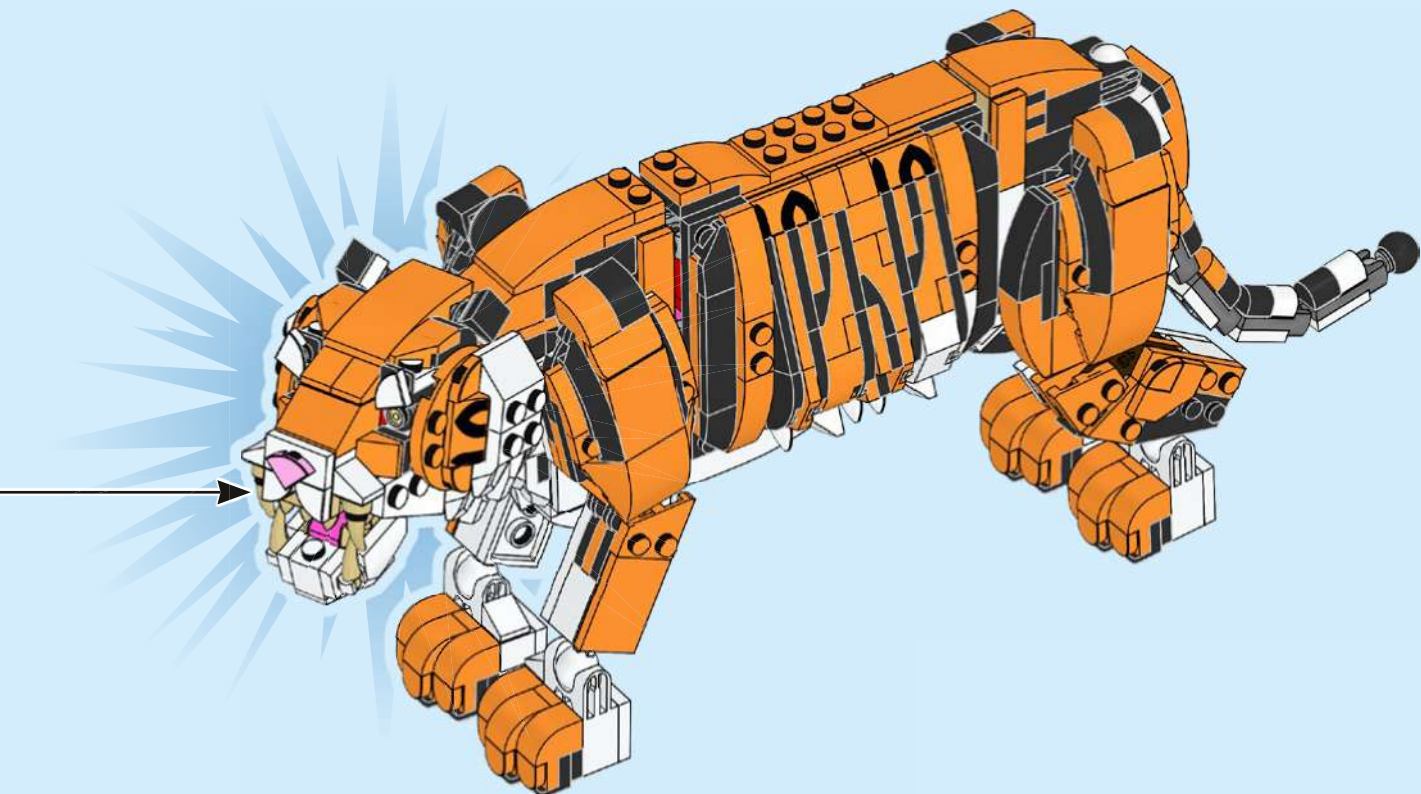

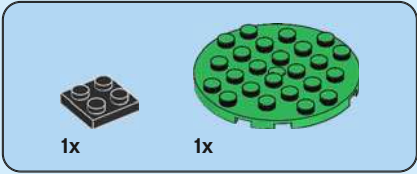

1

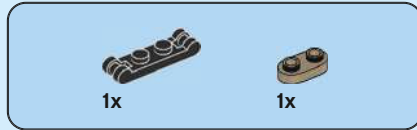
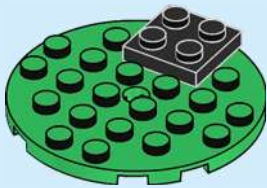

2

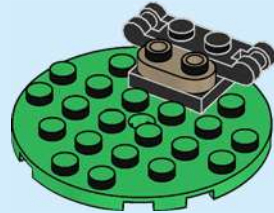

3

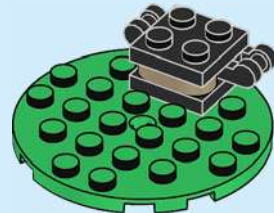



2x

4

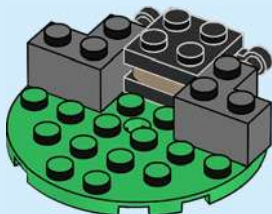

1x



1x

5

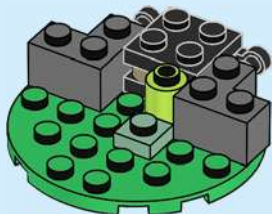

3x

6

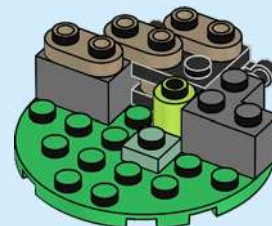

1x

7

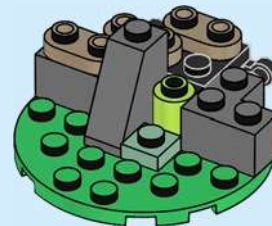



8

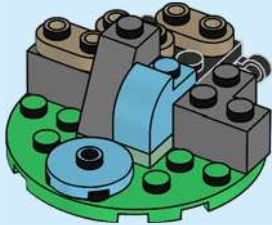

9

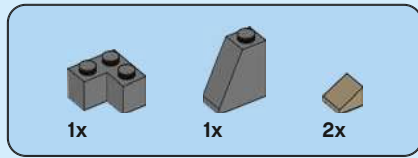
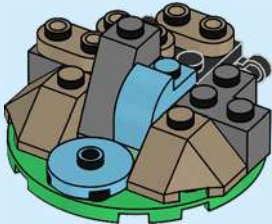

10

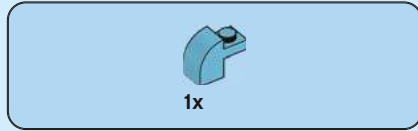
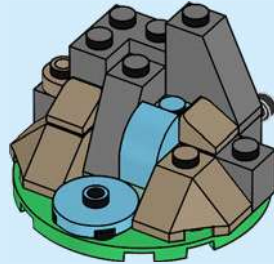

11

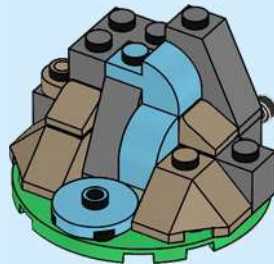





1x



1x

# 12

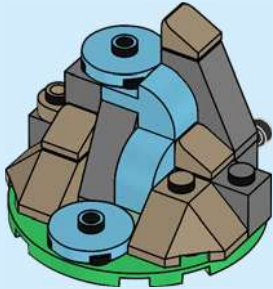

2x



2x

# 13

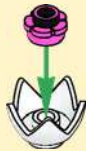
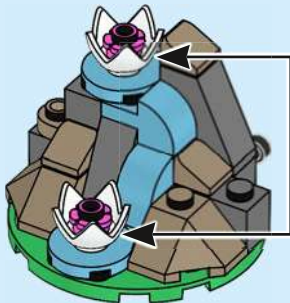

2x



2x



1x

# 14

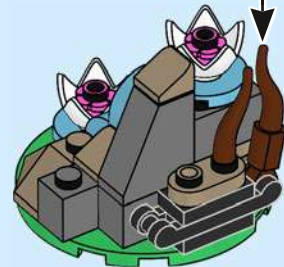

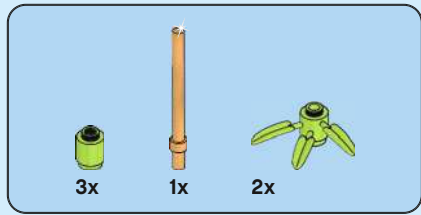

15

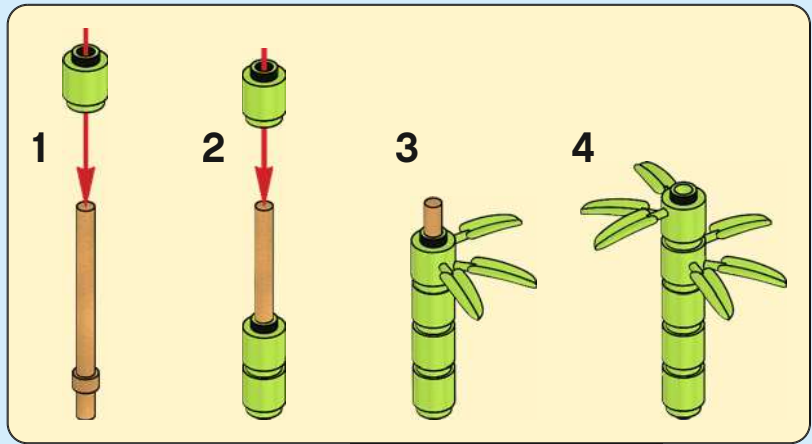

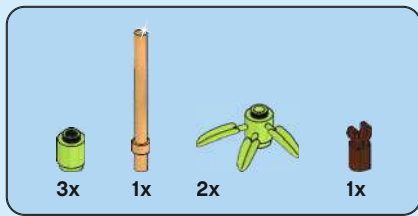

16

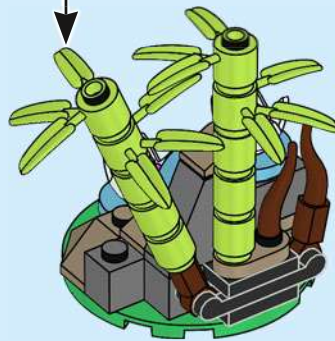
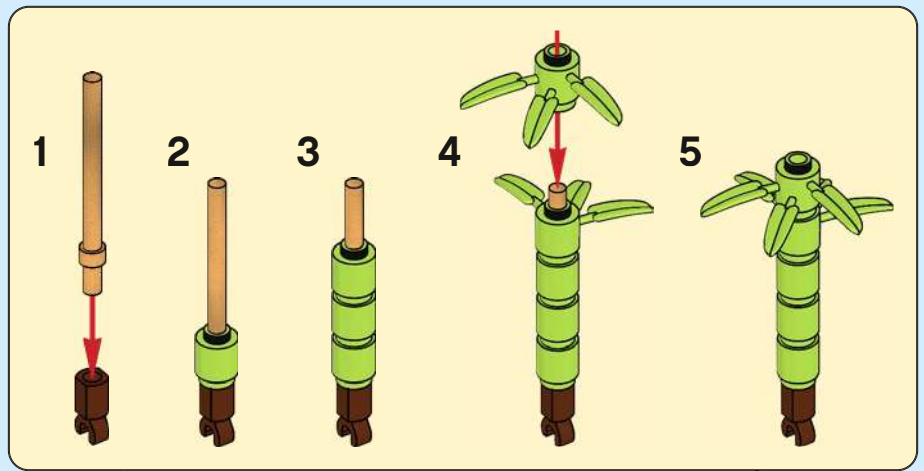



17

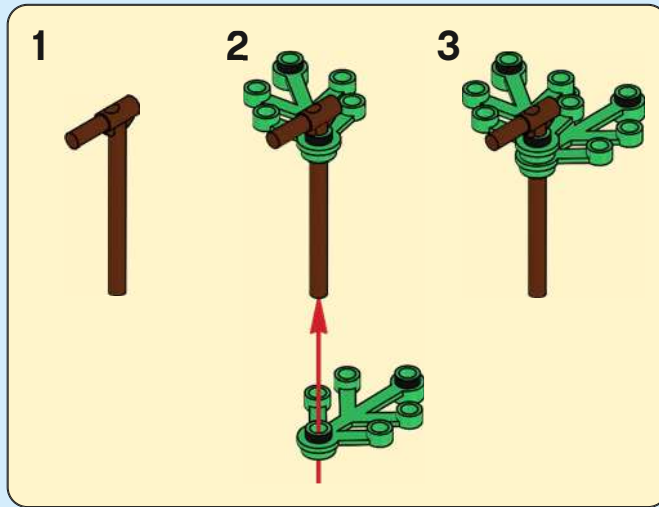



18

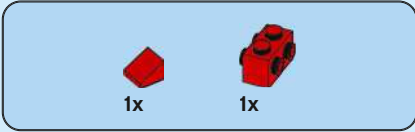
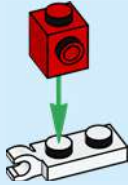

19

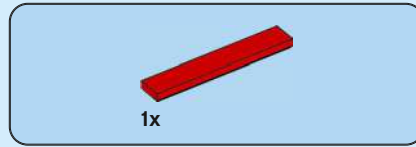
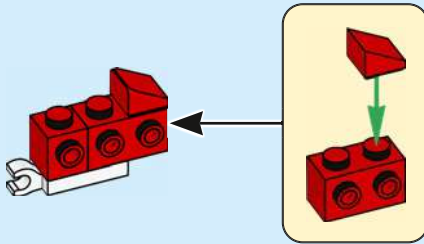

20

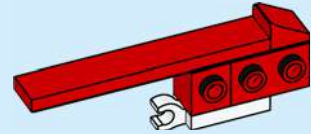

21

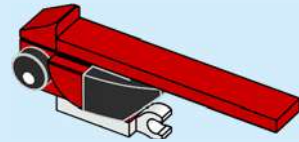



22

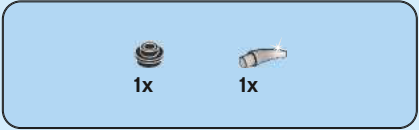
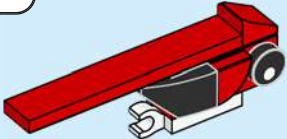

23

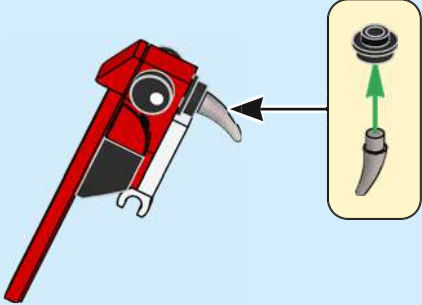

24







# CREATOR™

# 3 IN 1

**A tiger's stripes serve as camouflage in tall grass and bushes. The colours and spacing vary between subspecies and no two tigers have identical stripes.**

Die Streifen tarnen den Tiger im hohen Gras. Die Farben und der Abstand der Streifen unterscheiden sich von Unterart zu Unterart. Keine zwei Tiger besitzen dasselbe Streifenmuster.

Ses rayures permettent au tigre de se camoufler dans les hautes herbes et les buissons. Leur couleur et leur espacement varient d'une sous-espèce à une autre, et chaque tigre a des rayures uniques.

Le strisce consentono alla tigre di mimetizzarsi nell'erba alta e nei cespugli. I colori e la distanza variano tra le sottospecie e non esistono due tigri con strisce identiche.

Las rayas del tigre le sirven para camuflarse entre la hierba alta y los arbustos. Su color y separación varían según la subespecie y no hay dos tigres con rayas idénticas.

As riscas do tigre servem de camuflagem no capim e arbustos. As cores e o espaçamento variam entre subespécies e não há dois tigres com riscas idênticas.

A tigris csíkjai álcaként szolgálnak, elrejtik őt a magas fűben és a bozótban. A színek és a távolság alfajonként változik, és nincs két tigris egyforma csíkokkal.

Tīģera svītras palīdz maskēties garā zālē un krūmos. Svītru krāsa un izvietojums dažādām pasugām atšķiras, un nav divu tīģeru ar vienādām svītrām.

老虎身上的条纹在茂密的草丛和灌木丛中可以起到伪装作用。老虎身上条纹的颜色和间距因其种类的不同而异，没有任何两只老虎拥有相同的条纹。

**Despite their bright fur, tigers can easily sneak up on their prey. Deer and most other prey animals are colour blind and just see the orange fur as green vegetation.**

Trotz ihres leuchtenden Fells können Tiger ihrer Beute leicht auflauern. Die meisten Beutetiere sind farbenblind und können das orange Fell nicht von grünen Pflanzen unterscheiden.

Malgré la couleur de sa fourrure, le tigre peut facilement passer inaperçu. Les cerfs et la plupart de ses autres proies étant daltoniens, ils confondent sa fourrure orange avec la végétation verte.

Nonostante il loro manto appariscente, le tigri riescono facilmente a sorprendere le loro prede. I cervi e la maggior parte degli animali da preda sono daltonici e il manto arancione della tigre appare loro come vegetazione di colore verde.

A pesar de su llamativo pelaje, los tigres saben acercarse sigilosamente a sus presas. Los ciervos y la mayoría de los animales de presa son daltónicos y el pelo naranja les parece vegetación verde.

Apesar do pelo brilhante, os tigres podem aproximar-se furtivamente das suas presas. Os veados e a maioria dos outros predadores são daltónicos e veem o pelo laranja como se fosse vegetação verde.



Élénk színű bundájuk ellenére a tigrisek könnyen a zsákmányuk közelébe lopózkodhatnak. A szarvasok és a zsákmányállatok többsége színvak, és a narancssárga tigriszőrt zöld növényzetnek látják.

Kaut arī tīģeriem ir košs kažoks, tie var viegli pielavīties medījumam. Briēži un daudzi citi medijamie dzīvnieki neatšķir krāsas, tāpēc tie oranžo kažoku redz tāpat kā zaļos augus.

尽管老虎的皮毛非常鲜亮，但它们却很容易偷袭到猎物。这是因为鹿和大多数其他猎物都是色盲，会把金黄色皮毛看作绿色的植被。







## A tiger doesn't roar often, but when it does, it can be heard up to 3 kilometres away!

Ein Tiger brüllt nicht oft, ist aber dafür noch in 3 km Entfernung zu hören!

Le tigre ne rugit pas souvent, mais lorsqu'il le fait, on l'entend à 3 km à la ronde !

Una tigre non ruggisce spesso, ma quando lo fa può essere udita fino a 3 chilometri di distanza!

Los tigres no rugen a menudo, pero, cuando lo hacen, ¡se les puede oír hasta a 3 km de distancia!

Um tigre não ruge com frequência, mas quando o faz, pode ser ouvido a 3 km de distância!

A tigris nem üvölt gyakran, de ha igen, akkor akár 3 km-re is elhallatszík!

Tígeris rēc reti, bet tā rēcienu var dzirdēt pat 3 km attālumā!

老虎不经常吼叫, 但当它吼叫时, 声音会传到 1.9 英里之外!

## 2022 is the Year of the Tiger in the Chinese Zodiac calendar.

2022 ist das Jahr des Tigers im chinesischen Kalender.

2022 est l'année du Tigre dans l'astrologie chinoise.

Il 2022 è l'Anno della Tigre nello zodiaco cinese.

2022 es el Año del Tigre en el Zodiaco chino.

2022 é o Ano do Tigre no Zodiaco chinês.

2022 a tigris éve a kínai horoszkóp szerint.

Pēc ķīniešu zodiaka kalendāra 2022. gads ir tīģera gads.

2022 年是中国虎年。





8x  
4504369

4x  
243101

4x  
306201

6x  
4224792

4x  
6230579

2x  
6013658

7x  
4212454

2x  
303421

4x  
6172366

1x  
6132204

2x  
6258135

2x  
6330191

2x  
4518892

3x  
4211109

4x  
6175572

2x  
614321

2x  
6301907

1x  
300301

1x  
6361170

1x  
428701

1x  
6210310

4x  
6338166

2x  
6315482

2x  
6030266

1x  
6051511

2x  
6198933

4x  
6296132

2x  
6034675

2x  
6212040

4x  
4522784

4x  
6290531

1x  
4113858

15x  
302301

2x  
6198933

4x  
4558952

1x  
4667575

1x  
6264026

4x  
6338168

14x  
4579260

6x  
6187620

8x  
6172927

14x  
302001

2x  
6348055

2x  
4160403

17x  
6209679

11x  
6338165

6x  
6024495

1x  
4569056

4x  
6218823

4x  
302101

1x  
6046979

4x  
4121932

11x  
6057387

2x  
6326748

5x  
6046907

1x  
4504379

1x  
6097637

2x  
6156667

2x  
6210385

2x  
4249112

3x  
6132918

1x  
4211375

4x  
6063671

2x  
6170390

10x  
6181319

2x  
6259700

1x  
6132203

2x  
6137926

1x  
6289701

2x  
6341968

6x  
4218749

2x  
6061711

6x  
302201

4x  
302401

1x  
4179875

1x  
6240463

2x  
6296963

1x  
6214343

4x  
6281995

1x  
6172642

6x  
6307640

1x  
6053026

1x  
4179874

4x  
6096589

2x  
6170470

2x  
6269077

12x  
4516055

1x  
6313116

4x  
6360826

2x  
303901

1x  
383201

1x  
4517993

4x  
6328094

4x  
6375375

2x  
6296186



4x  
4525236



4x  
6325190



2x  
4504382



6x  
6359224



2x  
6191630



2x  
6360825



6x  
6184784



1x  
4290713



4x  
4278359



4x  
6273589



5x  
6181720



5x  
6181713



22x  
362326



4x  
4251161



14x  
6234695



4x  
6172383



8x  
4227392



5x  
6168646



8x  
302426



4x  
6168620



1x  
6157554



6x  
6069000



12x  
302326



6x  
6147050



2x  
6141556



4x  
303426



1x  
6099483



4x  
6102782



2x  
6141554



4x  
302226



10x  
300426



6x  
243126



2x  
6284072



8x  
242026



1x  
4180536



1x  
4180508



12x  
4118782



1x  
4118828



1x  
6067913



2x  
6061676



1x  
4121742



1x  
4158355



8x  
6055069



6x  
6173925



6x  
6173928



6x  
6173933



2x  
6346092



1x  
6177490



1x  
6177499



4x  
6054529



4x  
6329309



2x  
4159007



2x  
6184997



6x  
4173332



2x  
4173805



6x  
6366029



6x  
4121739



4x  
4620693



17x  
4177932



7x  
6293710



26x  
4524929



2x  
6289374



4x  
6218367



2x  
6226926



8x  
4504371



12x  
6344851



2x  
6278436



6x  
6366029



6x  
4121739



4x  
6068996



2x  
6022048



16x  
6112356



8x  
4251969



6x  
6375376



2x  
6331865



4x  
6231386



3x  
6040126



2x  
6250168



1x  
6037658



1x  
6097413



2x  
6268814



4x  
6179916



2x  
6335566



2x  
6136419



1x  
6099189



1x  
6270108

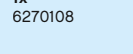

1x  
6097413



2x  
6268814



1x  
6254100



Customer Service

Kundenservice

Service Consommateurs

Servicio Al Consumidor

LEGO.com/service or dial



: 00800 5346 5555

: 1-800-422-5346

# WIN

GO TO [WWW.LEGO.COM/PRODUCTFEEDBACK](http://www.LEGO.COM/PRODUCTFEEDBACK) AND  
GIVE US YOUR SHORT **FEEDBACK** ABOUT THIS  
LEGO® SET FOR A CHANCE TO WIN  
A COOL LEGO PRIZE.

Terms & Conditions apply

## [LEGO.com/productfeedback](http://LEGO.com/productfeedback)



### GEWINNE

Erzähle uns auf  
[www.LEGO.com/productfeedback](http://www.LEGO.com/productfeedback)

etwas über die Erfahrungen, die du mit  
diesem LEGO® Set gemacht hast, und  
sichere dir die Chance auf einen coolen  
LEGO Preis!

Es gelten die Teilnahmebedingungen

### GAGNE

Rends-toi sur  
[www.LEGO.com/productfeedback](http://www.LEGO.com/productfeedback)

et donne-nous quelques commentaires  
sur ce produit LEGO® pour avoir une  
chance de gagner un prix LEGO !

Voir Conditions Générales

### GANA

Visita  
[www.LEGO.com/productfeedback](http://www.LEGO.com/productfeedback)

y envíanos tu opinión acerca de este  
set LEGO®. ¡Participarás en el sorteo de  
un premio LEGO!

Términos y Condiciones aplicables

### 获取奖品

登录  
[www.LEGO.com/productfeedback](http://www.LEGO.com/productfeedback)

给出关于此乐高®套装的简短反馈，  
就有机会获得炫酷乐高奖品

《条款及条件》适用

LEGO and the LEGO logo are trademarks of the LEGO Group. ©2022 The LEGO Group.