

A

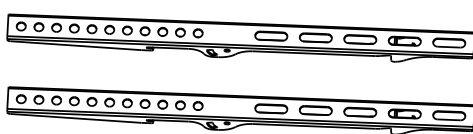

B

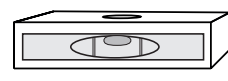

C

- Package M**
- M5x14 (x4) M-A
 - M6x14 (x4) M-B
 - M6x30 (x4) M-C
 - M8x30 (x4) M-D
 - M8x50 (x4) M-E
 - M8x12 (x4) M-J
 - D5 washer (x4) M-F
 - D8 washer (x4) M-G
 - small spacer (x8) M-H
 - big spacer (x8) M-I
- Package W**
- ST6.3x55 (x5) W-A
 - D6 washer (x5) W-C
 - concrete anchor (x5) W-B
-



WM4631 Universal Electrotech BV - Europe & International
P.O. Box 3332, 7500 DH Enschede
The Netherlands
716026
RDN-T150323

START

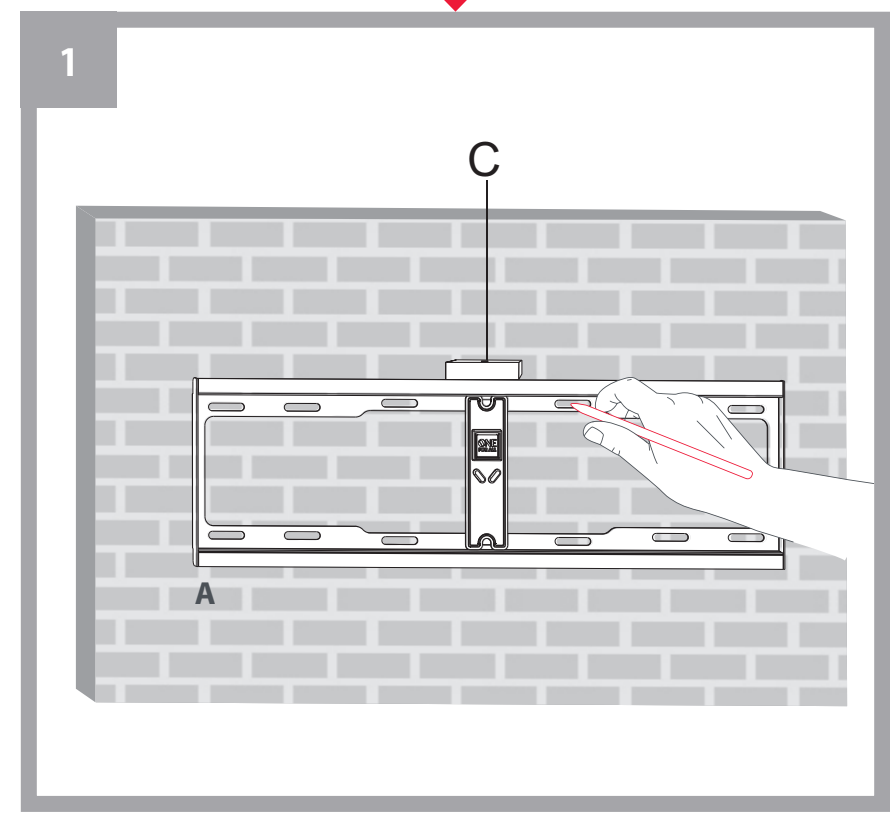

2 **WARNING**

Please verify that the supporting surface will safely support the combined weight of the equipment and all attached hardware and components.

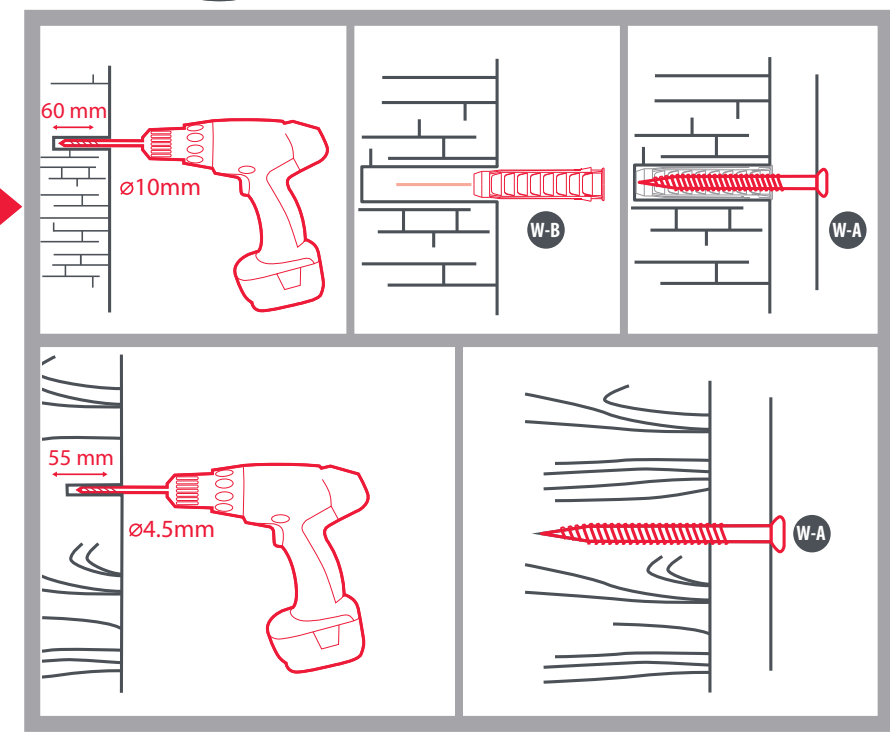

3

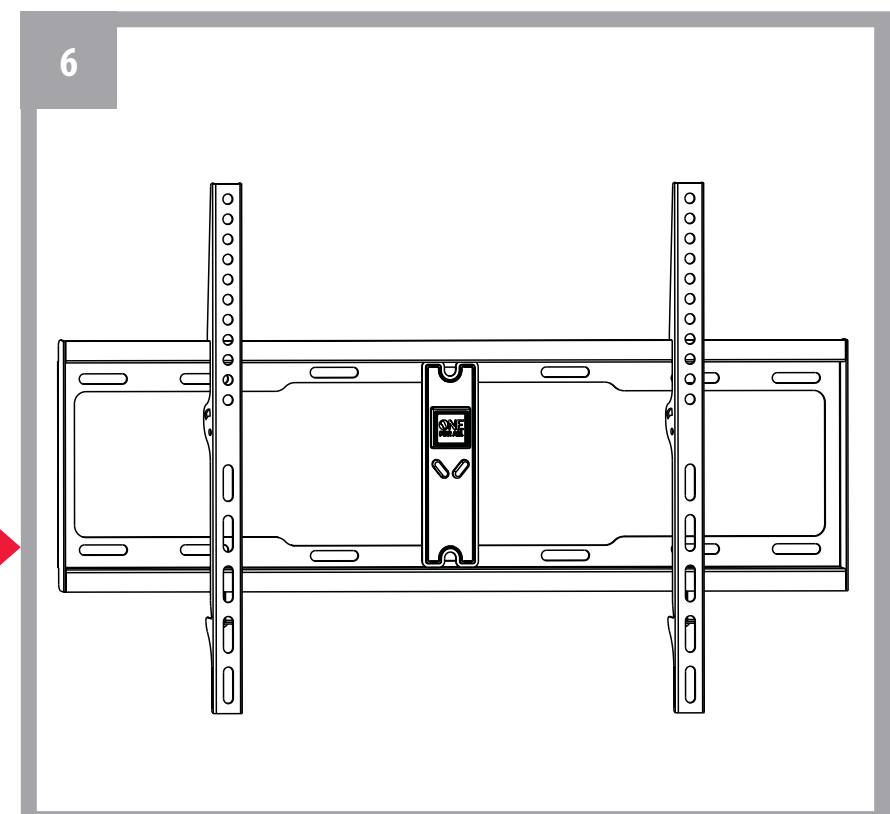
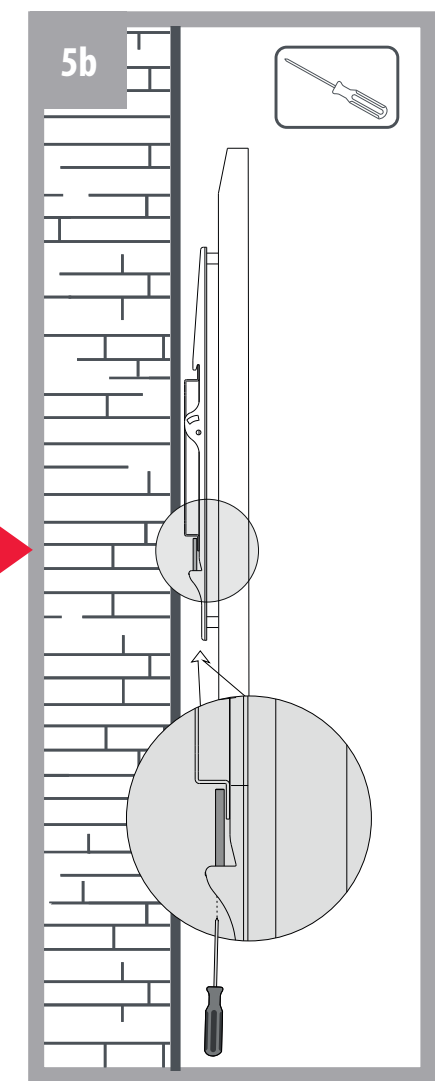
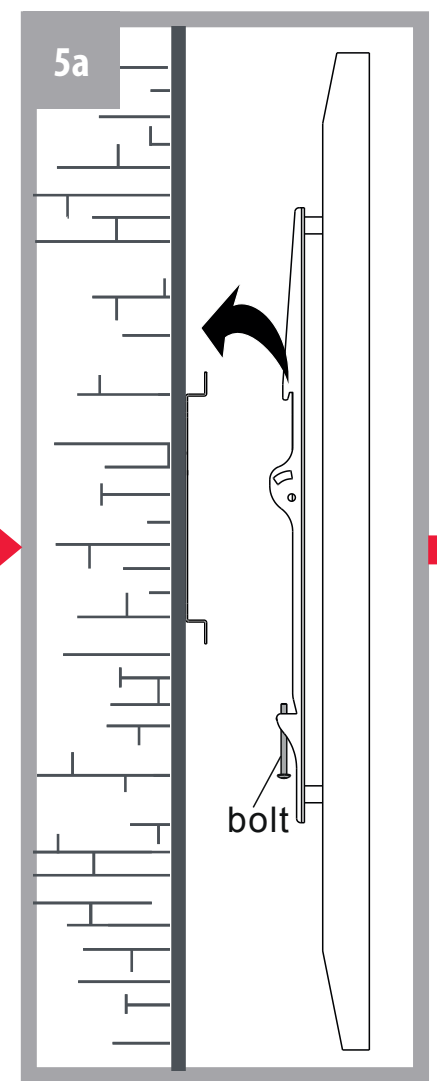
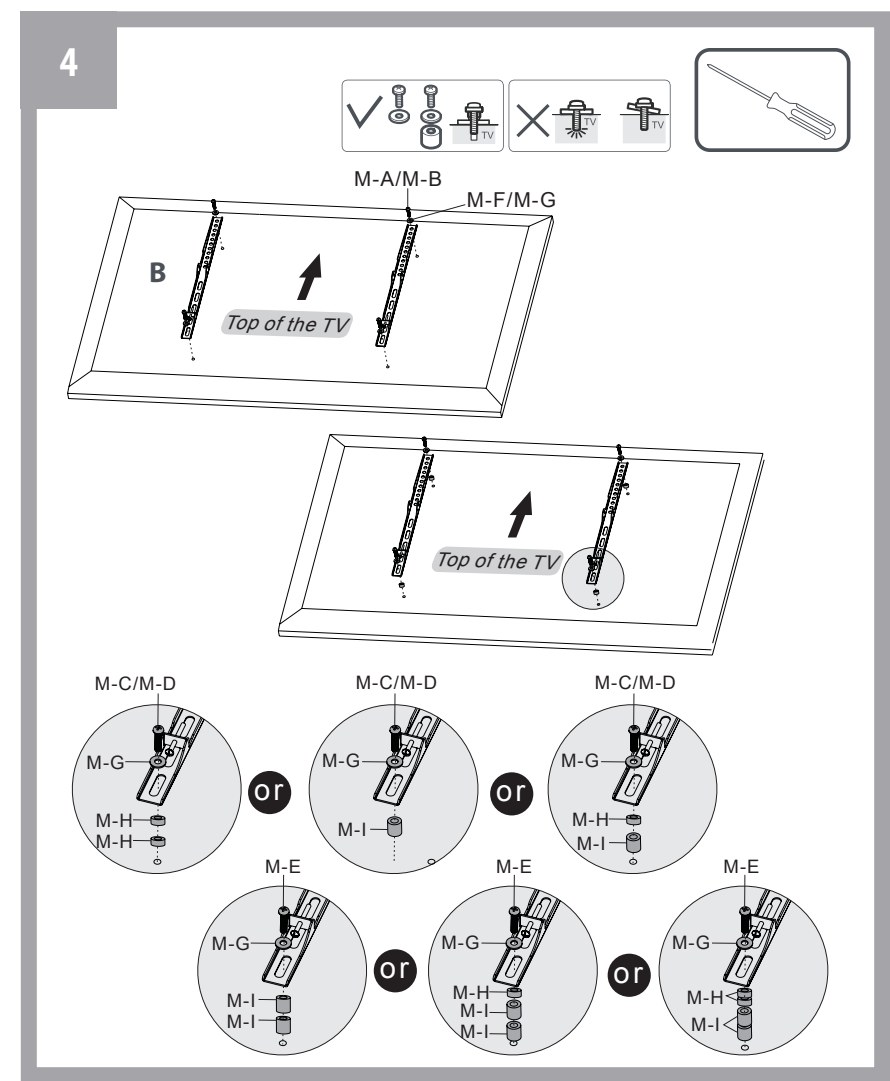
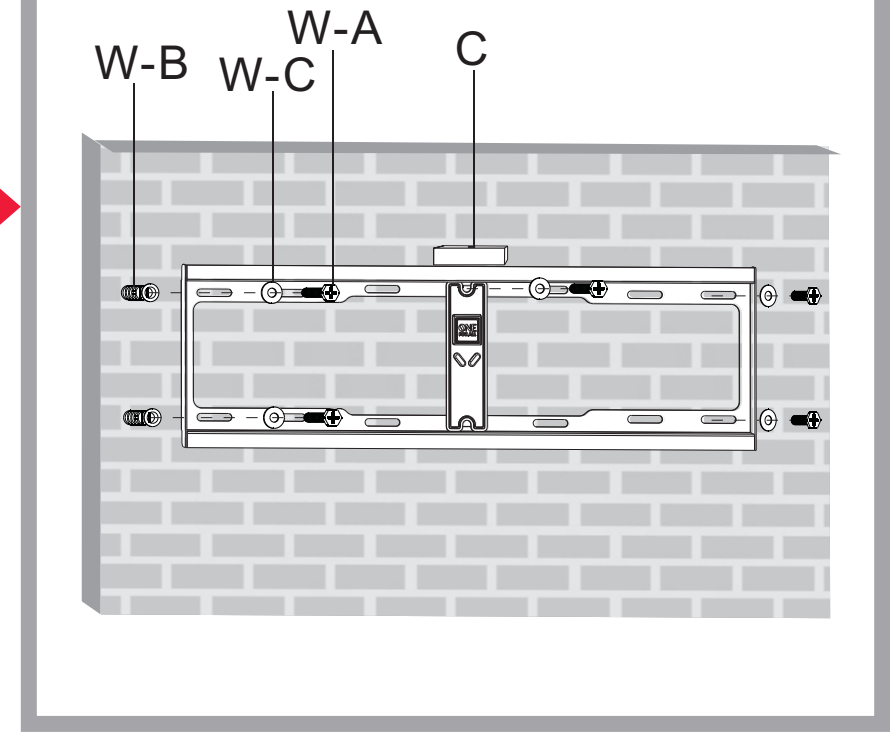

FINISH